

A Celebration in Geophysics  
and Oceanography - 1982

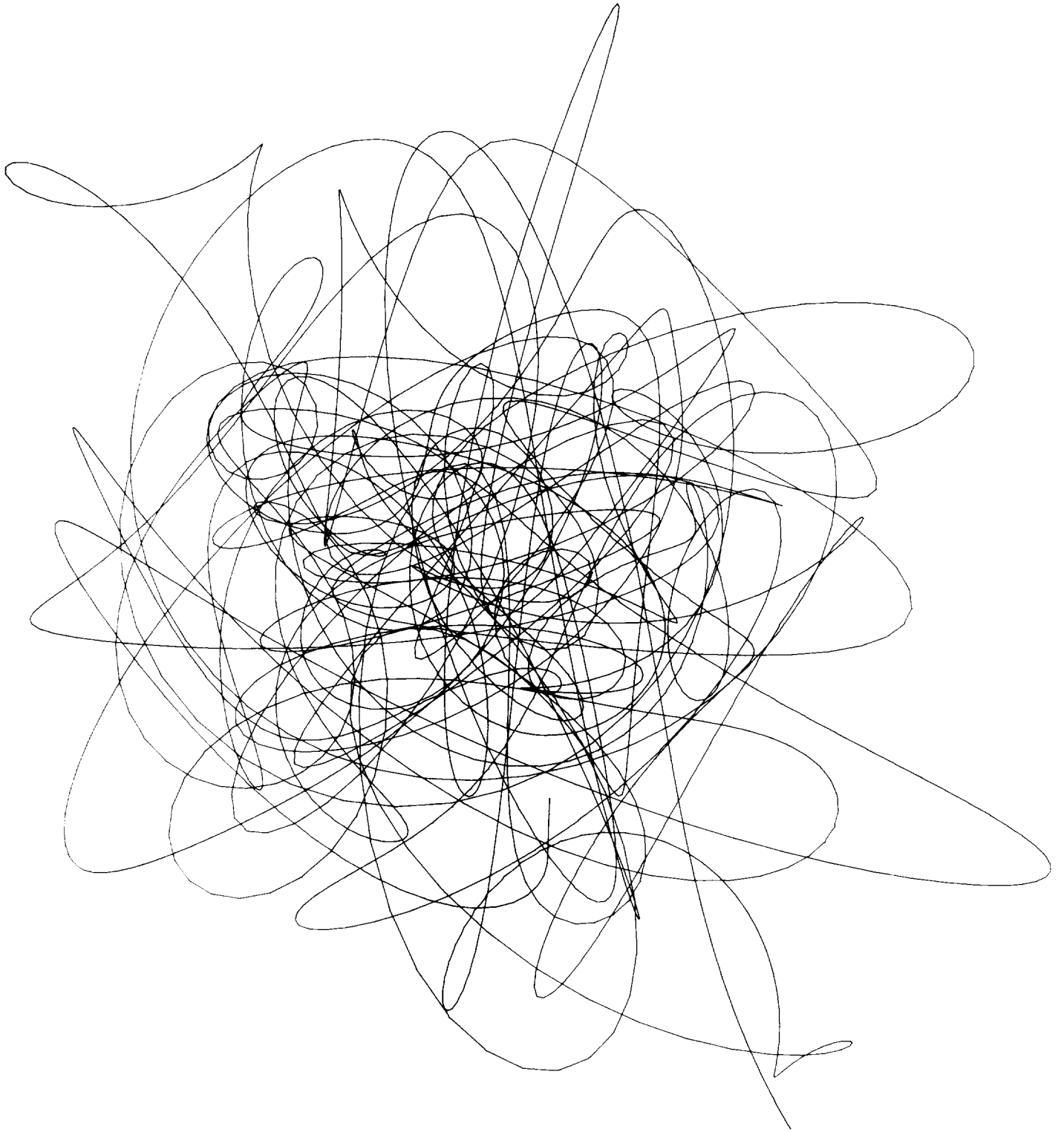

In Honor of Walter Munk



### **Random Walk**

*This plot was generated to simulate the amplitudes and phase variations of the "MIMI" acoustic transmission from Eleuthera to Bermuda; lines passing near the center represent fade-outs. A slide made of this figure is fool-proof: it works equally well in any of its eight possible orientations.*

**“It’s the water that makes you drunk.”\***

**A Celebration in Geophysics  
and Oceanography – 1982**

**In Honor of Walter Munk  
on his 65th birthday  
October 19, 1982**

**at**

**Scripps Institution of Oceanography  
University of California, San Diego  
La Jolla, California**

**Scripps Institution of Oceanography Reference Series 84-5**

**March, 1984**

**Library of Congress No. 84-181943**

\*The title line, which was recounted during these birthday festivities, derives from a dinner during Walter’s earth rotation days. W. Markowitz of the U.S. Naval Observatory told of the logical scientist who set out to determine the cause of drunkenness. On successive days he consumed large quantities of scotch and water, bourbon and water, and vodka and water. Becoming drunk in each case he concluded that the water was responsible. Markowitz went on to find a parallel in the authorship of a number of then-recent papers on the rotation of the earth (e.g. 49, 60, 72 in the bibliography), singling out Walter as the common ingredient in this infiltration of geophysicists into what had been the domain of astronomers.

# CONTENTS

INTRODUCTION.....	1
AFFAIRS OF THE SEA <i>Walter H. Munk</i> .....	3
BIOGRAPHY OF WALTER H. MUNK .....	24
BIBLIOGRAPHY OF WALTER H. MUNK .....	25
THE SCIENCE AND ART OF WAVE PREDICTION – AN ODE TO HO601 <i>Klaus Hasselmann</i> .....	31
TURNING POINTS IN UNIVERSAL SPECULATION ON INTERNAL WAVES <i>Christopher Garrett</i> .....	38
ACOUSTIC TOMOGRAPHY AND OTHER ANSWERS <i>Carl Wunsch</i> .....	47
VENETIAN AFFAIRS <i>Paola Malanotte Rizzoli</i> .....	63
FROM CLOCK-FACES TO ANTI-AMPHIDROMES <i>David E. Cartwright</i> .....	68
SCIENTISTS, SECRECY AND NATIONAL SECURITY <i>Richard L. Garwin</i> .....	71
THE GREENHOUSE EFFECT AND ACID RAIN <i>Gordon J. MacDonald</i> .....	76
NOTES ON THE GENERAL CIRCULATION OF THE OCEANS <i>Peter B. Rhines</i> .....	83
HULA DANCERS, WALTER MUNK AND THE ROTATION OF THE EARTH <i>Kurt Lambeck</i> .....	87
WALTER, ARISTOTLE AND THE TIDES OF EURIPUS <i>Adrian Gill</i> .....	96
STYLES OF SPECTRUM ANALYSIS <i>John W. Tukey</i> .....	100
SOUND TRANSMISSION THROUGH INTERNAL WAVES, INCLUDING INTERNAL-WAVE TOMOGRAPHY <i>Stanley M. Flatté</i> .....	104
THE LUCK OF WALTER MUNK <i>Roger Revelle</i> .....	113
REMARKS IN CELEBRATION OF WALTER MUNK'S 65TH BIRTHDAY <i>Henry Stommel</i> .....	116

## INTRODUCTION

On October 19-20, 1982, a large number of Walter Munk's friends, colleagues, students, and relatives came together at the Scripps Institution of Oceanography for a celebration of his 65th birthday. Contrary to all expectations, Walter was caught completely by surprise when Bill Nierenberg inveigled him, under false pretences, into a packed Sumner Auditorium at 8:30 a.m. on his birthday, 19 October.

The main emphasis at this gathering was on activities that are suitable for any birthday party. However, as an added tribute to Walter, the parties were organized around an informal scientific meeting, a kind of intellectual party, to celebrate the many different and fascinating problems on which he has worked.

A small number of Walter's colleagues were asked to give talks, with the sole injunction that they should be both witty and profound. The presentations covered numerous oceanographic topics and many other things too, from national security to the earth's rotation to laundering statues in Venice. A certain amount of history and philosophy was also apparent, along with stories about Walter that may be based on fact. More of these stories emerged in shorter contributions that were interspersed with the main ones, or presented after dinner.

The purpose of this volume is to preserve many of these talks. Some of the material is entertaining, much is actually interesting and scientifically valuable. We want the volume to stand as a tribute to Walter, a book that he and his colleagues will enjoy reading and that will perhaps convey to students something of Walter's flair for having fun while making serious contributions to important scientific problems.

Consistent with the occasion itself, the written versions of the talks vary greatly in style; virtually no editorial judgments have been imposed on the authors.

It is traditional for a "festschrift" to carry an encomium to the person being honoured. However, this is not a traditional festschrift and Walter is still much too active a colleague for anyone to think of writing his biography. We did want something beyond his sometimes cameo appearance in the lectures, and asked him to update the autobiographical sketch he published a few years ago. This updated version, with additional photos provided by Walter and Judith, opens the present volume. It is followed by Walter's formal biographical listing and complete (as of the time of printing) list of publications. These somewhat dry listings are included to show, most simply, why so many hundreds of people gathered at Scripps in October 1982.

A large number of people had a hand in making the occasion the success it was, and in producing this book. Judith Munk assured us that Walter would enjoy a birthday party and that he would never figure out what was being cooked up behind his back. The local organization was undertaken by Robert Knox, Freeman Gilbert and Bill Nierenberg. Production of this volume has been supervised by Don Betts and Denise Menegus. The Office of Naval Research, through the good offices of Mike McKisic, has helped defray the costs so that widespread distribution is assured. Our thanks to all these individuals and organizations, but principally to Walter for providing the excuse.

Chris Garrett  
Carl Wunsch



# AFFAIRS OF THE SEA

Walter H. Munk

*Institute of Geophysics and Planetary Physics  
Scripps Institution of Oceanography  
University of California at San Diego  
La Jolla, California 92093*

The following pages are taken from an introductory chapter written at the request of the Editors of the *Annual Review of Earth and Planetary Sciences*.\* This chapter was written on a skiing vacation at San Vigilio di Marebbe; it provided a ready excuse for coming off the mountain in the early afternoon, before it got cold and icy. Only after the

chapter was published did I realize that I had failed to even mention the ill-fated MOHOLE project (perhaps because I have been trying to forget it for twenty years). This omission is now remedied. There are several other modifications, and the account is brought up-to-date.\*\*



*I associate most of my boyhood prior to coming to America with life at the Eggelgut, in Altaussee, a village about 45 minutes out of Salzburg. My grandfather converted and enlarged a 17th century peasant house to the Eggelgut, located on a steep meadow between the forest and a brook. Life was centered around the lake, and around the tennis courts. I took tennis very seriously and once made it to the Austrian semi-semi finals for junior doubles. In winter we would ski on the Loser which started right behind the house. After the war Mother sold the house and most of the land, but we still visit there occasionally.*

\*Reproduced, with permission, from the *Annual Review of Earth and Planetary Sciences*, Volume 8, © 1980 by Annual Reviews, Inc.

\*\*References to papers in which I am an author are numbered in accordance with the Bibliography in this volume.



*This picture was taken on the Dachstein, a 3,000 meter high mountain not far from Altaussee. I never was any good at rock climbing; it scared me to death, so I was glad to stop when I became old enough to do so.*

### Prologue

I was an unlikely person for a career in oceanography. When I was born in Austria in 1917 the country had already lost its tenuous hold on a last piece of coastline. My maternal grandfather was a private banker in Vienna, and left enough to provide adequately for his five children, but not for his grandchildren. In 1932, at the age of fourteen I was sent to a boys' preparatory school in upper New York state to finish high school, and to be subsequently apprenticed to a financial firm my grandfather had helped to found. I barely managed the preparatory school; it went bankrupt the following year. I then did a three-year stint at the financial firm; the firm folded the year after.

Somehow I talked my way into Cal Tech and graduated in 1939 in "Applied Physics". At the time I was in love with a Texas girl who vacationed in La Jolla, so I applied for a job at the Scripps Institution of Oceanography in the summer of 1939. The Texas romance has been outlasted for some forty years by my romance with oceanography. In 1950, when I declined an offer by C.-G. Rossby to join his Department of Meteorology at the University of Chicago, Rossby told me that "anybody with any imagination changes jobs once in a decade." But I am still here!

I loved Scripps from the time I spent the first night at the Community House, on the site now occupied by the Institute of Geophysics and Planetary Physics. Harald Sverdrup, the famed Norwegian Arctic explorer, was Director. The staff, including one secretary and a gardener, totalled about 15.



*1939. When I came from Cal Tech for the summer I lived at the Community House, now the site of IGPP. Scripps was isolated from La Jolla; there was only one house in what is now called La Jolla Shores.*





1940. With Harald Sverdrup in George Scripps Hall. Harald Sverdrup, the Director of Scripps, was then working on his epic "The Oceans". The total Scripps staff consisted of 15 people, including the gardener. For a while I was the only student. Harald Sverdrup and his wife, Gudrun, remained my life-long friends. Harald was a wonderful teacher; among other things he taught me how to write English (he was Norwegian).

After the first summer, I went back to Cal Tech for a Master's Degree in Geophysics under Beno Gutenberg. But next summer I was back at La Jolla, requesting to be admitted for study towards the PhD Degree in Oceanography. Harald Sverdrup gave my request his silent attention for an interminable minute, and then said that he could not think of a single job in oceanography that would become available in the next ten years. I promptly enrolled, and for some time I constituted the Scripps student body.

This was the time of the German occupation of Austria, and a general war seemed imminent. I enlisted in the US Army, and spent 18 months in the Field Artillery and the Ski Troops. Peacetime service became dull, and I was glad when the opportunity came to join Harald Sverdrup, Roger Revelle, and Richard Fleming in a small oceanographic group at the US Navy Radio and Sound Laboratory at Point Loma (now NOSC). A week later Japan attacked Pearl Harbor. For the next six years I worked on problems of amphibious warfare.

I did not get back to the PhD dissertation until 1947, and then only under threat of dismissal. My thesis was written *de novo* in three weeks (see reference 6 of Bibliography) and is the shortest Scripps dissertation on record. As it turned out, its principal conclusion is wrong (15). In 1979 when UCLA (where Scripps degrees were awarded in the forties) called to offer me the Distinguished Alumnus Award, I thought for a moment they were going to cancel my degree.

During my career I have worked on rather too many topics to have done a thorough job on any one of them; most of my papers have been superseded by subsequent work. But "definitive papers" are usually written when a subject is no longer interesting. If one wishes to have a maximum impact on the *rate* of learning, then one needs to stick out one's neck at an earlier time. Surely those who first pose a pertinent problem should be given some credit, and not just criticized for having failed to provide the final answer.



1940. Rowboat. My first oceanographic outing.

The underlying thread to my work consists of a theme and some habits. The theme is a kind of Earth spectroscopy: to collect long data series and then to perform spectral analysis of high resolution and reliability. We developed a system of computer programs (91) called BOMM (for Bullard, Oglebay, Munk, and Miller), which at one time was widely used. The procedure has been rewarding in the studies of ocean waves and tsunamis, tides, Earth wobble and spin, variations in gravity, and the scattering of sound and radio waves. Oceanographers have long been familiar with discrete spectra, but when I entered the field the corresponding analysis of continuous (or noisy) processes was not familiar (although it had been applied in optics and acoustics for generations). The reason, I believe, has to do with the difficulty of measuring very low frequencies with resonant analog devices. The analysis did finally become routine, but not until corresponding numerical methods had become accessible through the development of fast-speed computers.

Now to turn to the habits:

1. I do not spend much time in polishing lectures. The excuse is that, in a small class, students learn more if they

participate in halting derivations and have the joy of pointing out blunders, than if they are handed the subject on a silver platter. As a student, I listened to a series of lectures by a famed Scandinavian geophysicist who had selected each word in advance, including the layout of the blackboard. I found those lectures extremely dull.

2. I become intrigued with new techniques (spectral analysis, array processing, sensitive pressure transducers, radio backscatter, acoustic sensing) before knowing what purpose they might serve. It is a case of a solution looking for a problem. Here my excuse is that if you can apply a significant technical innovation to a field of general interest, then you cannot help but learn new things. I do not propose this procedure to everyone, but for me it has worked well.
3. I do not like to read. The outcome has been that I have entered fields with little or no modern literature; in a number of cases I left the field some ten years later in a state of lively activity and an increasing rate of publications.

### Waves and the War, 1942-1950

In 1942, Harald Sverdrup and I were told of the Allied preparations for an amphibious winter landing on the northwest coast of Africa. The coast is subject to a heavy northwesterly swell, with breakers exceeding six feet on two out of three days during winter. Yet practice landings in the Carolinas were suspended whenever the breakers exceeded six feet because of broaching of the LCVP landing craft. The problem, simply put, was to pick the one out of three days when the waves are suitable for landing.

We started work to predict waves on the basis of weather maps. The prediction consisted of three steps. (i) The height  $H$  and period  $T$  of the storm-generated sea were related to the wind speed  $U$ , the storm fetch  $F$ , and duration  $D$  through four dimensionless relations:

$$\frac{gH}{U^2}, \frac{gT}{U} \text{ as functions of } \frac{gF}{U^2}, \frac{gD}{U}.$$

(Waves are either fetch-limited or duration-limited.) We scrounged together observations from oceans, lakes, and wave tanks and came out with rather pleasing scatter plots (2) extending over 6 octaves in  $gF/U^2$ . (ii) Subsequent attenuation beyond the storm area was estimated from wave dispersion and geometric spreading. (iii) The transformation in shallow water was computed from principles of conservation of energy flux (3). This method for predicting sea, swell, and surf was taught to classes of Navy and Air Force weather officers, and was applied widely to amphibious landings in the Pacific and Atlantic theaters of war. For the Normandy invasion, the waves were correctly predicted to be high but manageable.

The empirical relations have held with minor modifications to the present day. The principal shortcoming is that a complex wave spectrum is poorly described by just two parameters, height and period. (Pierson and Neumann subsequently extended the prediction to the entire wave spectrum.) We tried to calibrate the predicted heights and periods in terms of estimates by coxswains during landing exercises, and to compare these estimates to wave records taken at the same time and place. This led to the definitions of *significant* heights and periods as being appropriate to the averages of the highest third of the waves present.

These were exciting and rewarding times. In retrospect, we should not have sanctified our work by calling it a *theory* of wave prediction; it was empiricism, pure and simple, with a few dispersion laws thrown in. There is still no theory giving the observed wave dimensions, notwithstanding the important contributions by Phillips and Miles, though Hasselmann's work on nonlinear wave coupling has come close to providing the right magnitudes.

At the end of this period, we applied what we had learned to geologic processes in shallow water (4), and took a first stab at calculating long-shore currents from obliquely incident waves (17). I earned some consulting money by calculating wave forces on offshore structures (10) according to  $au^2 + b \cdot du/dt$ , with  $u$  designating a horizontal component of orbital velocity. The wave climate was established from hindcasts based on historical weather maps. One drilling rig for which I had calculated the wave forces collapsed in a storm.

### Wind-driven Ocean Gyres, 1949-52

I worked next to Harald Sverdrup's office when he discovered the relation  $\beta M_y = \text{curl} \tau$  between the northward water transport  $M_y$ , the wind stress  $\tau$  and the northward variation  $\beta = df/dy$  of the Coriolis parameter (Sverdrup 1947). Sverdrup had been analyzing observations of equatorial currents (where the geostrophic balance is singular). He did not derive the so-called "Sverdrup relation" systematically, but rather found it by playing with known equations. The result was in accord with observations. Sverdrup was worried for months about the simplicity of the result; how could it have been overlooked?

Only a year later, in 1948, Henry Stommel (1948) published his beautiful demonstration that the western boundary currents are associated with  $\beta$  rather than  $f$ . Stommel's equations reduce to the Sverdrup relation away from the boundaries, but he was unaware of Sverdrup's work when he wrote his paper. In 1950 I combined Sverdrup's and Stommel's formalisms, but used a horizontal eddy viscosity  $A$  rather than Stommel's linear bottom friction (20). (In some ways this obscures the simplicity of Stommel's vorticity balance.) In this way the zonal wind distribution, from the polar easterlies to the westerlies to the trades and the doldrums, could be readily associated with the global features of the ocean circulation; I used the term "ocean gyres" which has stuck in the literature ever since.

The paper gives a simple expression for the total transport of the western boundary current:  $\beta^{-1} \int dx \text{curl} \tau$  with the integration east to west across the oceans. This gave  $36 \times 10^6$  m<sup>3</sup>/s for the Gulf Stream. At the time the observational estimates gave  $74 \times 10^6$  m<sup>3</sup>/s. I thought the discrepancy by a factor of two might be a metric factor associated with the assumption of north-south oriented ocean boundaries, but was unable to solve this problem until I met George Carrier who did it in five minutes (22): the transport is not affected by boundary inclination. The problem is greatly simplified by Carrier's boundary layer technique, and this made it possible to tackle the slightly non-linear problem (23).

### Earth Wobble and Spin, 1950-1960

One way to study the planet Earth is to observe irregularities in its rotation. In this manner one can learn about the growth of the core, the variable distribution of glaciation, air and water mass, global winds, bulk viscosity, and so forth. In each case the information is related to certain integral quantities (moments) taken over the entire globe. This is the weakness of the method — and its strength.

Astronomers were the first to attempt to exploit, for geological purposes, the irregularities they had discovered. They did this in the naive faith that the simplicity of celestial mechanics could be carried over to messy objects like the Earth. To account for inconsistencies in the latitude measurements they spoke of the "proper motion" of observatories; and to explain a rather sudden decrease in the Earth spin around 1920, they pushed up the Himalayan complex by one foot.

My interest in this subject was first aroused by a statement in 1948 by Victor Starr that a seasonal fluctuation in the net angular momentum of the atmosphere must be accompanied by "...undetectable inequalities in the rate of the Earth's rotation", the net angular momentum of the planet Earth being conserved. How big is undetectable? I started reading about clocks, and learned that M. and Mme. Stoyko of the Bureau de l'Heure in Paris had in fact discovered in 1936 that the length of day in January exceeds that in July by 2 ms. This was based on precision pendulum clocks, and subsequently confirmed with crystal clocks. A very simple calculation showed that this measured variation agreed in amplitude and phase with that inferred from the seasonal wind variation (21). Within a year we learned that the meteorologists had overestimated the strength of the westerly jets, and the inferred variation in the length of day came down by a factor of three (27). Three years later the astronomers found periodic errors in the right ascensions of the FK3 catalogue, and this led to a similar reduction in their estimates. The conclusion was the same as it had been in the first place, that a seasonal variation in the length of day is largely the result of a seasonal variation in the westerly winds (42). And so it stands today.

There was a curious dichotomy between those who measured latitude and so inferred the *wobble* of the Earth relative to a rotation axis fixed in space, and those who compared sidereal time to ephemeris time (later to atomic time) and thus inferred the variable *spin*. But wobble and spin are the three components of one vector, and for geophysical processes the observations of latitude and time had better be discussed together. For example, by considering the relative magnitude of the three components, Revelle and I put some upper bounds on the melting of the Greenland ice cap (33), and we suggested that the surprisingly large decade variation in the Earth's spin (without discernible wobble) could be related to variations in the angular momentum of the fluid core. After five years of scattered publications touching many diverse aspects of geophysics, I joined forces with Gordon MacDonald to prepare an encompassing geophysical discussion of the rotation of the Earth (72). This is now an active field, and I am pleased that a book by Kurt Lambeck (1980) has come out, following ours by just 20 years. One of the most interesting topics involving the Earth's rotation is the problem of tidal friction. This topic is intimately connected with the evolution of the Earth-Moon system. We estimated the tidal dissipation at  $3 \times 10^{12}$  watts from the modern astronomic observations, about the same from Babylonian eclipses, and  $2 \times 10^{12}$  watts from oceanographic measurements. By now (Lambeck 1980) the Babylonian observations have been reworked, additional ancient observations have been uncovered, and the global ocean tidal models have given much tighter estimates. Artificial satellites have provided independent evidence. Prehistoric data on tidal friction are now obtained by counting the number of daily striations per annulation in corals, going back to Devonian times when the year had 400 days. As I understand it, all the evidence is now consistent with a dissipation rate of  $3.6 \times 10^{12}$  watts.

#### MOHOLE, 1957-1964

In spring of 1957 the initial NSF panel on Earth Sciences had just sat through two days of reviewing sixty-five proposals when the question came up: if cost were no object, what would be the project that could lead to the greatest advance in understanding the Earth? Harry Hess and I suggested the collection of a sample of the Earth's mantle. The place to do it is under the sea where the overlying crust is relatively thin, typically 5 km. The required development for keeping the drilling vessel in place, and of re-entering the hole, if necessary, seemed within reach of the existing acoustic technology.

One month later the American Miscellaneous Society was having a spontaneous breakfast in our patio. AMSOC was founded by Gordon Lill, John Knauss and Art Maxwell to maintain cooperation with Visitors from Outer Space, for Informing Animals of their Taxonomic Positions, and for other such purposes. The Society is internationally known for the Albatross Award, a stuffed bird presented at irregular intervals to an oceanographer for some "unusual achievement" (I am a proud Albatross Laureate). There are no Society bylaws, no dues, no officers. Our discussion turned to the deep-sea drilling venture which was promptly named MOHOLE, in honor of Andrija Mohorovicic, a Yugoslavian seismologist who discovered the discontinuity between crust and mantle. An AMSOC deep-drilling committee was formed on the spot, consisting of Lill, Revelle, Tracey, Ladd, Hess and me; later that month Ewing, Rubey and Maxwell were co-opted. The Committee was charged with making a \$50,000 proposal to NSF for a feasibility study. The Foundation did not decline outright, but suggested that it would entertain a proposal from the same group if they attached themselves to a more substantive organization. And so the nine of us became the AMSOC Committee of the National Academy of Sciences. I.I. Rabi, who was on the Academy Council, remarked: "Thank God, we're finally talking about something besides space."

It took another year until we received a \$15,000 down payment from the Foundation. Willard Bascom became Director of the NASAMSOC staff, and he, Robert Taggart, Jack McLelland, Francois Lampietti, Ed Horton and others went to work. By 1961 they were drilling just east of Guadalupe Island in 12,000 feet of water.\* The story is told by Bascom (1961).

The completion of the Guadalupe drilling ended Phase I of the MOHOLE project. The drill had penetrated 560 feet of sediment and a few feet of basalt. The drilling vessel, CUSS I of Global Marine, had performed admirably; the vessel was constantly "underway", driven by four large outboard propellers to maintain a fixed position relative to three sonic bottom transponders, the first example of "dynamic positioning". The weather was poor but things worked, a tribute to Willard Bascom. John Steinbeck and Fritz Goro were along to record the event for LIFE magazine. I remember that it was very noisy, and that we all lost our voices. But the spirit was high. When Bascom wired President Detlev Bronk of the National

\*Years later as a result of the Deep-Sea Drilling Project it was learned that the site chosen was on a tiny fragment of the Farallon plate.

Academy that we had reached basalt, we all thought MOHOLE was in the bag. Later I was to realize that from this moment on the project was doomed.

Phase I was completed on time, and within the allotted budget of \$1.7 million. The mantle drilling, Phase II, was estimated at \$40 million. The NASAMSOC Committee recommended that a prime contractor be chosen for Phase II, leaving the selection process entirely in the hands of the Foundation. It was taken for granted that the Bascom group which had performed so well under Phase I would continue to play a key role. Industry, which had been on the sidelines until the Guadalupe drilling, now showed a marked interest. On 17 July 1961 some 200 people representing 84 companies attended a briefing in the NSF Auditorium. NSF called for proposals to include information on experience with experimental research projects. William Benson, who represented NSF, stated that "any good bidder will want the AMSOC staff". There was an impression that NSF would give preference to no-fee, "all-for-science" proposals. By the time of the deadline — September 11 — ten proposals were received, including:

1. Socony Mobil, with General Motors, Texas Instruments and Standard Oil of California,
2. Global Marine Exploration, with Aerojet-General and Shell Oil.

These two proposals received the highest ratings, more than 900 out of 1,000 points, from a NSF evaluation panel. A proposal by Brown and Root, a Houston based engineering and construction firm, came in one week before the deadline and was placed fifth with 801/1000 points. The panel recommended the Socony Mobil proposal to NSF Director Waterman as being "in a class by itself". Socony spent \$150,000 of their own money on preliminary technical studies and had not asked for a fee; Brown and Root asked for a fee of \$1.8 million. Brown and Root did not have, nor did it claim, any in-house technical off-shore capabilities. When questioned about this, Herman Brown is said to have replied: "I can always hire an acre of engineers."

It is now history that the contract was awarded to Brown and Root. Three years later, with \$50 million spent and no results, the project folded.

There has been much controversy as to what happened; Solow's (1963) article in FORTUNE gives a good account. After the award the controversy centered on the technical competence of the people in charge (as Bascom's group was gradually removed from the project) and on Brown and Root's insistence on going for a 1 shot — 1 hole operation. The NASAMSOC Committee, under the able chairmanship of Hedberg, favored a gradual approach with sedimentary drilling evolving into deeper and deeper holes. Academy President Seitz chose not to publicly support the AMSOC position, and the decision making shifted to the NSF staff. The argument for one, two, or N holes was resolved when MOHOLE became NOHOLE.

I walked away with the determination never again to participate in a project unless I was willing to give it the time required. It was foolish to expect that I could continue my job at Scripps as usual and still play a useful role in the MOHOLE project. MOHOLE might have worked if we had



Photo by Fritz Goro

1961. Aboard the *CUSS I* during PROJECT MOHOLE. From left to right: Roger Revelle, Willard Bascom, Walter Munk and Gustav Arrhenius. We were then "dynamically anchored" east of Guadalupe Island on the first deep sea drilling station.

not abdicated our responsibility. In 1962, I wrote to Hedberg: "Scherer, Sheppard, and Benson (of NSF) have now replaced the AMSOC Committee in its important functions; the only legitimate question is whether they are more qualified or less qualified than AMSOC to make the essential decisions. Were the chances for success enhanced when the project was removed from the authority of an independent group to an in-house NSF activity? And were the young men who gathered under Bascom's daring and devoted (though sometimes willful) leadership less qualified than an amorphous engineering firm which had demonstrated no previous scientific interest in the MOHOLE venture, or as far as I know in any scientific problem? I have never been able to learn on what grounds the direct approach of a few highly skilled people, which served so successfully in Phase I, had to be replaced by the 'acres-of-engineers' philosophy."

Ten years after the MOHOLE demise, the Deep-Sea Drilling Project initiated an enormously successful ocean-wide sediment drilling program with the GLOMAR CHALLENGER (operated by Global Marine) for a drilling vessel. The problem of re-entry was solved. Going to the mantle does not seem as urgent now as during the MOHOLE days.

As this is being written, the question regarding the degree of NSF in-house involvement in deep-sea drilling has arisen once again. Vannevar Bush was worried about this very

problem when NSF was founded in 1950. I think the solution, then and now, is for NSF to resist the temptation of *managing* any of the NSF-supported research programs.

### Sun Glitter and Radar Clutter

In 1953, Charles Cox and I spent the better part of a year measuring the statistics of surface slopes from photographs of sun glitter. The principle is simple: if the sea were glassy calm, the reflected sun would appear only at the horizontal specular point. In fact, there is a myriad of sun images wherever a surface facet is appropriately tilted to reflect the sun into the camera. The horizontal specular point at the center of the glitter is brightest because the probability of zero slope is highest. The outlying glitter is from the steepest facets that are the least probable. On a windy day when the slopes are relatively steep, the glitter area is large. The slope statistics are readily derived from the distribution of intensity (film density) about the specular point (44).

We managed to get an Air Force B17 (Flying Fortress) and started to work off Monterey. There was plenty of wind, but no sun. We then transferred to Maui, Hawaii, where we had plenty of sun but no wind. Finally, on the last available flying day, we recorded over the Alenuihaha Channel with winds up to 30 knots.

It was found that up/down wind components in mean-square slope exceeded the crosswind components by only a factor of two, and that both components increased roughly linearly with wind speed. These results have been found useful in a variety of different problems. Twenty-five years later Blyth Hughes *et al.* (1977) repeated the measurements by a quite different method, but with substantially the same numerical results.

What was missing in the glitter experiment is a measure of the relative contribution to the mean-square slope from waves of different lengths (e.g. the slope spectrum). The strength of the glitter experiment is that it provides a useful statistic directly, in contrast to the usual procedure for taking long data series and subsequently performing statistical analyses. I was on the lookout then for an equivalent method that could give *spectral* distributions directly. At just about this time, Crombie (1955) conducted such an experiment in New Zealand at the suggestion of Norman Barber. Crombie backscattered radio waves from the sea surface. For a resonant interaction both wavenumbers and frequencies must add up:

$$k_1 + k_2 = k_3, \quad \omega_1 + \omega_2 = \omega_3.$$

Subscripts 1 and 3 refer to the outgoing and backscattered radio waves, and 2 to the resonant ocean wave. For a radio backscatter,  $k_1 = -k_3$  and so  $k_2 = 2k_3$ . The associated ocean wave frequency is  $\omega_2 = \sqrt{gk_2}$ . But for resonance  $\omega_2 = \omega_3 - \omega_1$  is the radio Doppler shift. Thus for a given radio wavelength  $2\pi/k_3$ , the radio Doppler shift is predicted at  $\sqrt{g2k_3}$ , and this was beautifully confirmed by Doppler measurements.

With modern equipment the Doppler line is 50 dB above background, and there is not much that one cannot do with 50 dB signal-to-noise ratio. Robert Stewart found a slight departure of the measured Doppler from the predicted

Doppler, and demonstrated that this slight departure was due to surface current. For a radio wavelength,  $\lambda$ , and resonant ocean wavelength,  $\frac{1}{2}\lambda$ , the current is measured to an effective depth,  $\frac{1}{2}\lambda/2\pi$ . By conducting the measurements at a series of radio wavelengths, Teague, Tyler and Stewart (1977) could estimate the current shear. By placing the radio receiver on a moving jeep one can form a synthetic aperture and measure the directional distribution of ocean waves (139). Very roughly this falls off with angle  $\theta$  measured relative to the wind like  $\cos^2(\frac{1}{2}\theta)$  at relatively high winds and high frequencies. We had guessed at something of this sort in our original wave-prediction scheme (2).

W. Nierenberg and I got a joint Stanford-Scripps effort underway, and participated in some of the analyses. We showed (116) that the radar backscatter cross section  $\sigma = k^4 F(k)$  is a direct measure of the saturation constant  $B$  for the Phillips surface wave spectrum  $F(k) = Bk^{-4}$ . This connects two independently measured empirical constants: the typical "-23 dB" backscatter cross section of the sea surface, and the saturation constant 0.005. I believe that the opportunities for gathering ocean wave statistics by radio backscatter have by no means been exhausted.

### Southern Swell, 1956-1966

To the delight of the surfing community in California and Hawaii, occasional trains of tremendously long and regular swell roll into shore in the summer months. As part of the University wartime wave activity, John Isaacs had arranged for aerial photographs to be taken over California beaches. One of these pictures provided a textbook example of regular undulations being transformed over the shelf. Working backwards and allowing for wave refraction in shallow water, I estimated a deep-water direction of SSW, and a deep-water length of 2000 feet! The inference was that we were seeing the effect of storms in the southern hemisphere winter, some 5000 nautical miles away. There had been evidence in the Atlantic of ocean swell coming from very far away, particularly as a result of the work of Norman Barber and Fritz Ursell in the U.K. Could ocean swell provide useful information about distant storms (29)?

Frank Snodgrass came to La Jolla in 1953 in what was to be a wonderful partnership for the two of us for over 23 years. He adapted a "Vibrotron" transducer to measuring pressure fluctuations on the shallow seafloor, the purpose being to explore oscillations with frequencies even lower than those of the swell. We anchored off the Mexican island of Guadalupe for a week (57). Frequency analysis of the records (using an IBM 650 at Convair) showed a series of "events" starting with 1-mm waves of 50-mHz frequency, and ending a few days later with 10-cm amplitudes at 80 mHz. We computed the source distance and time as follows: the group velocity for waves of frequency  $f$  is  $g/(4\pi f)$ . This means that a wave disturbance travels at group velocity  $v$  over a distance  $x$  in a time  $t - t_0$ :

$$v = \frac{x}{t - t_0} = \frac{g}{4\pi f}, \quad \text{or} \quad f = \frac{g}{4\pi} \frac{t - t_0}{x}.$$

The slope of the line  $f(t)$  gives the source distance  $x$ , and the zero intercept gives the source time  $t_0$ . And here it was,

a distant southern swell (even though we had anchored on the eastern side of Guadalupe Island). But there was one problem: one of the events gave a source distance of half the Earth's circumference, and even though the Pacific is big, it is not that big. Could it be that the waves had originated in the Indian Ocean and had traveled half way around the world along a great circle route, entering the Pacific between Antarctica and New Zealand?

I had by then become fascinated with array theory developed in radio astronomy, and was anxious to try it out in the oceans. Snodgrass installed a triangular array off-shore from San Clemente Island (85). The results were spectacular. The very far wave sources all were within a beam from 210° and 220° true, which is the angle subtended by the window between Antarctica and New Zealand, as seen from San Clemente. (I am not suggesting this as a method for remote sensing of Southern Hemisphere geography.)

This led to the final and most ambitious of these undertakings (96). We established six wave stations along a great circle route from New Zealand to Alaska to track wave packets originating in the great southern storm belt. Frank Petersen

took the station at Cape Palliser, New Zealand. I monitored from Samoa, where my daughters Edie and Kendall (ages 4 and 2), my wife, and I lived in a palm *fale* in the village of Vailoa Tai at the southwestern coast of Tutuila. Gordon Groves and a radio operator went to the uninhabited equatorial island of Palmyra. Klaus Hasselmann recorded at Hawaii. The floating instrument laboratory FLIP was stationed north of Hawaii, to make up for the lack of coral islands in the cold northern Pacific. Our one graduate student at the time, Gaylord Miller, volunteered for Yakutat, Alaska. Snodgrass established the stations, using seafloor pressure recorders connected by cable to shore-based digital paper punches. We recorded for three months with 98% data return. Gordon Groves got into a battle with his radio operator, whom we had to take off the island by plane. FLIP ran out of cigarettes and I had some problem keeping them on station for another two weeks (via amateur radio).

The stations were spaced with the preconceived view that the principal loss in wave energy would be by wave-wave interaction as the southern swell crossed the tradewind sea. As it turned out, the energy loss was virtually complete



Photo by Fritz Goro

1961. Kendall, Edie and Judith in our patio.



1963. Measuring ocean swell from a fale in Tutuila, America Samoa. I persuaded Judith to take the 0400 daily watch of swell recording.

within one diameter of the southern storms. Beyond that, for the next 10,000 km, the loss was less than 2 dB and not measurable beyond the effects of geometric spreading and dispersion.\*

As far as I know there has been no further work along these lines for about 20 years. With the advent of a radio altimeter on SEASAT it has become possible to measure wave height from the sharpness of the leading edge of the reflected signal. The maps produced by Nellie Mognard *et al.* (1982) beautifully show the penetration northward into the Pacific Ocean of wave disturbances in the southern oceans.

\*The National Science Foundation funded an educational film, "Waves Across the Pacific," which was widely distributed. I am pleased with the film but not the script: for once I would like to see a film about oceanography which shows it as it is. Things do not turn out as planned; improvisation is a way of life. The final lesson is hardly ever a response to the pre-expedition question.

#### Surfbeats, Edge Waves, and Tsunamis, 1958-1965

Between the ocean swell and the tides there were 10 octaves of unexplored frequency space, only occasionally excited by storm "tides" and by earthquake tsunamis. We found sea level oscillations of 1 to 2 minute periods at the foot of Scripps pier: these were clearly related to *groups* of incoming swell (19), e.g. the frequency  $f$  of this "surfbeat" equals the bandwidth  $\Delta f$  of the incoming waves. This experience gave Klaus Hasselmann, Gordon MacDonald and me a first opportunity to practice a generalization of power-spectral analysis to nonlinear processes (83), following an important suggestion by John Tukey.

Frank Snodgrass was anxious to apply his experience in measuring bottom pressure fluctuations of low amplitude and low frequency to this part of the ocean wave spectrum. He installed a longshore array of transducers to determine the dispersion relation  $\omega(k)$  in the frequency range 0.5 to 60



cycles per hour (cph). The empirical  $\omega(k)$  was then compared to a theoretical  $\omega(k)$  for gravitationally-trapped edge waves. The agreement is so good (89) that I suspect readers have simply assumed that the plotted curves were fitted to the empirical points, rather than having been derived independently. (This might explain why the paper has not been noticed.) It is my only experience of an oceanographic experiment that gave unequivocal confirmation to a previously derived theory.

This work gave us the impetus to explore the low-frequency wave background on the California continental borderland, away from the coastal edge. The result was a dull, featureless, and quite reproducible spectrum (78) which forms the background to the tsunami studies subsequently conducted by Gaylord Miller (79). The source of this background is not known.

We pushed the measurements to lower and lower frequencies, down to the tide and eventually through and beyond the tidal line spectrum (86).



*December 1968. The Faculty gave a reception for the new UCSD Chancellor William McGill at the Scripps family residence Miramar. I was then Chairman of the Faculty. The inauguration was followed by two turbulent years of student unrest.*



*1969. In our patio. From left: Edie, "Heavy" Palchek (the Student Body President), W.M., Judith, Sam and Kendall.*

### Tides, 1965-1975

The incentive to go seriously into tides came from a number of directions. The study of Earth rotation had provided the initial fascination with the global dimensions of bodily and fluid tides. Further, the ultimate limit to the prediction of the tidal line spectrum is set by the low-frequency continuum, and this limit had been ignored by the tidal community, who had been spoiled by a favorable signal-to-noise ratio. David Cartwright and I made a caustic remark (97) that "noise-free processes do not occur except in the literature on tidal phenomena...".

It always pays to know the ultimate limits set by instruments or by nature. Some of the weaker tidal lines routinely included in the harmonic method turned out to be hopelessly contaminated by the noise continuum and might as well be omitted. From these considerations, Cartwright and I (97) proposed a "Response Method of Tidal Prediction", which consists of using station records to compute the transfer function between the tide-producing forces and the station response. This differs somewhat from the classical harmonic method, which independently evaluates the amplitudes and phases of the principal tidal constituents. In some tests conducted by Zetler *et al.* (1979) the response method comes out slightly ahead of the harmonic method, but here we have improved one of the few geophysical predictions that already works well.

The third and predominant consideration for working on tides came from an instrumental development. Frank Snodgrass had found that a newly developed quartz crystal pressure transducer was superior to the Vibrotron pressure transducer, our mainstay for some years. Starting in 1965, the quartz transducers were incorporated into capsules freely dropped to the seafloor and subsequently recalled by acoustic command from a surface vessel. (The free-fall technique became commonplace in the early 1970s.) Working with Jim Irish and Mark Wimbush we first did some deep-sea drops off California and located the  $M_2$  amphidrome (the point where the tidal component has zero amplitude) in the Northeast Pacific (119, 126)). This was followed by three drops between Australia and Antarctica, spanning the latitudes where the sublunar point travels around the southern oceans at the speed  $\sqrt{gh}$  of free waves (Irish and Snodgrass 1972). A very naive theory predicts a resonant amplification at such latitudes. We didn't believe the theory, but made the measurements anyhow. The result was a rather dull transition from south Australian to Antarctic tides.

We had organized an international SCOR working group on deep-sea tides, and numerous measurements were being made, particularly by Cartwright in the U.K. and by Mofjeld of NOAA, Miami. Snodgrass participated in an international calibration experiment in the Bay of Biscay. The latest IAPSO publication shows 108 pelagic tide stations have by now been occupied by a number of different investigators. The results have been useful as a check on the numerical modeling of tides.

Our last drops were made in 1974 south of Bermuda in 5.5 km of water, as part of the MODE bottom experiment. We discovered unexpected and still unexplained pressure fluctuations at subtidal frequencies that are coherent over

1000 km (143)! With regard to tides, an analysis led by B. Zetler was in splendid agreement with the traditional Atlantic cotidal charts (145). Two independent drops in the same area gave the following  $M_2$  amplitudes and phases:

32.067 cm and 2.5° Greenwich epoch,  
32.074 cm and 2.6° Greenwich epoch.

When it comes to four-figure accuracies, it is no longer oceanography. Further, satellite altimetry looked increasingly promising for future measurements of deep-sea tides. It was time to move on.

### Internal Waves, 1971-1978

In 1958, Owen Phillips proposed from simple dimensional considerations that the distribution of surface elevation variance with wavenumber  $k$  varies as  $k^{-4}$  ( $L^2$  per unit  $k_x$  per unit  $k_y$ ). This "saturation spectrum" has turned out to be a most useful representation of high-frequency surface waves. Could something as simple and as useful be done about internal waves?

Christopher Garrett and I looked at existing evidence and found it consistent with a spectrum that falls off with horizontal wavenumber as  $k^{-2}$  and with vertical wavenumber as  $m^{-2}$ . The original model proposed in 1972 (130) has gone through a series of revisions, which have been referred to as GM75, GM79... to make explicit the built-in obsolescence. The surprising thing has been the degree of universality of the model spectrum. This indicates a saturation as in the case of the Phillips surface wave spectrum. But whereas the Phillips spectrum is white in curvature (and vertical acceleration), the internal wave spectrum is white in shear and isopycnal slope, suggesting a different saturation process. The entire ocean column is never very far from instability, and occasional internal breakers may play an important role in turbulence and fine scale mixing. The essential work remains to be done (163).

### Ocean Acoustics, 1975-

Regardless of the role played by internal waves in ocean microprocesses, there can be no doubt that internal waves are a dominant source of fluctuation in sound speed. Clark and others have recorded time series of acoustic phase and intensity over a 1000 km transmission path between Eleuthera and Bermuda. From these observations one can infer the mean-square phase rate along any one of the multiple paths that connect source and receiver. The result is  $\langle \dot{\phi}^2 \rangle = 1.6 \times 10^{-5} \text{ sec}^{-2}$ . Fred Zachariasen and I have derived the theory for computing this parameter, given only the mean sound speed structure and an internal wave spectrum (148). For GM75, the result is  $\langle \dot{\phi}^2 \rangle = 2.5 \times 10^{-5} \text{ sec}^{-2}$ . This was the beginning of a major effort led by Roger Dashen and Stan Flatté to derive sound transmission statistics, given the spectrum of the variability in sound speed in ocean space and time (158). Since World War II the acoustic and oceanographic communities have gone their separate ways; I think that we have made a contribution towards bridging this gap.

In 1976, Peter Worcester and Frank Snodgrass set two deep moorings, with an acoustic source and receiver on each mooring. Oppositely-directed acoustic transmissions gave



Photo by Don Altman.

1978. Another oceanographic outing.

information about the 25 km of intervening ocean. Variations in the *average* of the two travel times told something of the fluctuations in the temperature structure; *differences* in the travel times (with and against the current component) gave information about the water movements. This is a powerful technique for measuring ocean features on a scale of tens of kilometers, and it whetted our appetite for acoustic monitoring of the intense mesoscale features, with typical dimensions of 100 km.

At a range of 1000 km an ideal acoustic pulse is received as a complex series of subpulses, one along each of a series of multipaths. Our work predicts the effective spread of the subpulses, and hence the time *resolution* between separate

paths. It also predicts the decorrelation time of the pulse structure, and hence the interval at which independent samples are taken. Typical values are 50 ms and 5 minutes. On this basis, Carl Wunsch and I have estimated that we can measure week-to-week fluctuations in acoustic travel time along a fixed path to an accuracy of 20 ms. But the expected variations from mesoscale ocean eddies are many times this large. Accordingly, we have proposed to measure the variable travel times between a series of moored acoustic sources each transmitting to a series of acoustic receivers, and then to construct three-dimensional charts of sound speed (essentially temperature) by an appropriate inverse theory (157). The idea is very simple; in the case of a warm eddy (say) all

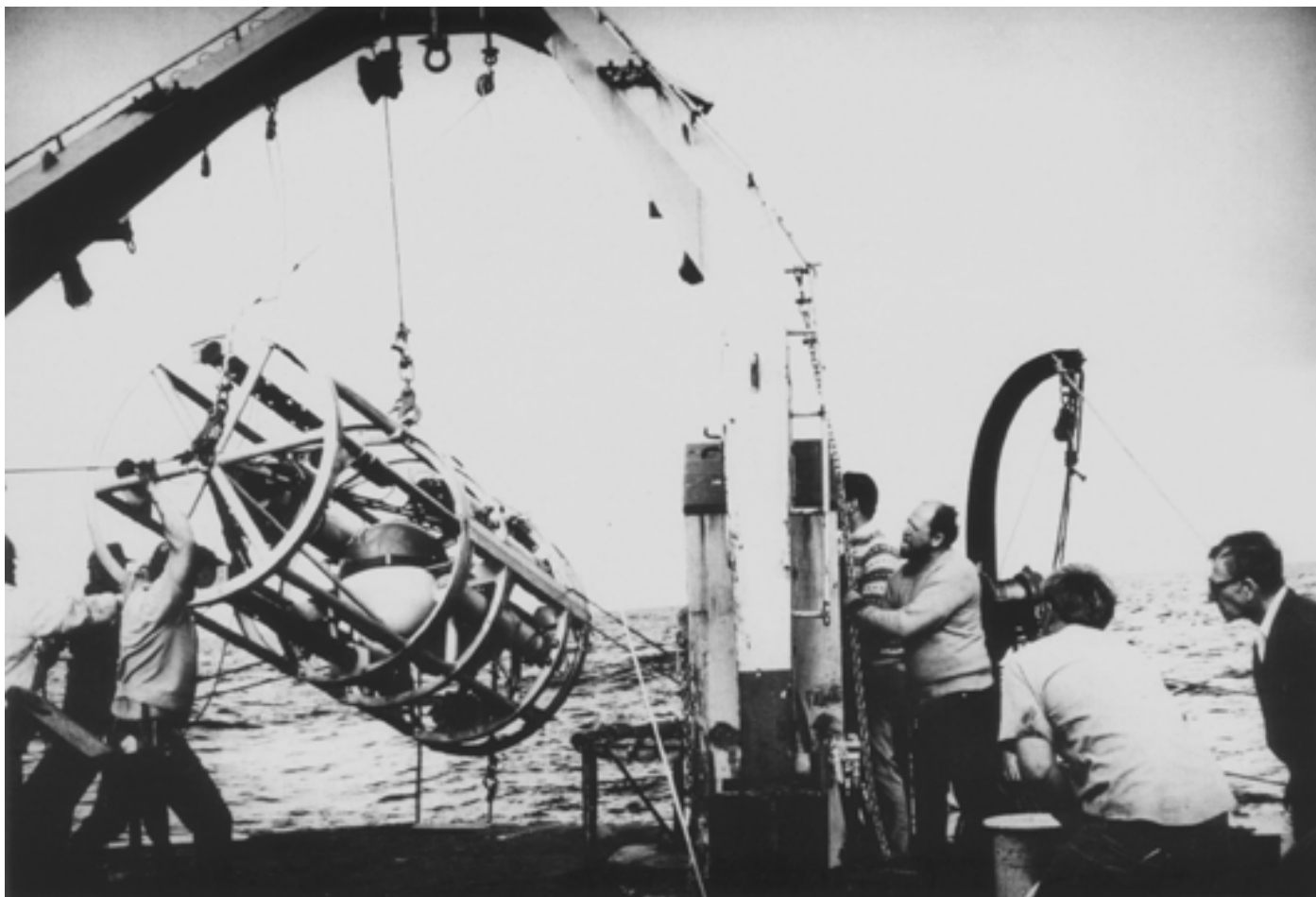

Photo by Don Altman.

1978. Aboard the R/V THOMAS WASHINGTON in an early experiment leading to Ocean Acoustic Tomography.

those rays that pass through the eddy will come in early by something like a quarter second, whereas the other transmissions are not affected. If the eddy is shallow, then only the early steep paths are affected; if it is deep, then the late flat paths (near the sound axis) are affected as well.

We have formed a joint venture involving Robert Spindel of Woods Hole, Carl Wunsch of MIT, Theodore Birdsall of Michigan, and our group at Scripps. In November, 1977, Spindel put out a 2000-m deep mooring south of Bermuda, which our graduate student, John Spiesberger, monitored at a coastal station 1000 km distant. There are about a dozen distinct arrivals, and those can be clearly traced over the two-month transmission period. The key questions were: (i) whether the multipath arrivals could be resolved, (ii) whether they could be identified with constructed rays connecting source and receiver, and (iii) whether such paths are sufficiently stable for inverse monitoring. Spiesberger found the answer "yes" to each of the questions.

In 1981, we established a 300 km $\times$ 300 km array southwest of Bermuda (the Bermuda square) consisting of four sources and five receivers. There are then 20 source-receiver pairs providing information along each of 20 sections. One of the beauties of tomography is that you gain information

geometrically with the *product* of the number of source-times-receiver moorings, rather than with the *sum* of moorings as in traditional oceanographic spot measurements. (In the 1981 experiment we learned painfully that the array can also deteriorate geometrically, as was the case because of an early battery failure.) The experiment produced a great deal of data, and the preliminary inversions demonstrated a westward migration of an eddy through the array in agreement with CTD surveys conducted by David Behringer (171). As this is being written, Carl Wunsch and his student, Bruce Cornuelle, are continuing their work on inverting the acoustic data with continued improvements. The definitive reductions will take yet another year.

Our long term goal is to measure the variability of ocean gyres by using acoustic transmission over one or two megameters. Henry Stommel and Larry Armi have found some evidence for a gyre wobble. The unique advantage of the acoustic method is that it yields immediately the required long-range averages, instead of depending on the sums of local measurements. We ought to be able to measure changes in the mean temperature by a few millidegrees per year, and this might *now* be taking place (though I doubt it) because of the injection of CO<sub>2</sub> into the atmosphere. "Reciprocal tomography" should yield mean currents to a precision of about

1 mm/s, and this offers the opportunity to use a "sing-around" in a triangular array to check the vorticity balance of the gyre circulation, an old dream that goes back to the 1950's. A crucial question has to do with the vertical resolution of the inverse method.

During our 1982 sabbatical in Cambridge, England, Carl Wunsch and I gave our imagination free rein in what might ultimately be done in a combined system of satellite altimetry and scatterometry (measuring surface stress), acoustic tomography and numerical modeling (172).

So much for the main topics that have kept me busy. Nearly all the work has been done in collaboration with others; the bibliography at the end of the chapter is a way to make explicit my indebtedness to so many people. My principal collaborators have been Roger Revelle, Charles Cox, George Carrier, Klaus Hasselmann, Gordon MacDonald, David Cartwright, Bernard Zetler, Chris Garrett, Fred

Zachariasen and Carl Wunsch. My partnership with Frank Snodgrass lasted through 23 happy and constructive years. He retired in 1976 to become a farmer in Oregon, and I have never quite recovered from this loss.

I have two or three graduate students at a time (the most I can manage), and work closely with them. Among them are Gordon Groves, Earl Gossard, Charles Cox, June Pattullo, Mohammed Hassan, Gaylord Miller, Mark Wimbush, Jim Irish, Jim Cairns, Gordon Williams, Peter Worcester, John Spiesberger, Mike Brown, and now Bruce Howe. I have learned more from them than they have learned from me.

Among my teachers are three men in particular: Harald Sverdrup (a Norwegian) taught me how to write English, and how to treat each observation with great care and respect (so much of this is lost in computer analyses and plots). Roger Revelle introduced me to the romance of work at sea, and showed me his style of broad-range inquiry. Carl Eckart taught me some classical physics. I have always regretted that



1952. Williard Bascom took this picture in Bikini Lagoon when I was about to be devoured by a shark! I was standing on the bottom with a tsunami pressure gauge which I had raised above my head and was holding there to obtain a Laplace transform of instrument response, when I noticed Bascom taking a most unusual photographic interest in this operation. I puzzled about this for some minutes, and then had a sudden revelation that made me turn around. The calibration was an incomplete step function.

I did not learn more physics before becoming absorbed in oceanography. I also regret that I am so poor at building and repairing gear (I was sheltered from this as a boy).

In 1958, we started a branch of the University-wide Institute of Geophysics (later Geophysics and Planetary Physics) on the Scripps campus. Roger Revelle and Louis Slichter made this possible. My wife, Judith, chose the laboratory site and the multi-level, one-story redwood construction. At the time, I was working on solid-earth geophysics, and this is reflected by the early appointments. I became rather lonely when my interest returned to the sea. We are now fairly evenly divided, and for many years we split the job with Freeman Gilbert looking after solid-earth geophysics. In 1982, I stepped down as Associate Director after being in the job for 24 years. Freeman Gilbert was willing to take over, and the Institute is in very good shape. The birth and coming-of-age of IGPP has been one of my most rewarding experiences.

This biographical sketch would be unbalanced without some comments on an association with the United States Navy which spans my entire career (except for an interlude in World War II when my security clearance was suddenly withdrawn). The Office of Naval Research has given our work generous and effective support ever since ONR was formed, not only with money but in other ways as well. I owe a deep gratitude to this remarkable organization. At the same time I have been able to serve the Navy in different ways. In 1946, Bill Von Arx and I surveyed the circulation of Bikini lagoon and assessed its flushing rate prior to an underwater nuclear explosion. In 1951, working with Roger Revelle, John Isaacs, Willard Bascom, and Norman Holter, we monitored at close range the oceanographic effects of a very large thermonuclear explosion. And in recent years, largely through my association with JASON, I have been involved in a diverse set of Navy problems.



1952. Looking at a giant coral during OPERATION CAPRICORN. This is my favorite picture.



Photo courtesy of Archives of The Scripps Institution of Oceanography, University of California, San Diego.

Scientists on the homeward bound *Baird*. Left to right, back row: Dick Van Herzen, Roger Revelle, Willard Bascom, Ted Folsom, Alan Jones, Gustaf Arrhenius, Henri Rotschi, Robert Livingston, Russell Raitt. Seated: Phil Jackson, Dick Blumberg, Ronald Mason, Bob Dill, Art Maxwell, Winter Horton, Walter Munk, and Helen Raitt.

February 1953. *CAPRICORN* homeward bound. We had left six months earlier, first participating in an atomic experiment in the Marshall Islands. Win Horton is sitting on my right; I later married his sister.

The 1951 nuclear test IVY-MIKE almost brought my scientific career to an end. Revelle, Isaacs, and I had expressed to high AEC authority our fear that the thermonuclear shock to which Eniwetok Atoll was to be subjected might trigger a submarine landslide.\* This, in turn, could generate a tsunami of destructive dimensions over much of the Pacific. Accordingly, quiet plans were made for a possible evacuation of many low-lying areas all over the Pacific. Scripps moored two small rafts to a nearby seamount 36 miles from ground zero, with wave instruments attached to each mooring. I was aboard one of the rafts. The Scripps vessel *Horizon* stood within sight of both rafts. Observers on the rafts were to signal any suspicious event to the *Horizon*,

which maintained open contact to the flagship *Mt. McKinley*, so that signals could flow instantly to Navy personnel standing by at the evacuation sites.

I should stress that the probability for a destructive wave was very, very small, and in fact nothing happened. After witnessing the explosion at this close range, and seeing no wave signal for 11 minutes thereafter (the computed time was 6 minutes following the landslide), we transferred to the *Horizon* and steamed north at full speed to avoid radioactive fallout (unsuccessfully as it turned out). We returned in two days to pick up the rafts and instrumentation. I unspooled the record, checking the time marks made prior to my leaving the raft. Within 90 seconds following the final time mark was a record signature equivalent to a huge tidal wave. (I do not know what went wrong.) It is true the "event" occurred too late to be consistent with computations, but I rather think

\*There are very few earthquakes in this area of the Pacific.



1963. *Ida and Cecil Green present IGPP with "Spring Stirring", a large diorite by Donal Hord. The sculptor is to the left.*

that under the existing stress (and having in mind the possibility of a delayed landslide), I would have given the signal, and thus set into motion the evacuation of thousands of people from hundreds of sites. Under the circumstances, I would have been too embarrassed to return to Scripps and would have left the ship at the next landfall, Tongatapu.

I came home and married Judith Horton (my second marriage). Judy has been a willing confidante in all subsequent affairs of the sea, often an instigator. She took the 04<sup>h</sup> to 08<sup>h</sup> watch in recording southern swell rolling onto the beach at our *fale* in Tutuila; she navigated our Landrover through a sea of Ukranian mud on our way to the oceanographic station at Gelendsik; and she helped celebrate Austrian Independence Day at Schönbrunn. Judy was responsible for taking the plunge of starting the Geophysics Institute at La Jolla, and then saw to it that it was elegantly housed on the Scripps cliff.

Judy's great grandfather came to San Diego to practice medicine. As a young girl she was a disciple of San Diego sculptor Donal Hord, and she does life-sized figures in terra cotta. She studied architectural design with Richard Nentra at Bennington, and was admitted to Harvard Graduate School of Design. I walk to work from SEICHE, which has been a continuing project for both of us for thirty years (I am the resident plumber and electrician).

We have two daughters, Edie and Kendall; our oldest daughter Lucian was born with a defective heart and died at the age of five. Neither of our daughters are scientists (though my younger daughter married a chemist), nor did I make any effort to steer them in that direction. The girls have minds of their own; but I take pride that they are also good skiers.





1962. Judith and I on our first trip to the USSR. We had shipped our Land Rover to Helsinki, and entered the Soviet Union at the Finnish border. A month later we left Russia at Odessa. The Cuban Missile Crisis occurred while we were driving south.

We have taken advantage of an oceanographer's opportunity to travel. Judy and I have been to Russia three times, the first time during the Cuban missile crisis. We took part in establishing a bond between American and Soviet oceanographers following World War II, and I regret that this bond has now weakened. I have been to the Peoples Republic of China twice in the last five years, the second time as chairman of the first U.S. oceanographic delegation (159a). I was asked "Was it your father who worked on ocean waves?"; or "Did you have a relative with a name similar to yours who worked on tides?", etc. When I replied that they must be referring to my own early work, the response was: "But you are working in acoustics!". Evidently a Chinese oceanographer whose thesis is on tsunamis still works on tsunamis when he retires. The succession of promiscuous affairs that have characterized my career (and which I chose for a title of this biographical sketch) is alien to the Chinese culture.



April 1968. Visiting Soviet Armenia. Oceanographer R.V. Ozmidov is to the right.



We have lived in Venice, where I worked on the *aqua alta* problem. But Judy soon turned our attention to a project with John Asmus for cleaning statues with laser pulses, and for preparing holograms for three-dimensional viewing of Renaissance figures. (We wrote a joint sculpture-oceanography paper (131)). We go to Venice, to Südtirol and to Austria whenever there is an opportunity; we still have my grandfather's land on a lake near Salzburg.

We love Cambridge, England, and have been there for three sabbaticals, two in residence at Churchill College. (My mother read Botany at Newnham College in 1912; her tutor was Harold Jeffreys.) We spent six months at the other Cambridge in 1967. Judy had been awarded a coveted Radcliffe Institute Fellowship which gives women a chance to resume their careers after a family interruption. (Frank Press arranged a MIT visiting professorship for me.) Judy's plan

*August 1981. Venice. Since learning to paddle a Plättel in Altanssee Lake, in Austria as a boy, I had been hoping for an opportunity to be my own gondolier. In Venice Judy and I worked together on applying laser pulses to clean statues.*



*October 1978. At the Institute of Marine Instrumentation, Tianjin, Peoples Republic of China. Sung Wen, Director, is to the right of me. Other members of the U.S. delegation on this photograph are D. Inman, J. Edmond, and C. Wunsch (from left to right in the first row). Between the Director and me, in the back row, is Xu Yukun, who came to visit our Institute in 1981-83.*

was to work at the Harvard School of Design, where she had been a student when she came down with polio at the age of twenty-one (she has had to walk on crutches ever since). We went to Robinson Hall where Judy had been assigned a drafting table. We were taken to the basement and then to a desk; it turned out to be the very same desk that had been Judy's when she was a student there twenty years earlier. "It looks just the same," Judy said, "and as far as I can tell the place hasn't been swept since."

Roger Revelle's theme in talking to students is that "you have to be lucky." He is so right. And my luck crested in October 1982 when so many of our friends with whom I had worked and lived came to La Jolla and helped celebrate my birthday.

#### Literature Cited

- Bascom, W. 1961. *A Hole in the Bottom of the Sea*. Doubleday, 352 pp.
- Crombie, D.D. 1955. Doppler spectrum of sea echo at 13.56 Mc/s. *Nature*, **175**, 681.
- Hughes, B., H.L. Grant and R.W. Chappell. 1977. A fast response surface wave slope meter and measured wind wave moments. *Deep-Sea Res.*, **24**, 1211.
- Irish, J.D. and F.E. Snodgrass. 1972. Australian-Antarctic tides. *Am. Geophys. Union Antarctic Res. Ser.*, **19**, 101.
- Lambeck, K. 1980. *The Earth's Variable Rotation: Geophysical Causes and Consequences*. Cambridge University Press.
- Mognard, N.M., W.J. Campbell, R.E. Cheney, J.G. Marsh and D.B. Ross. 1982. Southern ocean waves and winds derived from Seasat altimeter measurements. *Wave Dynamics and Radio Probing of the Ocean Surface*. Plenum Press.
- Solow, H. 1963. How NSF got lost in Mohole. *Fortune*, May 1963, 138.
- Stommel, H. 1948. The westward intensification of wind-driven ocean currents. *Trans. Amer. Geophys. Union*, **29**, 202.
- Sverdrup, H.U. 1947. Wind-driven currents in a baroclinic ocean; with application to the equatorial currents of the eastern Pacific. *Proc. Nat. Acad. Sci.*, **33**, 318.
- Teague, C.C., G.L. Tyler and R.H. Stewart. 1977. Studies of the sea using HF radio scatter. *IEEE Trans. Antennas Propagat.*, **AP-25**, 12.
- Zetler, B., D. Cartwright and S. Berkman. 1979. Some comparisons of response and harmonic tide predictions. *Int. Hydrogr. Rev., Monaco LVI (2)*, 105.



1981. On sabbatical, our second at Churchill College and our third at Cambridge University.



Photo by Roy Porello

October 19, 1982. Celebrating the 65th.

# BIOGRAPHY

Walter H. Munk

**Date of birth:** October 19, 1917 (Vienna, Austria)

**Education:** B.S., California Institute of Technology (1939)  
M.S., California Institute of Technology (1940)  
Ph.D., University of California (1947)

**Memberships, Honors and Awards:**

Member, National Academy of Sciences (Chairman, Geophysics Section, 1975-78)  
Member, American Philosophical Society  
Foreign Member, The Royal Society, London  
Member, Deutsche Akademie der Naturforscher Leopoldina  
Member, American Academy of Arts and Sciences  
Member, American Geological Society  
Fellow, American Geophysical Union  
Fellow, American Association for the Advancement of Science  
Fellow, American Meteorological Society  
Fellow, Acoustical Society of America  
Guggenheim Fellow, Oslo University (1948); Cambridge (1955 and 1962)  
Overseas Fellow, Churchill College (1962 and 1981-82)  
Fulbright Fellow, U.K. (1981-82)  
Senior Queen's Fellow, Australia (1978)  
Arthur L. Day Medal, American Geological Society (1965)  
Sverdrup Gold Medal, American Meteorological Society (1966)  
Alumni Distinguished Service Award, California Institute of Technology (1966)  
Gold Medal of the Royal Astronomical Society (1968)  
California Scientist of the Year, California Museum of Sciences and Industry (1969)  
Josiah Willard Gibbs Lecturer, American Mathematical Society (1970)  
Doctor Philosophiae Honoris Causa, University of Bergen, Norway (1975)  
Maurice Ewing Medal, American Geophysical Union and U.S. Navy (1976)  
Agassiz Medal, National Academy of Sciences (1976)  
Professional Achievement Award, UCLA Alumni Association (1977)  
UCSD Alumnus of the Year (1978)  
The Captain Robert Dexter Conrad Award, Department of the Navy (1978)

**Positions:**

Assistant Professor of Geophysics (1947-49), Associate Professor of Geophysics (1949-54), Professor of Geophysics (1954-present), Scripps Institution of Oceanography, University of California, San Diego  
Associate Director, Institute of Geophysics and Planetary Physics, University of California, San Diego (1959-1982)

# BIBLIOGRAPHY

Walter H. Munk\*

1941

- 1 Internal waves in the Gulf of California. *J. Mar. Res.*, 4(1):81-91.

1946

- 2 H.U. Sverdrup and W.H. Munk. Empirical and theoretical relations between wind, sea and swell. *Trans. Am. Geophys. Union*, 27(6):823-27.
- 3 H.U. Sverdrup and W.H. Munk. Theoretical and empirical relations in forecasting breakers and surf. *Trans. Am. Geophys. Union*, 27(6):828-36.

1947

- 4 W.H. Munk and M.A. Traylor. Refraction of ocean waves: a process linking underwater topography to beach erosion. *J. Geol.*, 55(1):1-26.
- 5 Tracking storms by forerunners of swell. *J. Meteorol.*, 4(2):45-57.
- 6 Increase in the period of waves traveling over large distances; with application to tsunamis, swell, and seismic surface waves. *Trans. Am. Geophys. Union*, 28(2):198-217.
- 7 H.U. Sverdrup and W.H. Munk. Wind, sea, and swell: theory of relations for forecasting. U.S. Hydrographic Office Tech. Rpt. No. 1, H.O. Publ. 601:1-44.
- 8 Effect of Earth's rotation upon convection cells. *Ann. N.Y. Acad. Sci.*, 48(8):815-20.
- 9 A critical wind speed for air sea boundary processes. *J. Mar. Res.*, 6(3):203-218.

1948

- 10 Wave action on structures. *Petrol. Technol.*, 11(2) Art. TP 2322:1-18.
- 11 W.H. Munk, H. Iglesias and T. Folsom. An instrument for recording ultra-low-frequency ocean waves. *Rev. Sci. Instrum.*, 19(10):654-658.
- 12 W.H. Munk and M. Sargent. Adjustment of Bikini Atoll to ocean waves. *Trans. Am. Geophys. Union*, 29(6):855-60.
- 14 W.H. Munk and E.R. Anderson. Notes on a theory of the thermocline. *J. Mar. Res.*, Sverdrup Anniv. Vol. 7(3):276-295.
- 18 R. Revelle and W. Munk. Harald Ulrik Sverdrup — an appreciation. *J. Mar. Res.*, Sverdrup Anniv. Vol. 7(3):127-31.

1949

- 13 W.H. Munk, G.C. Ewing and R.R. Revelle. Diffusion in Bikini Lagoon. *Trans. Am. Geophys. Union*, 30(1):59-66.
- 15 Note on period increase of waves. *Bull. Seism. Soc. Am.*, 39(1):41-45.
- 16 The solitary wave theory and its application to surf problems. *Ann. N.Y. Acad. Sci.*, 51(3):376-424.
- 17 J.A. Putnam, W.H. Munk and M.A. Traylor. The prediction of longshore currents. *Trans. Am. Geophys. Union*, 30(3):337-45.
- 19 Surf beats. *Trans. Am. Geophys. Union*, 30(6):849-54.

1950

- 20 On the wind-driven ocean circulation. *J. Meteorol.*, 7(2):79-93.
- 21 W.H. Munk and R.L. Miller. Variations in the Earth's angular velocity resulting from fluctuations in atmospheric and oceanic circulation. *Tellus*, 2(2):93-101.
- 22 W.H. Munk and G.F. Carrier. The wind-driven circulation in ocean basins of various shapes. *Tellus*, 2(3):158-67.
- 23 W.H. Munk, G.W. Groves and G.F. Carrier. Note on the dynamics of the Gulf Stream. *J. Mar. Res.*, 9(3):218-38.
- 25 Oceanography, ocean currents, waves. *Collier's Encyclopedia*:100-04, 170-71, 398.

1951

- 24 W. Munk and E. Palmén. Notes on the dynamics of the Antarctic circumpolar current. *Tellus*, 3(1):53-55.
- 27 Y. Mintz and W. Munk. The effect of winds and tides on the length of day. *Tellus*, 3(3):117-21.
- 28 W.H. Munk and R.S. Arthur. Forecasting ocean waves. *Compendium of Meteorol.*, *Am. Meteorol. Soc.*:1082-89.
- 29 Ocean waves as a meteorological tool. *Compendium of Meteorol.*, *Am. Meteorol. Soc.*:1090-1100.

1952

- 26 Origin and generation of waves. In: *Proc. First Conference Coastal Eng.*, 1-4 Oct. 1950, Long Beach. Reprinted U.S.N. Civ. Eng. Corps Bull., 6(5):133-36.
- 30 W. Munk and R. Revelle. Sea level and the rotation of the Earth. *Am. J. Sci.*, 250:829-33.
- 31 W. Munk and G. Riley. The absorption of nutrients by aquatic plants. *J. Mar. Res.*, 11(2):215-40.
- 32 R.S. Arthur, W.H. Munk and J.D. Isaacs. The direct construction of wave rays. *Trans. Am. Geophys. Union*, 33(6):855-65.
- 33 W. Munk and R. Revelle. On the geophysical interpretation of irregularities in the rotation of the Earth. *Mon. Not. R. Astron. Soc., Geophys. Suppl.*, 6(6):331-47.

\*The papers are organized according to the year of publication; numbers are generally in order of acceptance for publication, and therefore not sequential. An exception is #169 which was written in 1952 but remained classified until 1981. Paper 115 (written in 1969) is still classified. Some informal contributions are numbered according to the preceding publication followed by a, b, ... (e.g. 129a, 129b in 1971).

- 34 W. Munk and G. Groves. The effect of winds and ocean currents on the annual variation in latitude. *J. Meteorol.*, 9(6):385-96.
- 35 W.H. Munk and R.S. Arthur. Wave intensity along a refracted ray. Natl. Bureau Standards Circular, Gravity Waves, 521:95-108.
- 37 G.F. Carrier and W.H. Munk. On the diffusion of tides into permeable rock. In: *Wave Motion and Vibration Theory, Proc., Symp. in Appl. Math.*, 169 pp., 5:89-96, McGraw Hill.
- 39 The roughness of the air-sea boundary. Geophys. Res. Pap. No. 19, Internatl. Symp. on Atmospheric Turbulence in the Boundary Layer, MIT, 4-8 Jun. 1951, Geophys. Res. Directorate, AF Cambridge Res. Ctr. Tech. Rpt. 53-9: 141-44.
- 41 Air-sea boundary processes. Oceanographic Instrumentation, Natl. Acad. Sci., Natl. Res. Council, Publ. 309:159-61, 210-13.
- 169 W. Bascom, W. Munk and W. Van Dorn. Barometric and water-surface waves produced by Mike Shot. Operation IVY, Joint Task Force 132, WT-635, 1952 (declassified 1981).
- 1953
- 36 Small tsunami waves reaching California from Japanese earthquake of 4 March 1952. *Bull. Seism. Soc.*, 43(3):219-22.
- 1954
- 12b W.H. Munk and M.C. Sargent. Adjustment of Bikini Atoll to ocean waves. Geol. Survey Professional Pap. 260C:275-80.
- 38 E. Gossard and W. Munk. On gravity waves in the atmosphere. *J. Meteorol.*, 11(4):259-69.
- 40 The delayed hot-water problem. *J. Appl. Mech.*, 21(2):193.
- 42 Y. Mintz and W. Munk. The effect of winds and bodily tides on the annual variation in the length of day. *Mon. Not. R. Astron. Soc., Geophys. Suppl.*, 6(9):566-78.
- 43 C. Cox and W. Munk. Measurement of the roughness of the sea surface from photographs of the Sun's glitter. *J. Opt. Soc. Am.*, 44(11):838-50.
- 44 C. Cox and W. Munk. Statistics of the sea surface derived from sun glitter. *J. Mar. Res.*, 13(2):198-227.
- 1955
- 45 C. Cox and W. Munk. Some problems in optical oceanography. *J. Mar. Res.*, 14(1):63-78.
- 46 The circulation of the oceans. *Sci. Am.*, 193(3):96-104.
- 47 Wind stress on water: a hypothesis. *Q. J. Roy. Meteorol. Soc.*, 81(349):320-32.
- 48 J. Pattullo, W. Munk, R. Revelle, E. Strong. The seasonal oscillation in sea level. *J. Mar. Res.*, 14(1):88-155.
- 49 R. Revelle and W. Munk. Evidence from the rotation of the Earth. UGGI Bull., Extrait des Annales de Geophysique, 11(1):104-8.
- 50 E. Gossard and W. Munk. Gravity waves in the atmosphere: correspondence. *Q. J. Roy. Meteorol. Soc.*, 81(349): 484-87.
- 53 High-frequency spectrum of ocean waves. WHOI Convocation, *J. Mar. Res.*, 14(4):302-14.
- 1956
- 48a Geophysical discussion. *Roy. Astron. Soc.*, reprinted from *The Observatory*, 76:56-57.
- 51 W. Munk, F. Snodgrass and G. Carrier. Edge waves on the continental shelf. *Science*, 123(3187):127-32.
- 52 Polar wandering: a marathon of errors. *Nature*, 177:551-54.
- 54 C. Cox and W. Munk. Slopes of the sea surface deduced from photographs of sun glitter. Scripps Institution of Oceanography Bull., 6(9):401-88.
- 1957
- 55 Waves of the Sea. *Encyclopedia Britannica*.
- 56 Comments on review by C. L. Bretschneider. *Trans. Am. Geophys. Union*, 38(5):778-81.
- 57 W.H. Munk and F.E. Snodgrass. Measurements of southern swell at Guadalupe Island. *Deep-Sea Res.*, 4:272-86.
- 59 W.H. Munk, M.J. Tucker and F.E. Snodgrass. Remarks on the ocean wave spectrum. In: Symposium on Naval Hydrodynamics, Publ. No. 515, Chptr. 3:45-60.
- 65a Harald Ulrik Sverdrup, in memoriam. *Deep-Sea Res.*, 4(4):289-90.
- 1958
- 58 F. Snodgrass, W. Munk and M.J. Tucker. Offshore recording of low-frequency ocean waves. *Trans. Am. Geophys. Union*, 39(1):114-20.
- 60 W. Elsasser and W. Munk. Geomagnetic drift and the rotation of the Earth. Gutenberg Volume, "Contributions in Geophysics: In Honor of Beno Gutenberg," *Deep-Sea Res.*, 17:228-36.
- 61 The seasonal budget of water. In: *Geophysics and the I.G.Y., National Academy Symposium*, ed. H. Odishaw et al., Geophys. Monogr. No. 2, pp. 175-76. Wash., D.C.:Am. Geophys. Union.
- 62 W. Munk and R. Haubrich. The annual pole tide. *Nature*, 182:42.
- 63 Waves of the sea. *The Book of Popular Science*, pp. 361-68.
- 64 Remarks concerning the present position of the pole. *Geophysica*, 6(3-4):335-55.
- 71 G.W. Groves and W.H. Munk. A note on tidal friction. *J. Mar. Res.*, Tommy Thompson Vol. 17:199-214.
- 1959
- 65 B. Haurwitz, H. Stommel, W. Munk. On the thermal unrest in the ocean. In: *The Rossby Memorial Volume*, pp. 74-94, New York: The Rockefeller Institute Press.
- 66 H. Benioff, J.C. Harrison, L. LaCoste, W.H. Munk, and L.B. Slichter. Searching for the Earth's free oscillations. *J. Geophys. Res.*, 64(9):1334-37.
- 67 W.H. Munk, F.E. Snodgrass and M.J. Tucker. Spectra of low-frequency ocean waves. Scripps Institution of Oceanography Bull., 7:283-362.
- 68 R. Haubrich and W. Munk. The pole tide. *J. Geophys. Res.*, 64(12):2373-88.

1960

- 69 Smoothing and persistence. *J. Meteorol.*, 17(1):92-93.  
 70 W.H. Munk and G.J.F. MacDonald. Continentality and the gravitational field of the Earth. *J. Geophys. Res.*, 65(7):2169-72.  
 72 W. Munk and G.J.F. MacDonald. *The Rotation of the Earth: A Geophysical Discussion*. Cambridge University Press, 323 pp.

1961

- 73 W.H. Munk and E.M. Hassan. Atmospheric Excitation of the Earth's wobble. *Geophys. J. R. Astron. Soc.*, Jeffreys Jubilee Vol. 4:339-58.  
 74 J. Miles and W. Munk. Harbor paradox. In: *Proc. Am. Soc. Civ. Eng., J. Waterways and Harbors Div.*, 87(WW3):111-30.  
 75 W. Munk and H. Cepeda. Concerning a remarkably sharp peak in the sea level spectrum at Acapulco. *Geophysica Internatl.*, 1(3):45-54.

1962

- 76 D.L. Inman, W.H. Munk and M.A. Balay. Spectra of low-frequency ocean waves along the Argentine shelf. *Deep-Sea Res.*, 8:155-64.  
 77 Introduction to *The Tides*, by George Howard Darwin, pp. ix-xv, San Francisco:H. Freeman and Company.  
 78 F.E. Snodgrass, W.H. Munk and G.R. Miller. Long-period waves over California's continental borderland. Part I. Background spectra. *J. Mar. Res.*, 20(1):3-30.  
 79 G.R. Miller, W.H. Munk, and F.E. Snodgrass. Long-period waves over California's continental borderland. Part II. Tsunamis. *J. Mar. Res.*, 20(1):31-41.  
 80 W.H. Munk, G.R. Miller, and F.E. Snodgrass. Long-period waves over California's continental borderland. Part III. The decay of tsunamis and the dissipation of tidal energy. *J. Mar. Res.*, 20(2):119-20.  
 81 Long ocean waves. In: *The Sea*, ed. M. N. Hill, Vol. 1, Sect. 5, Chapt. 18, pp. 647-63, London:Interscience.  
 108 W. Munk, R. Haubrich and G. Backus. Array studies of background noise. In: *Proc. of the Colloquium on Detection of Underground Nuclear Explosions, Acoustic and Seismic Lab.*, Inst. of Sci. and Tech., Univ. of Michigan, Ann Arbor, Aug. 1962:95-124.

1963

- 82 R.A. Haubrich, W.H. Munk, F.E. Snodgrass. Comparative spectra of microseisms and swell. *Bull. Seism. Soc. Am.*, 53(1):27-37.  
 83 K. Hasselmann, W. Munk, and G.J.F. MacDonald. Bispectra of ocean waves. In: *Time Series Analysis*, ed. M. Rosenblatt, Chapt. 8, pp. 125-39, John Wiley and Sons.  
 84 W.H. Munk, Moderator. Panel discussion, "Ocean Wave Spectra." In: *Proc. of Conf., 1-4 May 1961, Easton, Md.*, pp. 333-45, Prentice-Hall: arranged by NAS.  
 85 W.H. Munk, G.R. Miller, F.E. Snodgrass, N.F. Barber. Directional recording of swell from distant storms. *Philos. Trans. R. Soc. London*, Ser. A, No. 1062, 255:505-84.  
 86 W.H. Munk and E.C. Bullard. Patching the long-wave spectrum across the tides. *J. Geophys. Res.*, 68(12):3627-34.

- 87 Some comments regarding diffusion and absorption of tsunamis. In: *Proc. Tsunamis Meetings*, 10th Pacific Science Congress, Honolulu, 1961, IUGG:53-72.

1964

- 88 W.H. Munk and D. Davies. The relationship between core accretion and the rotation of the Earth. In: *Isotopic and Cosmic Chemistry*, ed. H. Craig et al., Urey Volume, pp. 341-46, Amsterdam:North Holland.  
 89 W. Munk, F. Snodgrass, and F. Gilbert. Long waves on the continental shelf: an experiment to separate trapped and leaky modes. *J. Fluid Mech.*, 20(4):529-54.  
 90 W. Munk and K. Hasselmann. Super-resolution of tides. In: *Studies on Oceanography*, ed. K. Yoshida, Hidaka Volume, pp. 339-44, Toyko. Reprinted Univ. of Wash. Press, 1965.  
 91 E.C. Bullard, F.E. Oglebay, W.H. Munk, and G.R. Miller. A user's guide to BOMM. A system of programs for the analysis of time series. Institute of Geophysics and Planetary Physics, University of California, La Jolla, California, 108 pp.  
 91a W.H. Munk and G.J.F. MacDonald. Third presentation of the James B. Macelwane Award, April 12, 1964: citation (awarded to Klaus Hasselmann). *Trans. Am. Geophys. Union*, 45(2):289-90.

1965

- 92 W.H. Munk, B. Zetler and G.W. Groves. Tidal Cusps. *Geophys. J.*, 10:211-19.  
 92a Waves across the Pacific. An expedition to study how waves lose their energy. *Oceanus*, 11(3):8-12.  
 93 Tides of the Planet Earth. In: *AFOSR 10th Anniversary Summer Scientific Seminar*, Cloudcroft, N. M.,:134-37.  
 95 Acceptance of the Day Award. Geol. Soc. Am. Annual Meeting, Nov., 1965, Kansas City, Mo., *Bull. Geol. Soc. Am.*, 76(12):233-35.

1966

- 94 Coupling of waves, tides and the climatic fluctuation of sea level. In: *Advances in Earth Science*, ed. P. M. Hurley, pp. 185-95, Boston:MIT Press.  
 94a The Nth campus problem. *Bear Facts*, Vol. 4, No. 8, Iss. 38.  
 96 F.E. Snodgrass, G.W. Groves, K.F. Hasselmann, G.R. Miller, W.H. Munk and W.H. Powers. Propagation of ocean swell across the Pacific. *Philos. Trans. R. Soc. London*, Ser. A, No. 1103, 259:431-97.  
 97 W.H. Munk and D.E. Cartwright. Tidal spectroscopy and prediction. *Philos. Trans. R. Soc. London*, Ser. A, No. 1105, 259:533-81.  
 98 Variation of the Earth's rotation in historical times. In: *The Earth-Moon System*, ed. B. G. Marsden et al., pp. 52-59, Plenum Press.  
 98a Donal Hord Eulogy. Private distribution.  
 99 Review of Stommel's Gulf Stream: a physical and dynamical description. *Bull. Am. Meteorol. Soc.*, 47(5):424-25.  
 100 Abyssal recipes. *Deep-Sea Res.*, 13:707-30.  
 102 The abyssal Pacific. Fifth Marchon Lecture, University of Newcastle Upon Tyne, delivered 26 May 1966.

104 Tide Prediction. In: *Proc. from the IBM Scientific Computing Symposium on Environmental Sciences*, 14-16 Nov., Thomas J. Watson Research Center, Yorktown Heights, N.Y.:143-44.

1967

101 R. Radok, W. Munk, and J. Isaacs. A note on mid-ocean internal tides. *Deep-Sea Res.*, 14:121-24.

103 Ocean waves and turbulence. Review of "The Dynamics of the Upper Ocean," by O. M. Phillips. *Nature*, 213:867.

105 J. Houtermans, H.E. Suess and W.H. Munk. Effect of industrial fuel combustion on the carbon-14 level of atmospheric CO<sub>2</sub>. In: *Radioactive Dating and Methods of Low-Level Counting*, Vienna:International Atomic Energy Agency:57-68.

106 W.H. Munk and B.D. Zetler. Deep-sea tides: a program. *Science*, 158:884-86.

107 Some lectures on physical oceanography. In: *Mobil Oil Colloquium Lectures in Pure and Applied Science*, No. 13, 104 pp.

1968

108a W. Munk and R. Revelle. Thirtieth award of the William Bowie Medal, April 8, 1968 (awarded to Roger Revelle). Acceptance and response. *Trans. Am. Geophys. Union*, 49(2):431-34.

109 W. Munk and D. Moore. Is the Cromwell current driven by equatorial Rossby waves? *J. Fluid Mech.*, 33(2):241-59.

110 W. Munk and N. Phillips. Coherence and band structure of inertial motion in the sea. *Rev. Geophysics*, 6(4):447-72.

112 Once again-tidal friction. *Q. J. R. Astron. Soc.*, Harold Jeffreys Lecture:9(4):352:75.

1969

111 W. Munk and M. Wimbush. A rule of thumb for wave breaking over sloping beaches. *Oceanology (USSR)*, Stockmann Memorial Volume 9(1):71-75.

113 Deep-sea tides. In: *Progress in Oceanography*, ed. M. Sears, Vol. 5, pp. 67-69, Pergamon Press.

114 D. Cartwright, W. Munk and B. Zetler. Pelagic tidal measurements: a suggested procedure for analysis. *EOS, Trans. Am. Geophys. Union*, 50(7):472-77.

115 W.H. Munk, C.G. Callan, R. Dashen, J.B. Hartle, J.B. Keller, J. Miles, W.A. Nierenberg, C. Wright, and F. Zachariasen. On some superficial effects from moving sources in a stratified fluid. *J. Defense Research, Series B: Tactical Warfare*:1(2), Classified.

116 W.H. Munk and W.A. Nierenberg. High frequency radar sea return and the Phillips saturation constant. *Nature*, 224(5226):1285.

117 Low frequency tail of the ocean wave spectrum. In: *Sixth Symposium on Naval Hydrodynamics*, 28 Sept. to 4 Oct. 1966, Wash., D.C., ed. R. D. Cooper et al., ONR ACR-136:475-76.

120a Standard wave spectra for open sea structures. In: *Oceanographic Studies*, La Jolla:Bendix Marine Advisors, 6 pp.

1970

119 W. Munk, F. Snodgrass, M. Wimbush. Tides off shore: transition from California coastal to deep-sea waters. *Geophys. Fluid Dyn.*, 1(1)161-235.

120 M. Hendershott and W. Munk. Tides. *Ann. Rev. Fluid Mech.*, 2:205-24.

121 J.B. Keller and W.H. Munk. Internal wave wakes of a body moving in a stratified fluid. *Phys. of Fluids*, 13(6):1425-31.

122 Tides of the deep sea. *Explorers Journal*, 48(3):177-83.

123 B. Zetler, D. Cartwright and W. Munk. Tidal constants derived from response admittances. In: *Sixth International Symposium on Earth Tides*, Strasbourg, Sept. 1969, pp. 175-78.

131b Deep-sea Tides (abstract only). In: *Eighth Symposium Naval Hydrodynamics*, "Hydrodynamics in the Ocean Environment," 24-28 Aug. 1970, Pasadena, ONR-ACR-179:217.

1971

118 M. Wimbush and W. Munk. The benthic boundary layer. In: *The Sea*, ed. A.E. Maxwell, Vol. 4, Pt. 1, Chapt. 19, pp. 731-58, John Wiley and Sons.

124 C.J.R. Garrett and W.H. Munk. The age of the tide and the "Q" of the oceans. *Deep-Sea Res.*, 18:493-503.

125 C.J.R. Garrett and W.H. Munk. Internal wave spectra in the presence of fine-structure. *J. Phys. Oceanogr.*, 1(3):196-202.

125a Tribute to Columbus Iselin. *Oceanus*, Columbus Iselin Iss., 16(2):44.

126 J. Irish, W. Munk and F. Snodgrass. M<sub>2</sub> amphidrome in the Northeast Pacific. *Geophys. Fluid Dyn.*, 2:355-60.

127 B.S. Gallagher and W.H. Munk. Tides in shallow water: spectroscopy. *Tellus*, 23(4-5):346-63.

129 Concluding remarks at the Joint Oceanographic Assembly. In: *Proc. of the Joint Oceanographic Assembly*, 13-25 Sept. 1970, Toyko, ed. M. Uda, pp. 81-83.

129a The benthic boundary (abstract only). In: *Proc. of the Joint Oceanographic Assembly*, 13-25 Sept. 1970, Toyko, ed. M. Uda, p. 138.

129b The circulation near the sea floor (abstract only). In: *Proc. of the Joint Oceanographic Assembly*, 13-24 Sept. 1970, Toyko, ed. M. Uda, p. 230.

1972

128 Turbulence in a stratified ocean. Lecture notes in Physics. In: *Proc. of the Symposium on Statistical Models and Turbulence*, 15-21 July 1971, La Jolla, ed. M. Rosenblatt et al., pp. 455-49.

130 C. Garrett and W. Munk. Space-time scales of internal waves. *Geophys. Fluid Dyn.*, 2:225-64.

131 J. Munk and W. Munk. Venice Hologram. In: *Proc. of the Am. Philos. Soc.*, 116(5):415-42.

131a J.F. Asmus, R.F. Wuerker, and W.H. Munk. Lasers and holography in art preservation and restoration. In: *Proc. of NEREM*, 1-3 Nov. 1972, Boston, pp. 172-75.



- 132 C. Garrett and W. Munk. Oceanic mixing by breaking internal waves. *Deep-Sea Res.*, 19:823-32.
- 134 W.A. Nierenberg and W.H. Munk. Sea spectra and radar scattering. IDA/JASON Note N-817, Contract DAHC15 67 C 011, Log. No. HQ 73-25031, 25 pp.
- 1973
- 133 W.H. Munk and C.J.R. Garrett. Internal wave breaking and microstructure (the chicken and the egg). *Boundary-Layer Meteorol.*, 4:37-45.
- 133a W.H. Munk, J.D. Woods, W.P. Berkemeier, C.G. Little, R.H. Stewart and J. Richter. Working group report II — remote sensing of the ocean. 1972 IUCRM Colloquium, La Jolla. *Boundary-Layer Meteorol.*, 5:201-09.
- 134a W. Brown, W. Munk, F. Snodgrass and B. Zetler. Bottom pressures in the MODE region. *MODE Hot Line News*, 37:1,4.
- 135 Tides. In: *Oceanography — The Last Frontier*, ed. R. C. Vetter, Chapt. 13, pp. 179-87, New York:Basic Books.
- 136 W.H. Munk, F. Snodgrass and B. Zetler. Oceanography from the bottom up. *Naval Res. Rev.*, 26(9):18-24.
- 138 J.F. Asmus, C.G. Murphy and W.H. Munk. Studies on the interaction of laser radiation with art artifacts. In: *Proc. of the SPIE Conference*, 27-29 Aug. 1973, San Diego, Vol. 41, pp.19-27.
- 144 F. Rizzoli and W. Munk. Alcune considerazioni teoriche sul coefficiente di riflessione del sistema parete forata — parete solida. Tr. 61 of Consiglio Nazionale Delle Ricerche, Laboratorio per lo Studio Della Dinamica Delle Grandi Masse, Venezia, Feb., 1973, 23 pp.
- 1974
- 137 Sound channel in an exponentially stratified ocean, with application to SOFAR. *J. Acoust. Soc. Am.*, 55(2):220-26.
- 139 G.L. Tyler, C.C. Teague, R.H. Stewart, A.M. Peterson, W.H. Munk and J.W. Joy. Wave directional spectra from synthetic aperture observations of radio scatter. *Deep-Sea Res.*, 21:989-1016.
- 139a J. Brune and W. Munk. Maurice Ewing Obituary. *Nature*, 252:429.
- 140 M.C. Hendershott, W.H. Munk and B.D. Zetler. Ocean tides from SEASAT-A. In: *SEASAT-A Contributions*, Wash., D.C.:NASA, pp. 54-56.
- 143a Deep sea tides (abstract only). In: *Proc. Int'l Conf., Physics of the Seas*, 13-16 Oct. 1971, Centro Internazionale di Fisica Teorica, Trieste, Quad. No. 206, pp. 103-04.
- 143b Vertical diffusion due to internal wave breaking. In: *Proc. Int'l Conf., Physics of the Seas*, 13-16 Oct. 1971, Centro Internazionale di Fisica Teorica, Trieste, Quad. No. 206, 1 pg.
- 1975
- 141 C. Garrett and W. Munk. Space-time scales of internal waves: a progress report. *J. Geophys. Res.*, 80(3):291-97.
- 142 F. Snodgrass, W. Brown and W. Munk. MODE: IGPP measurements of bottom pressure and temperature. *J. Phys. Oceanogr.*, 5(1):63-74.
- 143 W. Brown, W. Munk, F. Snodgrass, H. Mofjeld and B. Zetler. MODE bottom experiment. *J. Phys. Oceanogr.*, 5(1):75-85.
- 145 B. Zetler, W. Munk, H. Mofjeld, W. Brown and F. Dormer. MODE tides. *J. Phys. Oceanogr.*, 5(3):430-41.
- 146 W.H. Munk, H. Stommel, A.S. Sarkisyan and A.R. Robinson. Where do we go from here? In: *Numerical Models of Ocean Circulation. Proc. of a Symposium*, 17-20 Oct. 1972, Durham, New Hampshire, NAS, Wash., D.C., Chapt. 8, "Conclusions," pp. 349-60.
- 146a SCOR Working Group 27. An intercomparison of open sea tidal pressure sensors. Rpt. of SCOR Working Group 27: "Tides of the Open Sea", Paris, UNESCO Tech. Paps. in Mar. Sci. 21, 67 pp.
- 147 B.D. Zetler and W.H. Munk. The optimum wiggleness of tidal admittances. *J. Mar. Res.*, 33:1-13.
- 147a *The Rotation of the Earth: A Geophysical Discussion*. Cambridge University Press, 323 pp. (2nd printing).
- 1976
- 148 W.H. Munk and F. Zachariasen. Sound propagation through a fluctuating stratified ocean: theory and observation. *J. Acoust. Soc. Am.*, 59(4):818-38.
- 148a W.H. Munk and F. Zachariasen. Reply to "comments on 'sound propagation through a fluctuating stratified ocean: theory and observation'", by J. McCoy, *J. Acoust. Soc. Am.*, 60(5):1217-18.
- 149 F. Dyson, W. Munk and B. Zetler. Interpretation of multipath scintillations Eleuthera to Bermuda in terms of internal waves and tides. *J. Acoust. Soc. Am.*, 59(5):1121-33.
- 149a First presentation Maurice Ewing Medal — acceptance and response. 13 April 1976.
- 149b Award of the Agassiz Medal — acceptance and response. 26 April 1976.
- 150 W.H. Munk and R.W. Preisendorfer. Carl Henry Eckart, 1902-1973. In: *Biographical Memoirs*, NAS, Wash. D.C., Vol. 48, pp. 195-219.
- 1977
- 151 Huge waves can be freaky — so can huge tankers. *L. A. TIMES*, 26 Feb. 1977, Pt. 2:5.
- 151b F.N. Spiess, W.H. Munk, J.D. Isaacs and L.N. Liebermann. Carl Eckart, 1902-1973. In: In Memoriam, University of California, pp. 89-91.
- 151c Graduation at Midland. Unpublished. June, 1977.
- 152 W.H. Munk and G.O. Williams. Acoustic oceanography. *Nature*, 267(5614):774-78.
- 152a Kidd criticized. *LA JOLLA LIGHT*, Letters to the Editor, 11 Aug. 1977.
- 153 R. Revelle and W. Munk. The carbon dioxide cycle and the biosphere. In: *Studies in Geophysics, Energy and Climate*, Part 3, Monitoring and Modeling, Sect. 10, NAS, Wash., D.C., pp. 140-58.
- 154 W.H. Munk and P.F. Worcester. Monitoring the ocean acoustically. In: *Science, Technology, and the Modern Navy — Thirtieth Anniversary, 1946-1976*, Arlington, Va., (ONR-37):497-508, 1976. Also appears under the title: Weather and climate under the sea — the Navy's habitat. In: *Science and the Future Navy — A Symposium*, Thirtieth Ann. Vol., ONR, NAS, Wash., D.C., pp. 42-52, 1977.

1978

- 151a Variable ocean structure. In: *Advances in Oceanography*, ed. H. Charnock et al., pp. 209-11, London:Plenum Press.
- 155 Visit to Tsingtao. *EOS, Trans. Am. Geophys. Union*, 59(1)4-7.
- 155a R.L. Garwin, W.H. Munk and C. Wunsch. Preliminary report on ocean acoustic monitoring. JASON Rpt. JSN 77-8.
- 155b Edward Bullard - dedication.\* In: AIP Conf. Proc. No. 46, Topics in Nonlinear Dynamics; A Tribute to Sir Edward Bullard, ed. S. Jorna, pp. v-viii., New York: Am. Inst. of Physics.
- 155c W.H. Munk and C. Wunsch. Ocean acoustic tomography: can it work (abstract only)? Invited paper, 95th Meeting: Acoust. Soc. Am., Session CC. Underwater Acoustics V: Special Session — Propagation through Fronts, Eddies and Gyres. *J. Acoust. Soc. Am.*, 63(1):S71.
- 155d Third presentation Maurice Ewing Medal to Sir Edward Bullard. *EOS, Trans. Am. Geophys. Union*, 59(8):794-95.
- 155e Professor Walter Munk at graduate commencement 1978.

1979

- 156 C. Garrett and W. Munk. Internal waves in the ocean. *Ann. Rev. Fluid Mech.*, 11:339-69.
- 157 W. Munk and C. Wunsch. Ocean acoustic tomography: a scheme for large scale monitoring. *Deep-Sea Res.*, 26A:123-61.
- 158 S.M. Flatté, R. Dashen, W.H. Munk, K.M. Watson, and F. Zachariassen. *Sound Transmission Through A Fluctuating Ocean*. Cambridge University Press, 299 pp.
- 159 J. Cairns, W. Munk and C. Winant. On the dynamics of neutrally buoyant capsules; an experimental drop in Lake Tahoe. *Deep-Sea Res.*, 26A:369-81.

1980

- 159a Introduction. In: *Oceanography in China. A Trip Report of the American Oceanography Delegation*, NAS, Wash. D.C., 106 pp.
- 160 Affairs of the sea. Prefatory Chapter in *Ann. Rev. Earth Planet. Sci.*, 8:1-16.
- 161 Horizontal deflection of acoustic paths by mesoscale eddies. *J. Phys. Oceanogr.*, 10(4):596-604.

\* "A Tribute to Sir Edward Bullard" was, in fact, written word-for-word by Sir Edward Bullard. I had just completed the presentation of the Maurice Ewing Medal to Sir Edward (155d) when I was asked to write the dedication to Sir Edward of the AIP Conference Proceedings (155b). I was in no mood to do so, and asked Teddy whether he would enjoy writing about himself what *he* thought ought to be said; it was to remain forever a secret. Teddy wrote a delightful account of his career, full of glimpses such as returning from the War and finding his Cambridge laboratory in shambles: "his first task was to scrub the floor". The manuscript was returned to me by the editors with the above quote and many others deleted. Upon protesting, I was told that Sir Edward would be gravely offended. I persisted. Teddy was so delighted with the dedication that he spilled the beans.

- 162 M.G. Brown, W.H. Munk, J.L. Spiesberger and P.F. Worcester. Long-range acoustic transmission in the Northwest Atlantic. *J. Geophys. Res.*, 85(C5):2699-2703.
- 162a Ocean acoustic tomography: a method for measuring large-scale variability. In: Proc. NOAA Workshop on Ocean Ocean Acoustic Remote Sensing, 21-24 Jan. 1980, Seattle, Wash., Vol. 2, Presentations and Working Group Reports, 4-1 through 4-10.
- 162b G.J.F. MacDonald (Chairman), *et al.* The oceans as a sink for carbon dioxide. In: *The Long-Term Impacts of Increasing Atmospheric Carbon Dioxide Levels*, JASON Tech. Rpt. No. JSR-79-04:65-82.
- 162c Walter Munk Autobiography. McGraw-Hill Modern Scientists and Engineers:339-340.
- 164 Internal wave spectra at the buoyant and inertial frequencies. *J. Phys. Oceanogr.*, 10(11), 1718-28.

1981

- 163 Internal waves and small scale processes. In: *Evolution of Physical Oceanography — Scientific Surveys in Honor of Henry Stommel*, B.A. Warren and C. Wunsch (eds.), Chapt. 9, pp. 264-91, Boston:MIT Press.
- 165 W. Munk, P. Worcester and F. Zachariassen. Scattering of sound by internal wave currents: the relation to vertical momentum flux. *J. Phys. Oceanogr.*, 2:442-54.
- 166 W. Munk, B. Zetler, J. Clark, S. Gill, D. Porter, J. Spiesberger and R. Spindel. Tidal effects on long-range sound transmission. *J. Geophys. Res.*, 86(C7):6399-6410.

1982

- 167 W. Munk and C. Wunsch. Ocean acoustic tomography: large scale climatic measurements and modelling. *Ocean Modelling*, 43:1-4.
- 168 Why is the Earth a poor timekeeper? Book review, *The Earth's Variable Rotation: Geophysical Causes and Consequences*, by Kurt Lambeck. *Geophys. J. R. Astron. Soc.*, 69:831-35.
- 168a Time series of vorticity, heat and heat flux, and upwelling in ocean gyres from long-range acoustic transmission (abstract). *EOS, Trans. Am. Geophys. Union*, 63:362.
- 170 Citation for Bowie Medalist Henry Stommel. *EOS, Trans. Am. Geophys. Union*, 63(28):522.
- 171 D. Behringer, T. Birdsall, M. Brown, B. Cornuelle, R. Heinmiller, R. Knox, K. Metzger, W. Munk, J. Spiesberger, R. Spindel, D. Webb, P. Worcester and C. Wunsch. A demonstration of ocean acoustic tomography. *Nature*, 299(5876):121-25.
- 172 W. Munk and C. Wunsch. Observing the ocean in the 1990's. *Philos. Trans. R. Soc. London.*, 307:439-64.

1983

- 173 Acoustics and ocean dynamics. In: *Oceanography: The Present and Future*, ed. P. G. Brewer, pp. 109-26, New York:Springer.
- 174 W. Munk and C. Wunsch. Up/down resolution in ocean acoustic tomography. *Deep-Sea Res.*, 29(12A):1415-36.
- 175 W. Munk and C. Wunsch. Ocean acoustic tomography: rays and modes. *Rev. Geophys. Space Phys.*, 21(4):777-93.

# THE SCIENCE AND ART OF WAVE PREDICTION — AN ODE TO HO 601

Klaus Hasselmann

*Max-Planck-Institut für Meteorologie  
Hamburg, Germany*

Happy birthday, Walter! It is wonderful to be back again in La Jolla on this occasion among old friends. I should like to thank the organizers for the honor and favor of being able to join these festivities and congratulate them for so successfully arranging this surprise symposium! It is a great pleasure to return to the laboratories where I received so many fruitful impulses in the early sixties, and to recall memories of the exciting years I experienced working with Walter Munk and his colleagues at IGPP and Scripps.

Many of those early impressions have gained a special value and flavor for me through later developments. I remember especially the occasion of my first acquaintance with Walter Munk. It was at the Easton Conference on Ocean Wave Spectra in May 1961. It was my first introduction into the international wave community, and I was listening enthralled to the spirited scientific debate of a small group of wave enthusiasts during coffee. One of the group immediately impressed me by the clarity of his physical perception and the logical persuasiveness of his arguments (and the great fun he was obviously having). When I discovered this was Walter Munk, I was amazed. I had already formed my personal image of Walter from the well-known monograph HO 601 by Sverdrup and Munk (1947) "Wind, Sea and Swell; Theory of Relations for Forecasting". It should be recalled that this pioneering work on wave prediction, developed in preparation for the allied landings during World War II, had been carried out before the concept of a power spectrum had been introduced into the field of ocean waves (a concept which Walter Munk was later to exploit so successfully). To a young scientist trained in turbulence and spectral analysis - and unable to imagine a physical world without these concepts - HO 601 appeared a strangely confused, mystical tract, based on inadequately defined intuitive concepts which seemed to basically contradict existing knowledge of surface wave dynamics. How could surface waves, for example, simply because they propagated on the ocean and were termed "significant", defy fundamental wave invariance relations and wantonly change their period with "age"? It appeared obvious (from a vantage point nearly twenty years later) that the only proper way to treat the evolution of an ocean wave field was through a transport equation describing the change in energy of individual wave components, each of fixed frequency and propagation direction, of a two-dimensional wave spectrum,

rather than in terms of arbitrary "dynamical" relations for a few selected wave parameters.

My prejudices regarding the scientist Walter Munk immediately evaporated when I met the real person, and I only too happily accepted his invitation to work with him at IGPP and Scripps. However, my reservations regarding HO 601 persisted somewhat longer. In fact, it was only quite recently, on re-reading the monograph, that the intrinsic beauty and timeless relevance of this work finally became clear to me. Since the Easton Conference, our understanding of wave dynamics has progressed significantly. It appears we have now finally reached the stage where we can properly appreciate the pioneering work of Sverdrup and Munk in the forties!

In reviewing the winding development of our view of ocean wave dynamics in the last two decades, and the various attempts to translate this view into practical wave prediction schemes, one cannot but admire the imagination and courage with which Sverdrup and Munk leapt across an abyss of ignorance to land on the same ground that was reached more than thirty years later by a sequence of painstaking theoretical studies and extensive field experiments. However, the more arduous methodological path also had its rewards in the insight it ultimately provided into the processes governing the evolution of ocean waves.

But we have not yet reached the top of the hill. A recent wave model intercomparison study (SWAMP, 1983) revealed striking differences between the predictions of current wave models for different wind conditions. The discrepancies could be attributed to differences in the form assumed for the (still largely unknown) dissipation source function, in the tuning of the input source function and, above all, in the parameterization of the nonlinear transfer (which is known exactly from theory, but is too complex for routine computation in a wave model). Significant efforts are still needed to develop wave prediction models to the degree of reliability required for routine applications. The resolution of these problems appears particularly urgent in view of current plans for launching ocean satellites later in this decade which could provide quasi-synoptic global wind and wave data for a host of wave forecasting applications. The enormous potential of this greatly expanded data base can be clearly exploited only if reliable wave models are available.

### First Generation Wave Models

The introduction of the spectral description of sea state by Pierson, Neumann and James (1955) led naturally to a change from the original empirical wave prediction methods in terms of a few characteristic wave parameters, pioneered in HO 601, to more sophisticated numerical wave forecasting techniques based on the integration of the fundamental differential spectral transport equation

$$\frac{DF}{Dt} = \frac{\partial F}{\partial t} + \mathbf{v} \cdot \nabla F = S \quad (1)$$

describing the evolution of the full two-dimensional wave spectrum  $F(f, \theta, \mathbf{x}, t)$  with respect to frequency  $f$  and direction  $\theta$  as a function of position  $\mathbf{x}$  and time  $t$ . The left-hand side of equation (1) represents the rate of change of the energy of a particular wave component  $(f, \theta)$  propagating at its group velocity  $\mathbf{v} = g/4\pi f$  ( $g$  = gravitational acceleration) in the direction  $\theta$ , while the source function on the right-hand side describes the net energy input or loss of the component.

The source function of the first wave model based on the transport equation (1) (Gelci *et al.*, 1957) had to be constructed almost entirely through a combination of conjecture and empiricism, since very little was known at the time about the details of the dynamical processes governing the spectral energy balance. However, a series of theoretical investigations on the generation of waves by wind (Miles, 1957; Phillips, 1957), the high frequency equilibrium range of the spectrum (Phillips, 1958) and the nonlinear transfer due to wave-wave interactions (Phillips, 1960; Hasselmann, 1960, 1962, 1963a,b) soon provided a theoretical framework for the general structure of the source function, which has since been adopted in most wave models.

The source function is normally decomposed into three constituents,  $S = S_{in} + S_{nl} + S_{ds}$ , representing, respectively, the energy input by the wind, the nonlinear energy transfer due to wave-wave interactions and dissipation due to white capping, turbulence, or other processes. Our understanding of the relative role of these three terms has changed considerably between the first generation models, introduced in the sixties shortly after the first spate of wave dynamical theories appeared, and the second generation models developed later in the seventies, when more field data had become available to test the original concepts.

In the first generation models, the input source function was generally represented as a superposition  $S_{in} = \alpha + \beta F$  of an external forcing term  $\alpha$  corresponding to Phillips' (1957) turbulent pressure generating term and a Miles (1957)-Jeffreys (1924) linear-feedback growth term  $\beta F$ . However, to obtain good agreement with observed growth rates,  $\alpha$  had to be set several orders of magnitude greater than estimates based on turbulence measurements, and  $\beta$  also had to be chosen almost an order of magnitude greater than the theoretical estimates of Miles or Jeffreys.

The nonlinear source function  $S_{nl}$  was either ignored entirely or parameterized rather simply from Hasselmann's (1963b) computations of  $S_{nl}$  for a fully developed Roll-Neumann spectrum. The inclusion of  $S_{nl}$  in this form modified, but did not dramatically change, the model prediction.

Phillips' concept of a universal equilibrium spectrum, finally, removed the need to specify the dissipative source function  $S_{ds}$  for windseas. A particular spectral component was assumed to grow without significant dissipation until it reached Phillips' equilibrium form,  $F(f, \theta) = \alpha (2\pi)^{-4} g^2 f^{-5} D(\theta)$ , ( $\alpha$  = Phillips universal constant,  $D(\theta)$  = directional spreading factor), where saturation occurred. Most models included some explicit dissipation for swell, however.

The first generation models were attractively simple: they described a spectral ensemble of essentially independent waves which propagated and dispersed in accordance with classical linear dispersion relations, grew in accordance with simple, theoretically plausible laws, and exhibited relatively weak, if any, nonlinear coupling below the universal saturation level (for a review of first generation models, cf. SWAMP, 1983). There was no discernible similarity to HO 601, but this disturbed no one, since HO 601 was clearly conceptually outmoded. The order of magnitude discrepancy between prior estimates of the Miles-Phillips input source function coefficients and the values actually used in the tuned models was not too embarrassing: everyone appreciated the difficulties of computing the interactions between a turbulent atmospheric boundary layer and the surface wave field from first principles.

A little more disconcerting, perhaps, was the overshoot phenomenon first discovered by Barnett and Wilkerson (1967). In measurements with an airborne radar altimeter in an offshore wind field, they found that the individual spectral components of the developing fetch limited windsea grew beyond the Phillips saturation level by a significant factor (of the order of two) before decaying again to an asymptotic equilibrium level. This was difficult to explain by the simple quasi-linear source functions used in the first generation models. However, the overshoot effect was found in only one experiment, and had not been noticed in the earlier extensive growth measurements with towed wave buoys by Snyder and Cox (1966). Fortunately, there existed few other definitive measurements to disturb the general tranquility.

### Second Generation Models

The collapse of this picture was initiated by Walter Munk. Already in the early sixties, he had recognized that the critical data base needed to test ocean wave theories seriously could be obtained only by large scale field programs designed to monitor the changes of the wave spectrum in both space and time over a longer, continuous measurement period.

To demonstrate the approach, he distributed an assortment of IGPP graduate students, professors, technicians, scientists and visitors uniformly along a great circle spanning the Pacific from New Zealand to Alaska. The goal of the experiment was to track swell from southern winter storms and measure its decay as it propagated northwards across the ocean. To everybody's surprise, no significant decay was observed. I think Walter was a little disappointed. However, the null result of this technically highly successful experiment (Snodgrass *et al.*, 1966) has proved of fundamental importance for wave modelling. The experiment also pointed for the first time to the significance of nonlinear interactions in

the transformation of windsea into swell as waves leave a generating region — a complex problem which has not yet been satisfactorily resolved in modern wave models.

Other groups emulated this example. The application of the measurement strategy to the study of fetch limited wave growth then led to a completely different view of the energy balance of a windsea spectrum (Mitsuyasu, 1968, 1969; Mitsuyasu *et al.*, 1971; Hasselmann *et al.*, 1973).

The principal experimental finding of these extensive fetch limited growth studies was that the spectrum of a growing windsea exhibited a significantly sharper peak than had previously been assumed — corroborating the overshoot effect found previously by Barnett and Wilkerson (cf. Figures 1a and 1b).

Computations of the nonlinear wave-wave interactions for the new spectral form yielded transfer rates an order of magnitude larger than had been computed previously for fully developed Pierson-Neumann or Pierson-Moskowitz spectral distributions (Hasselmann, 1963b; Cartwright, 1966, unpublished report; Snodgrass *et al.*, 1966). With the revised computations it was now possible to explain the growth rate of newly developing waves on the low frequency forward face of the spectrum almost entirely in terms of the transfer of energy from higher frequency wave components slightly to the right of the peak (a somewhat larger transfer of energy occurred also from the region to the right of the peak to higher frequencies). The required residual wind input to the

growing wave components on the forward face of the spectrum could accordingly be reduced by almost an order of magnitude relative to the first generation models to values compatible with theory. The smaller wind input values have since been confirmed by Snyder *et al.* (1981) through direct measurement of the work done by the atmospheric pressure forces acting on the moving wave surface.

The experiments showed further that the concept of a universal high frequency equilibrium spectrum determined solely by wave breaking was untenable: the shape of the spectrum both near the peak and at higher frequencies was controlled largely by the nonlinear transfer, while the actual energy level of the spectrum (Phillips' "constant"  $\alpha$ ) depended also on the wind input, i.e. on the local wind strength and the stage of development of the windsea.

The revised energy balance which emerged from these experiments was fundamentally nonlinear, the resonant wave-wave interactions playing a key role both in maintaining a quasi-equilibrium spectral distribution and in shifting the distribution towards lower frequencies (cf. Figure 2).

Although the new picture was conceptually straightforward, it posed severe problems for numerical wave models. The nonlinear coupling implied that waves propagating along different rays could no longer be treated independently. More importantly, a more sophisticated parameterization of the nonlinear transfer was needed which was able to reproduce the essential properties of the complex exact integral

## FETCH LIMITED WAVE GROWTH

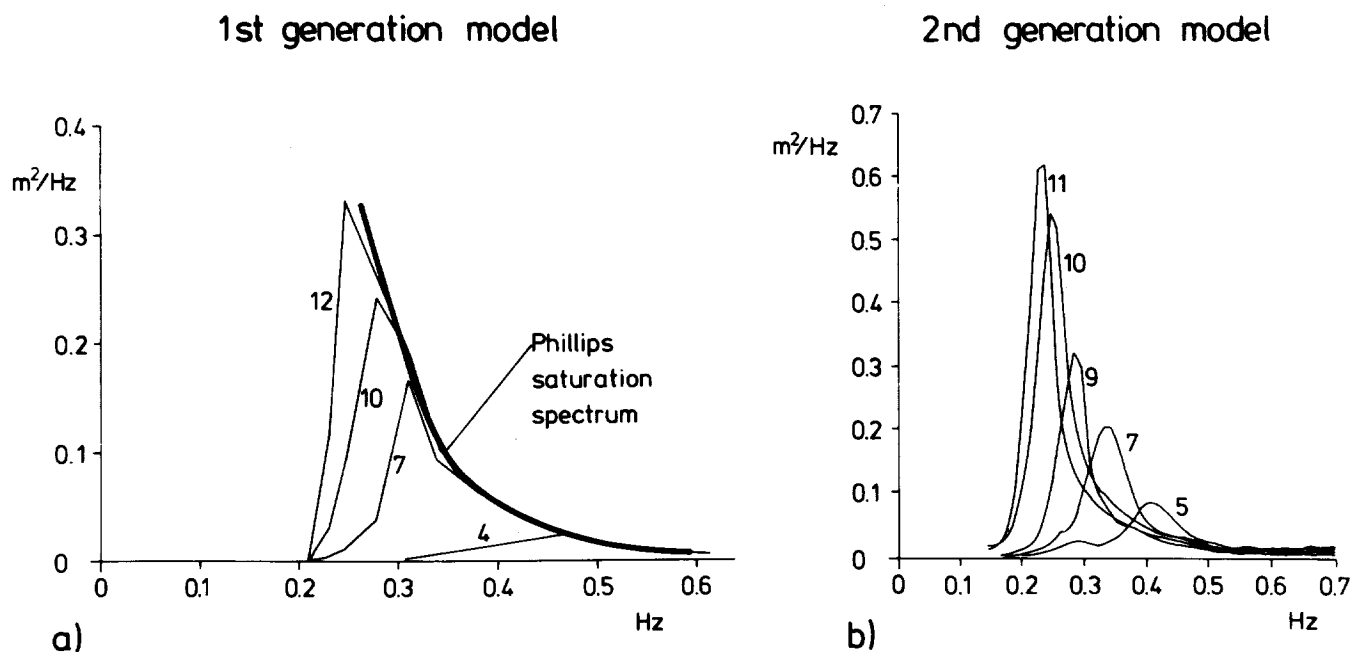

Figure 1. Fetch limited wave growth (increasing station number corresponds to increasing fetch)  
 a) first generation models: nested growth of spectra limited by Phillips' universal equilibrium spectrum (from SWAMP, 1983, VENICE model);  
 b) second generation models: sharply peaked spectra produce overshoot, level of high frequency spectrum decreases slowly with fetch (from JONSWAP, Hasselmann *et al.*, 1973).

# ENERGY BALANCE

1st generation models

2nd generation models

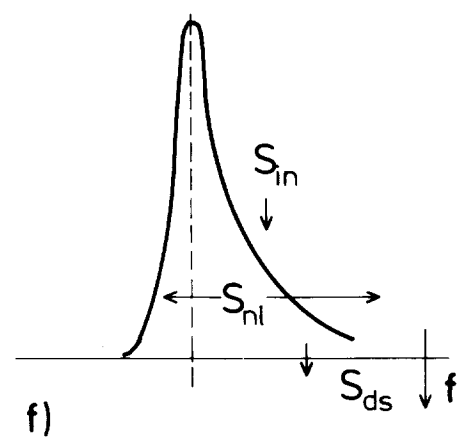
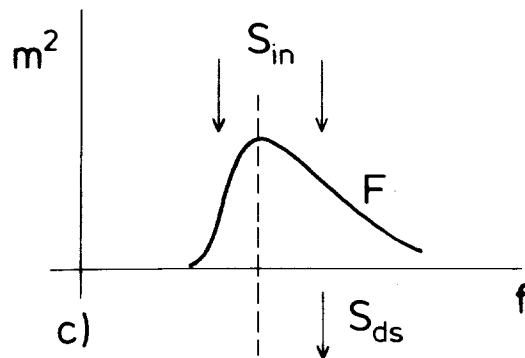
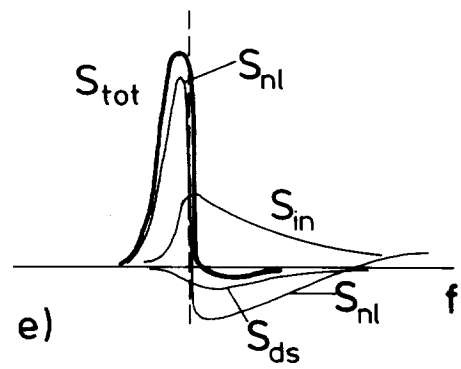
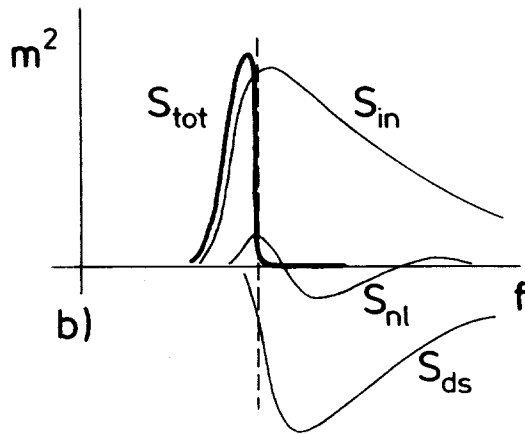
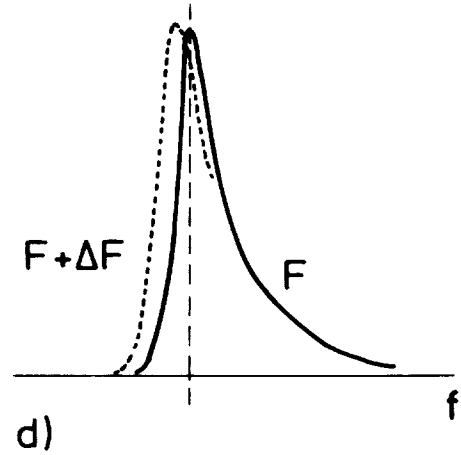
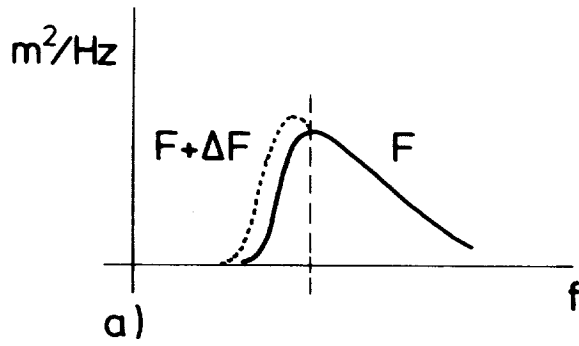

Figure 2. Energy balance of fetch limited spectra for first and second generation models

a), d): spectral distributions  $F$  and net change  $\Delta F$  in distance  $\Delta x$

b), e): the three source functions  $S_{in}$ ,  $S_{nl}$  and  $S_{ds}$  with net source functions  $S_{tot} = S_{in} + S_{nl} + S_{ds} = S$

c), f): qualitative structure of the energy balance.

expression, in particular the self-stabilization of the spectral shape and the migration of the peak towards lower frequencies.

A number of such parameterizations have been considered. However, on the basis of the SWAMP (1983) study it must be concluded that none of the parameterizations used in current second generation models are truly satisfactory. For example, all present parameterizations exhibit severe shortcomings in the treatment of confused seas generated by rapidly varying windfields, and in the simulation of the transition from a windsea spectrum to swell in regions of decaying winds. In general, the parameterizations become questionable whenever the advection terms become of the same order as the nonlinear transfer and the spectrum does not have enough time to adjust locally to a quasi-universal spectral distribution. Although this condition is normally satisfied for growing windseas generated by typical synoptic scale wind fields, the advection terms become important if the wind field varies rapidly over small distances and, generally, at the edge of generating regions, where the waves disperse and the nonlinearities become weaker.

On the other hand, if one ignores these difficulties and limits oneself at the outset to the "normal" wave growth case, a much simpler wave model can, in fact, be constructed by an alternative approach: by re-inventing HO 601. Since the windsea spectrum adjusts rapidly to a quasi-universal form, there is no need to predict the entire two-dimensional spectrum. The spectrum can be characterized completely by only two dimensional parameters which define the frequency scale (e.g. the peak frequency  $f_p$ , or alternatively the significant wave period  $T_s$ ) and an energy scale (e.g. the total energy of the spectrum  $E = (H_s/4)^2$ , where  $H_s$  is the significant wave height).

The prognostic equations for  $f_p$  and  $E$  (or  $T_s$  and  $H_s$ ) can be derived from the full spectral transport equation by projection on to these parameters. One obtains equations of the form

$$\frac{\partial f_p}{\partial t} + v_p \frac{\partial f_p}{\partial s} = S_p \quad (2)$$

$$\frac{\partial E}{\partial t} + v_E \frac{\partial E}{\partial s} = S_E \quad (3)$$

where  $v_p$ ,  $S_p$  represent the effective propagation velocity and source function, respectively, for the parameter  $f_p$ , and  $v_E$ ,  $S_E$  denote the corresponding terms for the parameter  $E$ . The spatial derivative  $\frac{\partial}{\partial s}$  is taken in the direction parallel to the local wind direction. The quantities  $v_p$ ,  $v_E$ ,  $S_p$  and  $S_E$  represent known functions of the parameters  $f_p$  and  $E$  which can be determined from the shape of the spectrum and the source function of the full spectral transport equation. Details are given in Hasselmann *et al.* (1976).

The projection technique can be applied to any model in which the spectrum is characterized by a finite number of parameters. Normally, the parametrical treatment of the evolution of the windsea spectrum is then combined with a standard linear spectral model for swell propagation in a hybrid model.

In current hybrid models, the prognostic windsea equations (2), (3) are generally reduced still further to a single prognostic equation by assuming that  $E$  and  $f_p$  are diagnostically related,  $E = E(f_p, U)$ , where  $U$  is the wind speed. One obtains in this manner a single prognostic equation for  $E$  for example,

$$\frac{\partial E}{\partial t} + v_E \frac{\partial E}{\partial s} = S_E(E, U) \quad (4)$$

The additional reduction step is consistent with the assumed structure of the spectral energy balance, since not only the shape but also the energy level of the spectrum adjusts to a quasi-equilibrium state on a time scale which is short compared with the time scale characterizing the rate of shift of the peak frequency or the growth in total windsea energy.

The description of wind wave growth in terms of a single prognostic wave parameter is precisely the approach used in HO 601. In retrospect, the representation of ocean wind waves in terms of a "significant wave", whose amplitude and period are interrelated, and which changes its period with "age", no longer appears as a disturbing contradiction to basic fluid dynamics, but is recognized simply as a concise first order characterization of a statistical ensemble of waves which are indeed not independent, as assumed in classical linear wave theory, but interact to form a quasi-equilibrium spectral distribution which can be characterized by one or two slowly varying scale parameters.

#### A Data Comparison

Since wave theory was virtually non-existent at the time, the growth curves of HO 601 had to be derived entirely from empirical data. Although modern hybrid models are founded more strongly on theory, empirical growth data are invoked to tune these models too. A data comparison is therefore of some historical interest.

The data base for HO 601 consisted largely of visual observations, including "... observations by a weather officer during the invasion of Normandy ...", "... some casual observations at Dover ...", and "... data ... from a pond at Kensington Park ...". Modern models are tuned against extensive spectral measurements obtained with intercalibrated instruments under well-defined fetch limited growth conditions. A comparison of the HO 601 and modern data, together with the appropriate model growth curves, is given in Figure 3. The progress in measurement techniques has clearly been commensurate with the progress in wave modelling!

#### Outlook into the Future

Despite our improved insight into the spectral energy balance of ocean waves and our belated understanding of HO 601, the present second generation wave models still exhibit basic shortcomings. As pointed out, they fail to model wind wave growth reliably for strongly inhomogeneous wind fields such as hurricanes, storms or strong fronts. Although not very significant for mean statistics, these extreme situations are clearly of particular interest for applications. Furthermore, the models are inaccurate in providing initial values for swell propagation, since the windsea-swell

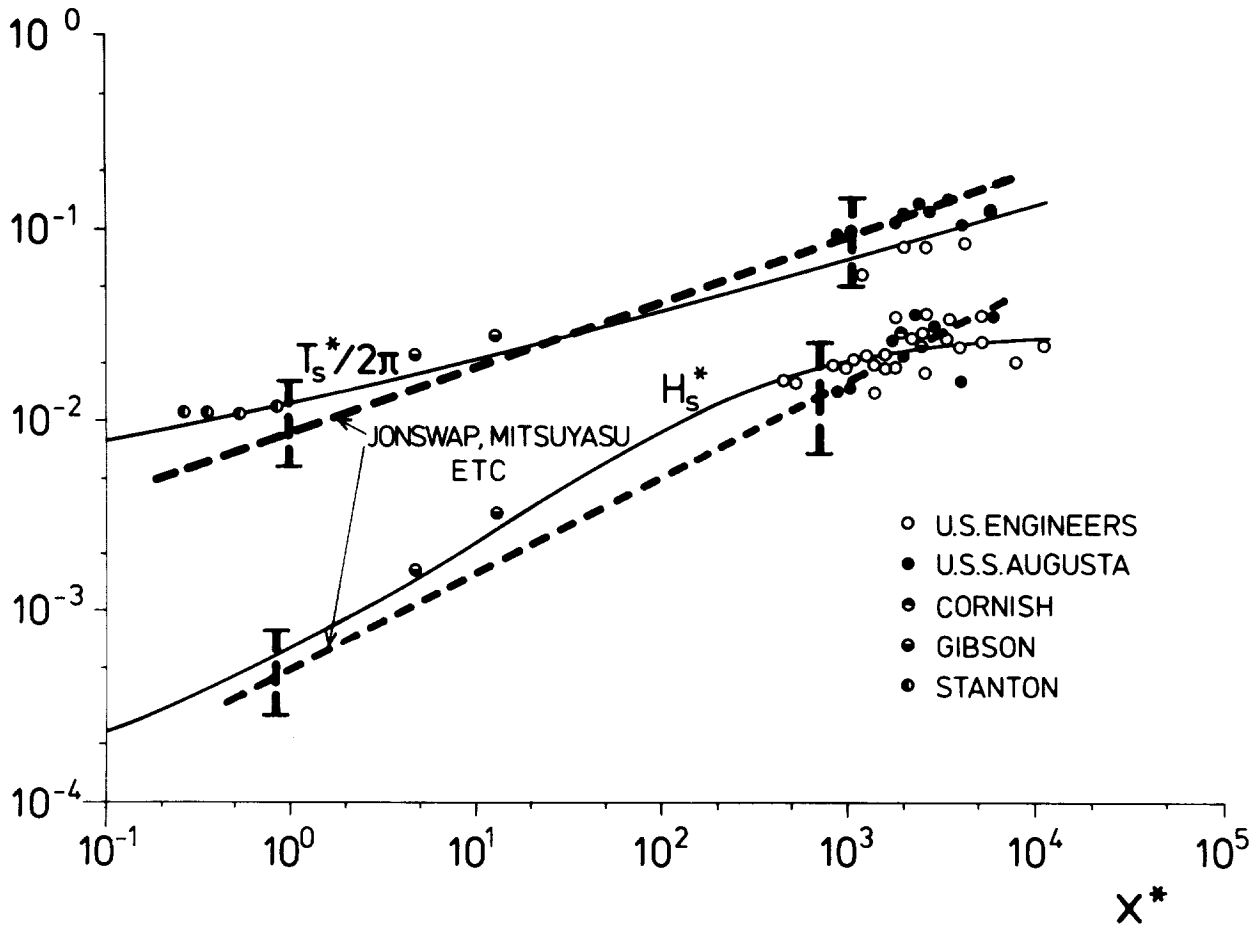

Figure 3. Comparison of HO 601 growth data and model curves with modern data. The dimensionless variables shown are  $T_s^* = T_s g / U$ ,  $H_s^* = H_s g / U^2$ ,  $x^* = \text{fetch} \cdot g / U^2$ . ( $T_s^* / 2\pi = c / U$ , where  $c$  is the wave phase velocity.) The significant wave period  $T$  from visual observations has been equated with the inverse of the peak frequency  $f_p$  from spectral data.

transition regime is treated inadequately. In both cases the basic physics is believed to be understood. The problems arise principally through limitations in the parameterization of the nonlinear transfer.

It appears questionable whether an extension of the parametrical approach used in HO 601 and present hybrid models can overcome these difficulties. Any representation of the spectrum in terms of relatively few parameters must break down when the nonlinear transfer is no longer large compared with the advective terms in the spectral transport equation and the windsea spectrum begins to respond freely with its (theoretically) unlimited number of degrees of freedom to the full space-time variability of the forcing wind field.

Models in which a complete two-dimensional discrete representation of the spectrum is maintained for both the windsea and swell regimes should basically be able to cope with such non-equilibrium windsea situations. However, the present discrete spectral models also have difficulties with these cases. The parameterizations of  $S_{nl}$  used in these models are usually derived from computations of the exact Boltzmann integral expression for  $S_{nl}$  for a finite set of parameterized windsea spectra. Thus although the spectrum itself is free to adopt all the degrees of freedom of a discrete

two-dimensional representation (typically a few hundred), the nonlinear transfer is in effect still restricted to a parameter space of only very few dimensions. Numerical experiments show that for arbitrary input and dissipation functions this mismatch normally leads to instabilities: the restricted nonlinear transfer is unable to adjust the imbalance between the different spectral distributions of  $S_{in}$  and  $S_{ds}$ , resulting in unstably growing perturbations of the spectral shape. (In contrast, experiments with the exact expression for  $S_{nl}$  yielded stable spectral distributions similar to observed spectra for a wide range of input and dissipation source functions, cf. Hasselmann and Hasselmann, 1983.) To counteract this instability, present second generation discrete spectral models generally apply various techniques to limit the number of degrees of freedom of the windsea spectrum. This essentially reduces the discrete models to hybrid models.

A possible solution to these difficulties is to construct operator rather than parametrical function approximations to the exact nonlinear transfer expression. The output  $S_{nl}$  of the operator approximation should contain the same number of degrees of freedom as the input spectrum. A number of operator approximations have recently been tested with rather encouraging results (Hasselmann *et al.*, in preparation).



The introduction of generalized operator parameterizations of  $S_{nl}$  would open the way for more systematic investigations of the influence of the least known source function, the dissipation  $S_{ds}$ , on the evolution of the wave spectrum (cf. Komen and Bouws 1984, and Komen *et al.*, in preparation). In present second generation models,  $S_{ds}$  and the other source functions are in effect treated collectively in the parametrical description of the high frequency part of the spectrum, whose net energy balance is still determined empirically.

With some optimism we may therefore predict in the next years the advent of third generation discrete wave models in which the energy balance of the entire two-dimensional wave spectrum is finally treated explicitly in terms of the three basic source functions  $S_m$ ,  $S_{nl}$  and  $S_{ds}$ , without recourse to predefined spectral distributions. This would represent a courageous step beyond HO 601. But the enticing blend of science and art which this monograph first introduced into the field of wave prediction will undoubtedly also survive these advances.

#### References

- Barnett, T.P. and J.C. Wilkerson. 1967. On the generation of ocean wind waves as inferred from airborne radar measurements of fetch-limited spectra. *J. Marine Res.*, **25**, 292.
- Gelci, R., H. Cazalé and J. Vassal. 1957. Prévission de la houle, La méthode des densités spectroangulaires, *Bull. Inform. Comité Central Oceanogr. d'Etude Côtes*, **9**, 416.
- Hasselmann, K. 1960. Grundgleichungen der Seegangsvoraussage. *Schiffstechnik, Bd.*, **7**, 191.
- Hasselmann, K. 1962. On the nonlinear energy transfer in a gravity-wave spectrum, 1: General Theory. *J. Fluid Mech.*, **12**, 481.
- Hasselmann, K. 1963a. On the nonlinear energy transfer in a gravity-wave spectrum, 2: Conservation theorems, wave-particle correspondence, irreversibility. *J. Fluid Mech.*, **15**, 273.
- Hasselmann, K. 1963b. On the nonlinear energy transfer in a gravity-wave spectrum, 3: Computation of the energy flux and swell-sea interaction for a Neumann spectrum. *J. Fluid Mech.*, **15**, 385.
- Hasselmann, K., T.P. Barnett, E. Bouws, H. Carlson, D.E. Cartwright, K. Enke, J.A. Ewing, H. Gienapp, D.E. Hasselmann, P. Kruseman, A. Meerburg, P. Müller, D.J. Olbers, K. Richter, W. Sell and H. Walden. 1973. Measurements of wind-wave growth and swell decay during the Joint North Sea Wave Project (JONSWAP). *Deutsche Hydrogr. Z.*, A (8°), No. 12.
- Hasselmann, K., D.B. Ross, P. Müller and W. Sell. 1976. A parametric wave prediction model. *J. Phys. Oceanogr.*, **6**, 200.
- Hasselmann, S. and K. Hasselmann. 1983. Integrations of the spectral transport equation with exact and parametrical computation of the nonlinear energy transfer. *Proc. Symp. Wave Dynamics and Radio Probing of Ocean Surface*, Miami, 1981.
- Jeffreys, H. 1924. On the formation of waves by wind. *Proc. R. Soc.*, A **107**, 189.
- Komen, G.J. and E. Bouws. 1984. On the balance between growth and dissipation in an extreme depth limited windsea in the southern North Sea (subm. for publication).
- Miles, J.W. 1957. On the generation of surface waves by shear flows. *J. Fluid Mech.*, **3**, 185.
- Mitsuyasu, H. 1968. On the growth of the spectrum of wind-generated waves, 1 Rep. Res. Inst. Appl. Mech., Kyushu Univ. **16** 459.
- Mitsuyasu, H. 1969. On the growth of the spectrum of wind-generated waves, 2. Rep. Res. Inst. Appl. Mech., Kyushu Univ. **17**, 235.
- Mitsuyasu, H., R. Nakayama and T. Komori. 1971. Observations of the wind and waves in Hakata Bay. Rep. Res. Inst. Appl. Mech., Kyushu Univ. **19**, 37.
- Phillips, O.M. 1957. On the generation of waves by turbulent wind. *J. Fluid Mech.*, **2**, 417.
- Phillips, O.M. 1958. The equilibrium range in the spectrum of wind-generated ocean waves. *J. Fluid Mech.*, **4**, 426.
- Phillips, O.M. 1960. On the dynamics of unsteady gravity waves of finite amplitude, Part 1. The elementary interactions, *J. Fluid Mech.*, **9**, 193.
- Pierson, W.J., G. Neumann and R.W. James. 1955. Practical methods for observing and forecasting ocean waves by means of wave spectra and statistics, U.S. Navy Dept., Hydrogr. Off. Pub. No. 603, Wash.
- Snodgrass, F.E., G.W. Groves, K.F. Hasselmann, G.R. Miller, W.H. Munk and W.H. Powers. 1966. Propagation of ocean swell across the Pacific. *Phil. Trans. R. Soc.*, A **259**, 431.
- Snyder, R.L. and C.S. Cox. 1966. A field study of the wind generation of ocean waves. *J. Mar. Res.*, **24**, 141.
- Snyder, R.L., F.W. Dobson, J.A. Elliott and R.B. Long. 1981. Array measurements of atmospheric pressure fluctuations above surface gravity waves. *J. Fluid Mech.*, **102**, 1.
- Sverdrup, H.U. and W.H. Munk. 1947. Wind, Sea and Swell: Theory of Relations for Forecasting. U.S. Hydrographic Office, Tech. Rep. No. 1, HO Publ. No. 601.
- SWAMP (1983). The SWAMP group. Sea Wave Modelling Project, Part 1: Principal Results and Conclusions, *Proceedings IUCRM Symposium on Wave Dynamics and Radio Probing of the Ocean Surface, May 1981*.

# TURNING POINTS IN UNIVERSAL SPECULATION ON INTERNAL WAVES

Christopher Garrett

*Department of Oceanography  
Dalhousie University  
Halifax, Nova Scotia  
Canada*

## **An Informal Introduction**

It's always a pleasure to visit Scripps, and particularly on this festive occasion. Happy Birthday, Walter!

My talk will be about internal waves, a topic on which I had the great privilege of working for a while with Walter, as an alphabetically senior, but otherwise very junior, assistant. My involvement with the subject since then has been rather intermittent, so I do not propose to present either a thorough up-to-date review of the subject, or a complete history. To do so would, in any case, be slightly redundant, given the reviews that have been written recently by Gregg and Briscoe (1979), by Munk (1981), by Olbers (1983) and by various other authors. Indeed the subject is in some danger of reaching the mature phase of many scientific topics, in which the number of reviews being written exceeds the number of worthwhile new papers.

Instead, I will attempt a discussion of whether we are any nearer achievement of the objectives that I think Walter had in mind some 12 years ago when he turned his attention seriously to the subject. I will not be able to do this as clearly as Walter could; I have often accused him of not letting the truth get in the way of a good seminar, but there's more than that to his talent as a speaker.

I arrived at IGPP in 1969 as a post-doctoral fellow, and was put to work, by John Miles and Walter Munk, on some surface wave problems relevant to the engineering design of an artificial offshore island that had been proposed by Scripps. I actually wanted to work with Walter on tidal problems; we did manage one joint paper (Garrett and Munk, 1971) on "the age of the tide", extending earlier work by Pliny the Elder in the 1st century and William Whewell in the 19th, but by 1970 Walter seemed to have decided that the problems of ocean tides were soluble, and hence no longer sufficiently challenging (I'm not convinced that he was right).

In 1970 Walter had read a stimulating paper by Michael Longuet-Higgins (1969) on the statistics of surface wave breaking. With some clever arguments on the frequency of wave breaking, Longuet-Higgins obtained a value for the Phillips saturation constant that was in surprisingly good agreement with observations. (It is this ability, to get a much

better answer than should be expected in view of the approximations made, that is one of the hallmarks of a great scientist.) It occurred to Walter that it might be possible to extend this approach to internal wave breaking, and hence obtain a value for the associated vertical eddy diffusivity that could be compared with the value of  $10^{-4} \text{ m}^2\text{s}^{-1}$  proposed in his classic "abyssal recipe" paper (Munk, 1966). To pursue this idea it was necessary to have an accurate statistical description of the internal waves present in the ocean at any place and time, a formidable task.

I suspect that Walter's enthusiasm at the time for this particular topic met with the same reception as many of his other ventures, with comments like "He's done some nice things in the past, but he's really gone overboard this time — the problem's impossible." One of Walter's great talents has been his ability to identify important topics, regarded by others as intractable, where progress can be made. Each time he demonstrates this the criticism of the rest of us slowly turns to admiration.

## **Internal Waves**

Parcels of water in the ocean interior move up and down on time scales of hours, with vertical displacements of the order of 10 m (Figure 1). The associated horizontal currents are of the order of  $0.1 \text{ ms}^{-1}$  (Figure 2). These motions are due to internal waves, which can exist for a wide range of frequencies and vertical wavenumbers. The data of Figure 1 provide information on the amount of energy at each frequency, but not on the distribution of energy, at each frequency, over the range of possible wavenumbers. Likewise the data of Figure 2 provide information on the vertical wavenumber spectrum, but not on the frequency content (apart from showing, from the reversal of much of the structure after about half an inertial period, that there is considerable energy near the inertial frequency). However, it was possible to fit simple models for the distribution of energy in frequency-wavenumber space (Figure 3) to data of the sort shown in Figures 1 and 2, and to data from simple arrays of sensors.

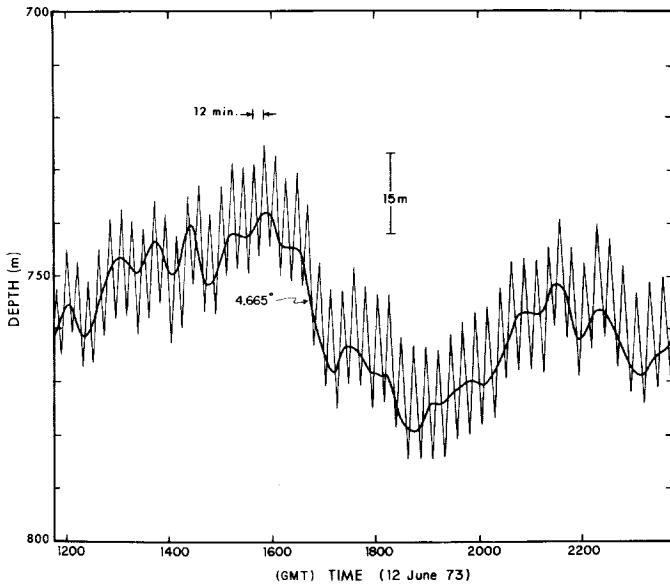

Figure 1. The depth of a particular isotherm (heavy line) as measured by a drifting, yo-yoing, float (from Cairns, 1975).

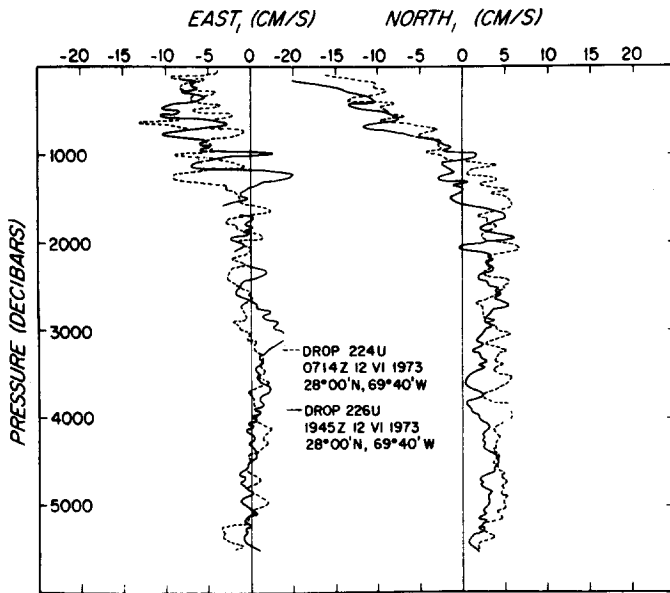

Figure 2. Vertical profiles of horizontal current components. The solid and dashed lines correspond to profiles measured 12.5 hours apart (from Sanford, 1975).

Until the IWEX experiment (Müller *et al.*, 1978) adequate information for the determination of model parameters could only be obtained by using data from different sorts of experiments that were widely separated in space and time. It had to be assumed that the internal wave field was fairly universal, i.e., pretty much the same for all places and times. The surprising degree of success of this assumption meant that model spectra like that shown in Figure 3, or later refinements (e.g. Cairns and Williams, 1976), could be used in consideration of the dynamics of the internal waves themselves, or in applications to acoustic propagation problems (Flatté *et al.*, 1979) and other topics.

An unfortunate side effect of the apparent universality of the deep ocean internal wave spectrum has been "a tendency for purely descriptive work on internal waves to be inhibited" (Gregg and Briscoe, 1979). Perhaps this is partly a tribute to Walter Munk. The Canadian oceanographer R.W. Stewart has pointed out that the stature of a scientist may be measured by the length of time for which he holds up the development of a field, and backs up this premise with clear examples from surface wave generation theory. Walter's impact on internal wave research may appear, as remarked by Gregg and Briscoe (1979), to have been inhibiting, but there has, in fact, been a steady stream of papers discussing departures from the universal spectral form: near the surface (e.g. Pinkel, 1975), in a variety of special geographical locations (e.g. Wunsch and Webb, 1979) and near a sloping sea floor (Eriksen, 1982). The existence of a basic framework has helped to focus these studies rather than inhibit them; we must conclude that it is now harder than it used to be for someone of Walter's stature to hold up developments.

### Kinematic Models of Internal Wave Breaking

An adequate description of the internal wave field in the ocean should permit one to follow Michael Longuet-Higgins' (1969) example for surface waves, and calculate the statistics of internal wave breaking in the ocean. A key connection between internal wave breaking (which leads to a local increase in the potential energy of the water column) and the vertical eddy diffusivity  $K_v$  is obtained from consideration of the rate of change of the potential energy of a volume within which some mixing is occurring. Ignoring molecular diffusion, and assuming zero mean flow, the density equation is, with an overbar representing an ensemble average:

$$\partial \bar{\rho} / \partial t + \nabla \cdot (\bar{\rho} \underline{u}') = 0 \quad (3.1)$$

so that the equation for the rate of change of potential energy is

$$\frac{\partial}{\partial t} \int g \bar{\rho} z dV = - \int g z \frac{\partial}{\partial z} (\bar{\rho} \underline{w}') dV \quad (3.2)$$

with the horizontal eddy flux terms integrating to zero if one assumes horizontal homogeneity. Integration by parts leads to

$$\begin{aligned} \partial (P.E.) / \partial t &= \int g \bar{\rho}' \underline{w}' dV = \int -g K_v \partial \bar{\rho} / \partial z dV \\ &= \int K_v \bar{\rho} N^2 dV \end{aligned} \quad (3.3)$$

so that  $K_v$  may be estimated from a model for the rate of change of the potential energy that arises from wave breaking.

The simplest model is one in which shear instability leads to complete homogenisation, of a previously linear density gradient, over a depth  $H$ . The change in potential energy of this layer, per unit horizontal area, is then  $(1/12) \bar{\rho} N^2 H^3$ . It is then necessary to estimate the frequency of instabilities as a function of  $H$  and integrate. Walter and I attempted this (Garrett and Munk, 1972), using a rather naïve model spectrum that lacked adequate energy at high wave numbers, on the assumption that shear instability would occur whenever the local Richardson number dropped to 0.25, and would

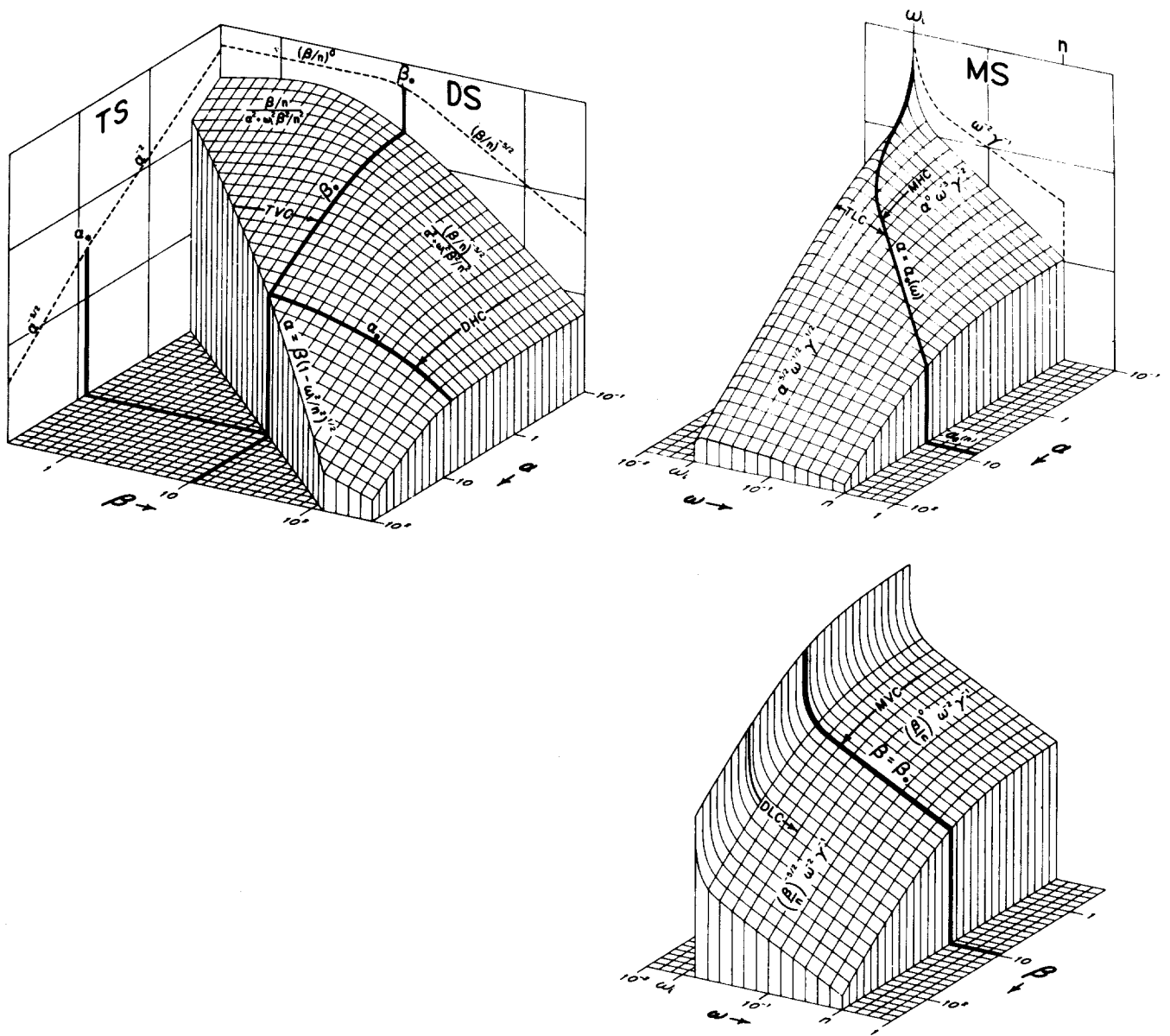

Figure 3. A model for the distribution of energy in wavenumber-wavenumber or wavenumber-frequency space (Garrett and Munk, 1975).

immediately mix the fluid over a depth with a bulk Richardson number of about 0.4 (as seemed to occur in Thorpe's (1971) laboratory experiments). The results were implausible, not only because of the erroneous model spectrum, but also because of uncertainty in the statistical arguments used to estimate the frequency of mixing events. (Tolerant referees and editors permitted us a footnote to the effect that Walter and I disagreed with each other by a factor of  $10^7$ ; I wonder if Walter has had this big a disagreement with any of his other colleagues!)

The basic result of such a model is that  $K_v$  is given approximately by  $(1/12)H^2T_e^{-1}$ , with  $H$  the typical mixing scale and  $T_e$  the time between mixing events in a depth interval  $H$ . Estimates for  $H$  may be made for any choice of the vertical wavenumber spectrum of horizontal shear, as discussed by Garrett (1979). For the recent shear spectrum

(Figure 4) synthesized from observations by Garrett *et al.* (1981), terminated at a vertical wavenumber of about 1 cycle  $m^{-1}$  (where the Richardson number based on the r.m.s. shear is about 1/4 and a transition to turbulence seems to occur), one finds  $H \approx 1$  m.

The time  $T_e$  between events is harder to estimate, though Garrett and Munk (1972) calculated that the time between maxima of the shear amplitude is about 0.8 times the geometric mean of the inertial and Väisälä periods, or roughly 6 hours for the main thermocline at mid-latitudes. Taking this for  $T_e$ , i.e. assuming that waves break at every shear maximum, leads to  $K_v \approx 4 \times 10^{-6} m^2s^{-1}$ .

A more elaborate treatment of shear statistics, in space, has been presented by Desaubies and Smith (1982), although their model only mixes over any depth for which the bulk Richardson number drops below 0.25 (rather than extending

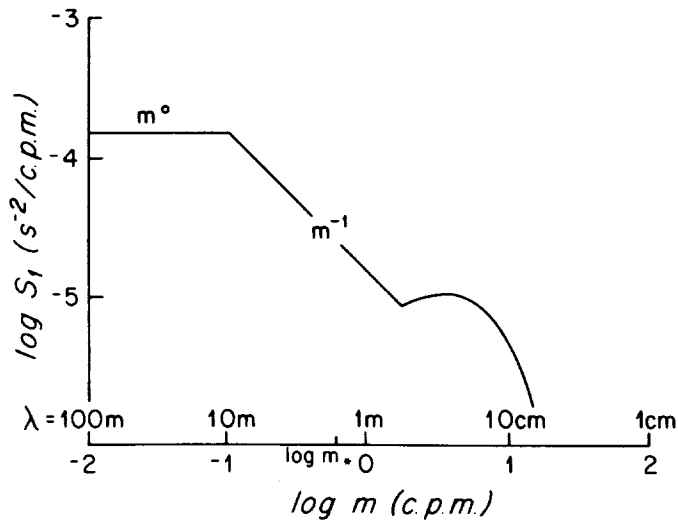

Figure 4. Schematic of the observed wavenumber spectrum of the vertical shear of one component of the horizontal current (from Gargett et al., 1981).

the mixing region to the depth over which  $Ri = 0.4$ ). These authors also have to "guesstimate" the time interval between mixing events. They take  $N^{-1}$  as the time interval between independent shear profiles which are examined for regions, with  $Ri < 0.25$ , which are then mixed.

The significant results of these estimates from the kinematics of the observed internal wave field are that mixing events are rather thin (a metre or two in height) and cannot occur frequently enough to give a vertical eddy diffusivity of more than about  $10^{-5} \text{ m}^2 \text{ s}^{-1}$ . Both of these predictions are broadly consistent with microstructure measurements in the thermocline (e.g. Gregg and Briscoe, 1979; Gregg, 1980).

In another very interesting recent study, Evans (1982) has examined simultaneous profiles of shear and density observed in the North Atlantic, rather than the synthetic profiles analyzed by Desaubies and Smith (1982). He found that up to 5% of each profile was occupied by regions, typically 2 to 4 m thick but occasionally more or less, over which the Richardson number was less than 0.25. He then estimated a vertical eddy diffusivity by hypothesizing perfect mixing over these regions, obtaining  $K_v = 1$  to  $4 \times 10^{-5} \text{ m}^2 \text{ s}^{-1}$  away from the Gulf Stream, somewhat more in it. The results are sensitive to the value chosen for the duration of each high shear event; Evans took it to be  $2\pi N^{-1}$  but admitted that it could be longer, leading to smaller values of  $K_v$ . His results are thus reasonably consistent with the microstructure estimates, which are more typically less than  $10^{-5} \text{ m}^2 \text{ s}^{-1}$ .

Evans (1982) also makes the interesting suggestion that "...instabilities may be due to increased shear imposed on a variety of different density structures, perhaps finestructure due to other mechanisms ...". It does seem reasonable now to suggest that the spectral region between 0.1 cpm and 1 cpm in the shear spectrum (Figure 4), and in the vertical temperature spectrum (Gregg, 1977), represents finestructure that results from instabilities on the scale of the finestructure, with the internal waves, and associated shear, being limited to wavenumbers less than 0.1 cpm.

**Mixed Region Collapse.** The simple models discussed above assume that any mixing event that creates potential energy is horizontally uniform. It is far more likely, though, that such an event would have a limited horizontal extent (Figure 5) and that the mixed region would tend to collapse laterally, reducing, in the process, the potential energy that has just been created! In the absence of viscous effects the collapse should cease after the mixed region has spread out to its internal Rossby radius of deformation, but viscosity would permit a continued spreading. Is the internal wave energy, which has been transferred by the mixing process to mean potential energy, now being frittered away in Joule heating, with zero net  $K_v$ ?

The potential energy of the three states shown in Figure 5 is easily evaluated. The gain in potential energy, from the uniformly stratified state A to the state B in which the fluid is completely mixed over a depth  $H$  and horizontal scale  $l$ , is

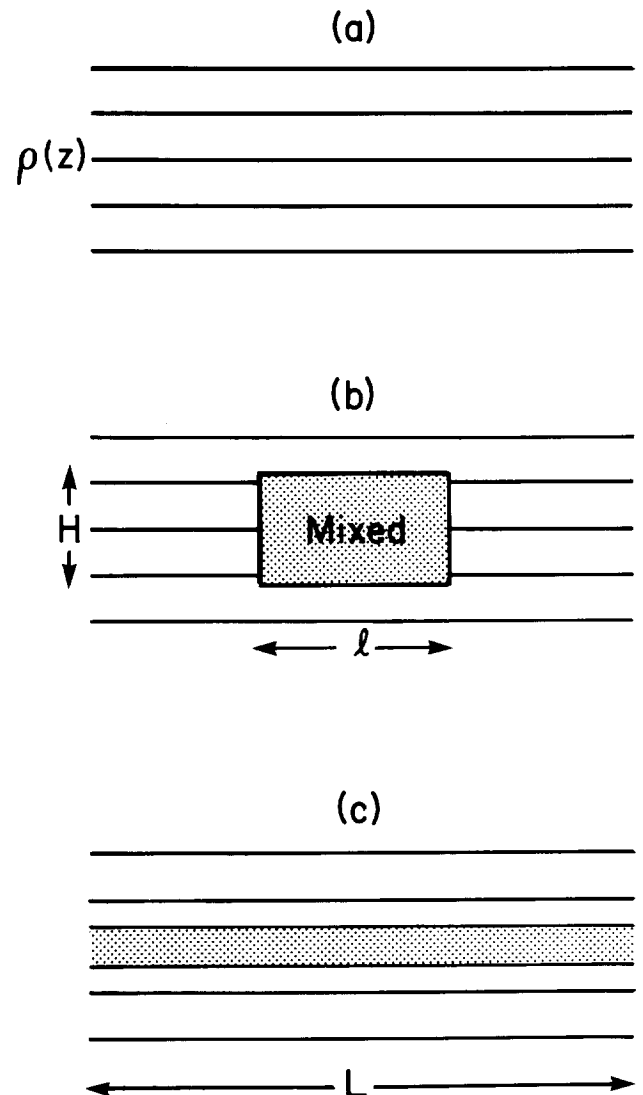

Figure 5. Schematic of a) a linearly stratified ocean which is b) perfectly mixed over a region of height  $H$  and width  $l$ . The mixed region then spreads to c) a distance  $L$ .

$(1/12)\rho_0 N^2 H^3 \lambda$ , with  $\rho_0$  a reference density and  $N$  the Väisälä frequency. If the mixed region now spreads to a horizontal distance  $L$ , state C in Figure 5, the amount of potential energy lost is  $(1/24)\rho_0 N^2 H^3 \lambda (1 - \lambda/L)$ . As  $\lambda/L \rightarrow 0$  this is half the potential energy gain from state A to state B. This possible loss of half the potential energy created in a mixing event means that the kinematic models discussed earlier may overestimate  $K_v$  by a factor of 2 (which is not very important when compared with all the other uncertainties in the models!).

**Dynamical Estimates of Energy Losses from Internal Waves**

Recent years have seen major progress in our understanding of the evolution, through resonant wave-wave interactions, of a typically observed spectrum of oceanic internal waves. After initial calculations by Olbers (1976), McComas and Bretherton (1977) identified three separate classes of interaction which dominate the energy transfers. These, termed elastic scattering, induced diffusion and parametric subharmonic instability, have been discussed extensively by the originators and by subsequent reviewers (e.g. Munk, 1981). Simplified expressions for the energy transfers by the latter two mechanisms have been used by McComas and Müller (1981) in a study of the overall energy balance in a typical internal wave spectrum. As shown in Figure 6 there is a flux of energy from a low-mode (low vertical wavenumber) region, where generation is assumed to occur, to a high-wavenumber region where shear instability can lead to energy dissipation.

As remarked by McComas and Müller (1981), the calculated flows can be consistent with a constant level, constant flux, region of a vertical wavenumber spectrum, but redistribute the energy in a frequency spectrum, primarily to lower frequency. Other interactions may preserve the shape of the frequency spectrum, or possibly wave energy at a frequency

which is approaching  $f$  from above at one latitude can propagate equatorward to a latitude where  $f$  is lower.

The important result of the computations by McComas and Müller is that the time scale for the wave-wave interactions to drain the energy of the low-mode energetic waves is of the order of 50 to 100 days. If this energy fluxes through the spectrum to be dissipated at high wavenumbers, where about 80% is dissipated and 20% appears as potential energy (e.g. Oakey, 1982), we have

$$K_v \rho_0 N^2 \approx 0.2 E / (100 \text{ days}) \quad (4.1)$$

where  $E$  is the local internal wave energy density. This leads to  $K_v$  equal to a few  $\times 10^{-6} \text{ m}^2 \text{ s}^{-1}$ , consistent with the kinematic estimates discussed earlier.

The energy flux to high wavenumbers, and hence into mixing, is shown by McComas and Müller (1981) to be proportional to  $\beta_*^2 N^{-2} E^2$ , where  $\beta_*$  is the vertical wavenumber bandwidth of the energy containing waves. It is still far from clear what determines  $\beta_*$  and  $E$ .

However, it is really rather encouraging that kinematic and dynamic estimates of  $K_v$ , based on the typical internal wave spectrum, agree with each other and with typical results from microstructure measurements. All three approaches give  $K_v$  in the range  $10^{-6}$  to  $10^{-5} \text{ m}^2 \text{ s}^{-1}$ , less than the "classical" value of  $10^{-4} \text{ m}^2 \text{ s}^{-1}$  (Munk, 1966), although it must be remembered that the latter estimate was really for the abyssal ocean, and not for the upper one kilometre or so where most microstructure measurements have been made. The possible dependence of  $K_v$  on depth, and on other environmental parameters, will be discussed later in this paper.

**Universality**

The apparent near-universality of internal wave spectra in time and space has led to all sorts of speculation. An initial temptation was to ascribe it to some sort of "saturation" process, as still espoused by Walter himself (Munk, 1981). The point was made that the energy loss from the internal wave spectrum is probably a very sensitive function of the Richardson number based on the r.m.s. shear, and that this depends on the energy level  $E$  and the high wavenumber cut-off of the spectrum,  $\beta_c$ . Hence, if  $\beta_c$  were fixed, a slight increase in  $E$  would lead to a substantial increase in dissipation. In other words, a big increase in energy input, and hence in the dissipation required, would require only a very slight increase in  $E$ .

The trouble with this argument is that it is hard to think of a physical mechanism that would give a fixed value for  $\beta_c$  (although Munk (1981) tries hard, by hypothesizing a fixed relationship between  $\beta_c$  and the r.m.s. internal wave displacement). It seems far more plausible that the internal wave spectrum would adjust to an increased energy input by increasing both  $E$  and  $\beta_c$ . There is a clear analogy with homogeneous isotropic turbulence which has an inertial subrange  $E(k) \propto \epsilon^{2/3} k^{-5/3}$  and a high wavenumber cut-off  $k_c \propto \epsilon^{1/4} \nu^{-3/4}$  (e.g. Tennekes and Lumley, 1972) for an energy dissipation rate  $\epsilon$ , although the weaker interactions for the low wavenumber internal waves would lead one to expect an energy level proportional to  $\epsilon^{1/2}$  rather than  $\epsilon^{2/3}$  (Cox and Johnson, 1978). It is difficult to predict the dependence on

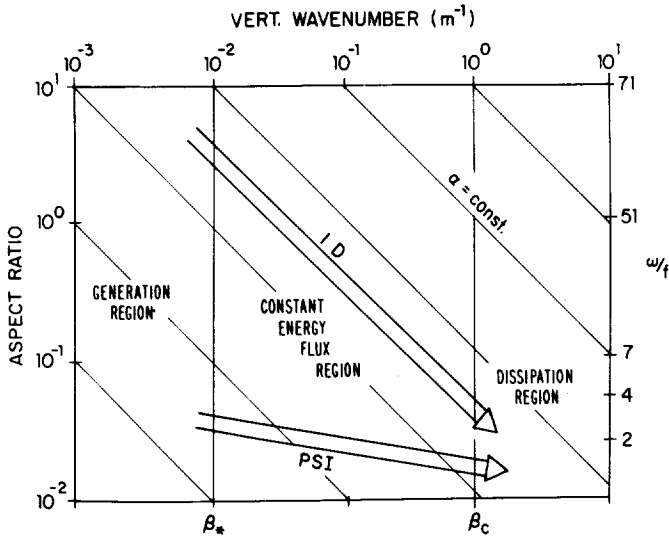

Figure 6. Schematic of the spread of energy, by induced diffusion (ID) and parametric subharmonic instability (PSI), from a generation region at low vertical wavenumbers to a dissipative region at high wavenumbers (from McComas and Müller, 1981).

the energy flux of the more strongly interacting high wavenumbers, and of  $\beta_c$ , but it seems plausible that the energy flux, and hence vertical mixing rate, is determined by interactions at low wavenumbers, and that the nonlinear, high wavenumber, dissipative part of the spectrum sorts itself out to accommodate the flux of energy from low wavenumbers.

Of course, it is also difficult at present to predict how the observed bandwidth,  $\beta_*$ , of the energy-containing waves is determined as a function of the rate of energy input to internal waves, but if we take  $\beta_*$  to be constant then the formulae of McComas and Müller (1981) would lead to  $E \propto \epsilon^{1/2}$ , as mentioned above. Surely the energy input varies very substantially from time to time and place to place; why do we not see this variation reflected in observed energy levels of internal waves?

The answer that seems to be gaining acceptance is connected with the long time constant for the internal wave energy. This, as discussed earlier, is 50 to 100 days according to McComas and Müller (1981), or by taking microstructure estimates of energy losses. While energy input rates may vary greatly in the short term, the average input rate over a timescale of 50 to 100 days will be much smoother, and it is this which will be reflected in the internal wave energy level. Moreover, as emphasized by Cox and Johnson (1978), a patch of high wave energy will tend to spread laterally; we do not really know how far in 100 days because we do not know how quickly wave-wave interactions will remove horizontal anisotropy of the directional spectrum of the waves, but 1,000 km or more seems reasonable (e.g. Garrett and Munk, 1979). Hence the observed internal wave energy levels correspond to a large-scale spatial average, as well as a long time average, of the inputs, and will be much smoother, more universal, than the local inputs.

This view of universality was put forward by Garrett and Munk (1979), following earlier work by Cox and Johnson (1978), and it is unfortunate that Walter has regressed (Munk, 1981) to the less plausible idea of "saturation". But perhaps this represents his final adaptation to North American culture, and he is just "covering his bases".

Walter's footprint is highly visible in another corner of this field. Following up his earlier work with Norman Phillips (Munk and Phillips, 1968) he has shown (Munk, 1980) that a substantial inertial peak in the frequency spectrum of internal waves is a latitudinal turning point effect on a spectrum that is smooth at lower latitudes. Although Fu (1981) has shown that in many regions there is also a locally-generated contribution to the inertial peak, the demonstration that spectra at different latitudes can largely be related through non-dissipative propagation adds weight to the idea that universality results from a smoothing, due to the long time constant of the waves, of spatially and temporally varying inputs.

Internal wave aficionados are still searching for the perfect analogy to this scenario for universality. The best so far is presented by McComas and Müller (1981) who attribute it to Mel Briscoe: "... the internal wave field may be viewed as the thermal energy of a nearly insulated large block of highly conducting metal. As this block is heated by some randomly

distributed Bunsen burners its temperature remains nearly constant."

In summary, one might claim that the following factors are all consistent with each other:

- (i) Microstructure levels in the main thermocline that give  $K_v$  of the order of  $10^{-6}$  to  $10^{-5} \text{ m}^2\text{s}^{-1}$ .
- (ii) Kinematic models of internal wave breaking.
- (iii) Dynamical calculations of the flux, to dissipative high wavenumbers, of internal wave energy.
- (iv) The near-universality of internal wave spectra, with the inertial peak being attributed to a turning point effect.

One might thus claim that Walter's original goal in his internal wave work has been achieved; we do have a rough value for  $K_v$  from internal wave breaking, and it compares rather badly with the "traditional" value of  $10^{-4} \text{ m}^2\text{s}^{-1}$ . However, as will be discussed next, this comparison may not be entirely fair, and the picture itself, of a small  $K_v$  in the thermocline, may be of rather limited value.

### The Depth Dependence of $K_v$

I am told that the U.S. Navy, which, through its Office of Naval Research, has supported Walter for many years and is helping to pay for his birthday party, has some interest in the internal wave field in the upper ocean. I hope that it has found the work of the oceanographic community useful, but not so useful that remote detection of submarines has improved to the point of diminishing the viability of a deterrent scheme based on submarine launched ballistic missiles.

In the long term, though, it is the abyssal internal wave field, and associated mixing, which will be of prime concern to the Navy. The reason for this will be apparent to the perceptive reader of *Oceanus*, in a recent issue of which plans for the seabed disposal of obsolete nuclear submarines are reported (Ryan, 1982). Even with the reactors removed, the submarines will contain substantial amounts of radionuclides, principally Cobalt-60. Any responsible discussion of potential environmental effects of this nuclear waste dumping will require a knowledge of the rate at which contaminants in the deep ocean can disperse and affect man.

As more and more of the U.S. Navy's nuclear submarines are decommissioned, I thus expect increased interest in abyssal mixing rates. I hope that those in the business of measuring microstructure are gearing up to do so in the abyssal ocean. In the next few years I certainly hope to see the Office of Naval Research sponsor a "New Oceanic Microstructure Experiment"; the acronym NOMX should ensure the cooperation of peace-loving oceanographers from other nations.

In the meantime, what do we expect for  $K_v$  below 1 km or so? Munk (1966) has suggested that a value of  $10^{-4} \text{ m}^2\text{s}^{-1}$  is appropriate for the abyssal ocean, excluding the top and bottom kilometre, and this is the sort of value which emerges from other studies in which  $K_v$  is determined by fitting, to data, a model for the mean vertical profile of temperature or another scalar. Notable recent estimates of 3 to  $4 \times 10^{-4} \text{ m}^2\text{s}^{-1}$  for  $K_v$  in the bottom kilometre or so of the Brazil Basin of the South Atlantic have been made by Whitehead and Worthington (1982) and Hogg *et al.* (1982).

Gargett and Holloway (1983) have pointed out that these abyssal values of  $K_v$  are compatible with much smaller values of  $K_v$  in the top kilometre or so of the ocean if  $K_v$  has an inverse dependence on the Väisälä frequency  $N$ , which decreases substantially with depth. They claim that existing data on the energy dissipation rate  $\epsilon$  in the ocean interior suggest  $\epsilon \propto N$ , so that, if  $K_v \rho_0 N^2 = 0.2\epsilon$ , then  $K_v \propto N^{-1}$ .

Unfortunately most of the data on  $\epsilon$ , as on temperature microstructure, are from the upper ocean, so that use of this dependence in the abyssal ocean relies on the extrapolation, to much smaller  $N$ , of a weak, and far from certain, trend. Gargett and Holloway (1983) do produce some theoretical arguments in favour of  $K_v \propto N^{-1}$ , but these, too, are unconvincing.

Can we say anything about the depth-dependence of  $K_v$  by examining the kinematic and dynamic arguments discussed earlier in this paper? The key result from the kinematics was that  $K_v \simeq (1/12)H^2T_e^{-1}$  where  $H$  is the thickness of a typical mixing event and  $T_e$  the time interval between events. Gargett *et al.* (1981) find that the vertical wavenumber spectrum of horizontal shear scales like  $N^2$ , as it should from a WKB theory, but that a high wavenumber transition remains roughly constant instead of scaling like  $N$ . This would give a Richardson number independent of depth, and so supports the idea that energy is being pumped out to dissipative high wavenumbers. However, if the high wavenumber part of the spectrum is depth-independent, then so would be our estimate of the thickness  $H$  of mixing events. The time interval between events,  $T_e$ , is much harder to estimate; it was taken earlier as  $\propto N^{-1/2}$ , giving finally  $K_v \propto N^{1/2}$ . Obtaining  $K_v \propto N^{-1}$  with  $H$  constant would require  $T_e \propto N$ . In principle this is possible, but as we have seen earlier, mixing events would have to occur implausibly often to give  $K_v$  as big as  $10^{-4} \text{ m}^2\text{s}^{-1}$  if they are only a metre or two thick. (This argument is also rather weak, as I'm sure Ann Gargett and Greg Holloway will tell me.)

From a dynamic point of view, McComas and Müller (1981) found an energy flux to high wavenumbers proportional to  $\beta_*^2 N^{-2} E^2$ , where  $\beta_*$  is the bandwidth of the energy containing waves and  $E$  the local energy density. WKB scaling would give  $\beta_*$  and  $E$  both  $\propto N$ , whence  $\epsilon \propto N^2$  and  $K_v$  is independent of  $N$ , but the real depth dependence of  $\beta_*$  is uncertain, and it is not appropriate to consider a local energy balance.

It is clearly difficult to pin down, from existing models, what the  $N$ -dependence of  $K_v$  might be. On the basis of the above discussion  $K_v \propto N^{-1}$  seems unlikely, but it certainly cannot be ruled out. One point worth making is that, for an ocean with  $N$  decreasing exponentially with depth (a reasonable first approximation) and with a given  $K_v$  at the surface, the depth-integrated energy dissipation ( $\int \epsilon dz$  where  $\epsilon = 5K_v \rho_0 N^2$ ) with  $K_v \propto N^{-1}$ , is only twice that for  $K_v$  independent of  $N$ . Either situation could be consistent with a long lifetime for the vertically integrated internal wave energy, and hence with the scenario for universality discussed in the previous section. Another way of expressing this is that a little energy dissipation can produce a lot of mixing in the weakly stratified abyssal ocean.

The discussion so far has been of the general depth dependence of  $K_v$  as a function of  $N$  and nothing else. However, Eriksen (1982) has drawn attention to the enhanced energy, and shear, that results theoretically from reflection of internal waves off a sloping bottom. He finds observational support for this within 100 m or so of the bottom, so that enhanced internal wave breaking and mixing may well occur there. Above 100 m the spectra seem to have relaxed back to a more usual form.

It is also very likely that  $K_v$  fails to follow any simple general law in the region, just below the surface mixed layer, where the internal wave spectrum itself differs from that of the standard models.

### Other Parametric Dependencies

So far I have discussed only the vertical eddy diffusivity  $K_v$ , for mass or a passive scalar, due to internal waves. This is clearly a key parameter for vertical transport even in an ocean that has no motion other than internal waves and small scale turbulence. However,  $K_v$  and the horizontal eddy diffusivity  $K_h$ , as well as the eddy viscosity coefficients  $A_v$  and  $A_h$ , enter the quasi-geostrophic potential vorticity equation satisfied by any mean (sub-inertial) flow (Müller, 1976).

In this paper I have suggested that we may now have a zeroth order value for  $K_v$  in the upper thermocline, but that we do not yet know its depth dependence. Nor, in spite of some microstructure observations in regions of high shear (e.g. Oakey and Elliott, 1977; Crawford and Osborn, 1981) do we have any definite results for the dependence of  $K_v$  on the mean shear.

Young *et al.* (1982) have claimed that shear dispersion by internal waves gives  $K_h \simeq (N^2/f^2)K_v$ , but this formula is not particularly useful if  $K_v$  is unknown.

Müller (1976) proposed a theory of internal wave interactions which led to the large value of  $0.4 \text{ m}^2\text{s}^{-1}$  for  $A_v$ , but Ruddick and Joyce (1979) showed from data (evaluating the vertical eddy momentum flux directly) that  $A_v$  cannot be more than  $0.02 \text{ m}^2\text{s}^{-1}$  in magnitude, and is uncertain in sign.

Brown and Owens (1981) have found weak evidence, from direct measurement of horizontal eddy momentum flux, for a horizontal eddy viscosity  $A_h$  of order  $100 \text{ m}^2\text{s}^{-1}$ , though they admit that this is too large to be compatible with the observed long life of some mesoscale features.

We are still a long way from having adequate answers on the parameterization of internal waves in the ocean, and hark back to simple days in which Walter proposed (Munk and Anderson, 1948) general forms for  $A_v$  and  $K_v$  in terms of basic values together with a dependence on the Richardson number of the mean flow. Thirty-four years later we cannot do much better.

### Conclusions

I have argued that some progress has been made in the last decade towards establishing the vertical eddy diffusivity  $K_v$  that arises from the sporadic breaking of internal waves. Kinematic and dynamic estimates are compatible, and reasonably consistent with microstructure observations and ideas of internal wave universality. However, the depth dependence of  $K_v$ , and the values of other dissipative parameters, remain



very uncertain. Moreover, I have said nothing about other transport mechanisms in the ocean, such as double diffusion, boundary mixing or baroclinic instability.

Walter concluded his own recent review (Munk, 1981), "I shall end up as I started: the connection between internal waves and small scale processes — that is where the key is. I feel that we are close to having these pieces fall into place, and I am uncomfortable with having attempted a survey at this time."

I'm not sure I agree with Walter about the location of the key, but I am uncomfortable about doing anything other than ending up as I started:

Happy Birthday, Walter!

#### References

- Brown, E.B. and W.B. Owens. 1981. Observations of the horizontal interactions between the internal wave field and the mesoscale flow. *J. Phys. Oceanogr.* **11**, 1474.
- Cairns, J.L. 1975. Internal wave measurements from a mid-water float. *J. Geophys. Res.* **80**, 299.
- Cairns, J.L. and G.O. Williams. 1976. Internal wave observations from a mid-water float, Pt. 2. *J. Geophys. Res.* **81**, 1943.
- Cox, C.S. and C.L. Johnson. 1978. Inter-relations of microprocesses, internal waves, and large scale ocean features. (Unpublished manuscript) Scripps Institution of Oceanography.
- Crawford, W.R. and T.R. Osborn. 1981. The control of equatorial ocean currents by turbulent dissipation. *Science* **212**, 539.
- Desaubies, Y. and W.K. Smith. 1982. Statistics of Richardson number and of instability in oceanic internal waves. *J. Phys. Oceanogr.* **12**, 1245.
- Eriksen, C. 1982. Observations of internal wave reflection off sloping bottoms. *J. Geophys. Res.* **87**, 525.
- Evans, D.L. 1982. Observations of small-scale shear and density structure in the ocean. *Deep Sea Res.* **29**, 581.
- Flatté, S.M., R. Dashen, W.H. Munk, K.M. Watson and F. Zachariasen. 1979. *Sound Transmission through a Fluctuating Ocean*, Cambridge University Press, 299 pp.
- Fu, L.-L. 1981. Observations and models of inertial waves in the deep ocean. *Rev. Geophys. and Space Phys.* **19**, 141.
- Gargett, A.E., P.J. Henricks, T.B. Sanford, T.R. Osborn and A.J. Williams, III. 1981. A composite spectrum of vertical shear in the upper ocean. *J. Phys. Oceanogr.* **11**, 1258.
- Gargett, A.E. and G. Holloway. 1983. Dissipation and diffusion by internal wave breaking. *J. Mar. Res.* (in press).
- Garrett, C.J.R. 1979. Mixing in the ocean interior. *Dyn. Atmos. Oceans* **3**, 239.
- Garrett, C.J.R. and W.H. Munk. 1971. The age of the tide and the 'Q' of the oceans. *Deep-Sea Res.* **18**, 493.
- Garrett, C.J.R. and W.H. Munk. 1972. Oceanic mixing by breaking internal waves. *Deep-Sea Res.* **19**, 823.
- Garrett, C.J.R. and W.H. Munk. 1975. Space-time scales of internal waves: a progress report. *J. Geophys. Res.* **80**, 291-297.
- Garrett, C.J.R. and W.H. Munk. 1979. Internal waves in the ocean. *Ann. Rev. Fluid Mech.* **11**, 339.
- Gregg, M.C. 1977. Variations in the intensity of small scale mixing in the main thermocline. *J. Phys. Oceanogr.* **7**, 436.
- Gregg, M.C. 1980. Microstructure patches in the thermocline. *J. Phys. Oceanogr.* **12**, 1245.
- Gregg, M.C. and M.G. Briscoe. 1979. Internal waves, fine-structure, microstructure, and mixing in the ocean. *Rev. Geophys. and Space Phys.* **17**, 1524.
- Hogg, N., P. Biscaye, W. Gardner and W.J. Schmitz Jr. 1982. On the transport and modification of Antarctic Bottom Water in the Vema Channel. *J. Mar. Res.* **40** (Supplement), 231.
- Longuet-Higgins, M.S. 1969. On wave breaking and the equilibrium spectrum of wind-generated waves. *Proc. R. Soc. A* **310**, 151.
- McComas, C.H. and F.P. Bretherton. 1977. Resonant interactions of oceanic internal waves. *J. Geophys. Res.* **82**, 1397.
- McComas, C.H. and P. Müller. 1981. The dynamic balance of internal waves. *J. Phys. Oceanogr.* **11**, 970.
- Müller, P. 1976. On the diffusion of momentum and mass by internal gravity waves. *J. Fluid Mech.* **77**, 789.
- Müller P., D.J. Olbers and J. Willebrand. 1978. The IWEX spectrum. *J. Geophys. Res.* **83**, 479.
- Munk, W.H. 1966. Abyssal recipes. *Deep-Sea Res.* **13**, 707.
- Munk, W.H. and N.A. Phillips. 1968. Coherence and band structure of inertial motion in the sea. *Rev. Geophys.* **6**, 447.
- Munk, W.H. 1980. Internal wave spectra at the buoyancy and inertial frequencies. *J. Phys. Oceanogr.* **10**, 1718.
- Munk, W.H. 1981. Internal waves and small-scale processes. In: *Evolution of Physical Oceanography, Scientific Surveys in Honour of Henry Stommel* (B.A. Warren and C. Wunsch, Eds.) M.I.T. Press, Cambridge, MA, 264-291.
- Munk, W.H. and E.R. Anderson. 1948. Notes on a theory of the thermocline. *J. Mar. Res.* **7**, 276.
- Oakey, N.S. 1982. Determination of the rate of dissipation of turbulent energy from simultaneous temperature and velocity shear microstructure measurements. *J. Phys. Oceanogr.* **12**, 256.

- Oakey, N.S. and J.A. Elliott. 1977. Vertical temperature gradient structure across the Gulf Stream. *J. Geophys. Res.* **82**, 1369.
- Olbers, D.J. 1976. Nonlinear energy transfer and the energy balance of the internal wave field in the deep ocean. *J. Fluid Mech.* **74**, 375.
- Olbers, D.J. 1983. Models of the oceanic internal wave field. *Rev. Geophys. and Space Phys.* **21**, 1567.
- Pinkel, R. 1975. Upper ocean internal wave observations from FLIP. *J. Geophys. Res.* **80**, 3892.
- Ruddick, B.R. and T.M. Joyce. 1979. Observations of interaction between the internal wavefield and low frequency flows in the North Atlantic. *J. Phys. Oceanogr.* **9**, 498.
- Ryan, P.R. 1982. Navy studying the disposal of old nuclear submarines. *Oceanus* **25**, 52.
- Sanford, T.B. 1975. Observations of the vertical structure of internal waves. *J. Geophys. Res.* **80**, 3861.
- Tennekes, H. and J.L. Lumley. 1972. *A First Course in Turbulence*. M.I.T. Press, Cambridge, MA, 300 pp.
- Thorpe, S.A. 1971. Experiments on the instability of stratified shear flows: miscible fluids. *J. Fluid Mech.* **46**, 299.
- Whitehead, J.A. and L.V. Worthington. 1982. The flux and mixing rates of Antarctic Bottom Water within the North Atlantic. *J. Geophys. Res.* **87**, 7903.
- Wunsch, C. and S. Webb. 1979. The climatology of deep ocean internal waves. *J. Phys. Oceanogr.* **9**, 235.
- Young, W.R., P.B. Rhines and C.J.R. Garrett. 1982. Shear-flow dispersion, internal waves and horizontal mixing in the ocean. *J. Phys. Oceanogr.* **12**, 515.

# ACOUSTIC TOMOGRAPHY AND OTHER ANSWERS

Carl Wunsch

*Departments of Earth & Planetary Sciences  
and Meteorology & Physical Oceanography  
Massachusetts Institute of Technology  
Cambridge, Massachusetts 02139*

"I do not spend much time in polishing lectures. The excuse is that ... students learn more if they participate in halting derivations and have the joy of pointing out blunders, than if they are handed the subject on a silver platter."

Walter Munk

"... definitive papers are usually written when a subject is no longer interesting. If one wishes to have a maximum impact on the rate of learning, then one needs to stick one's neck out at an earlier time. Surely those who first pose a pertinent problem should be given some of the credit, and not just criticized for having failed to provide the final answer."

Walter Munk

## Introduction

I want to discuss the way in which oceanographers go about observing the ocean. The ocean is so incomprehensibly large, it is helpful to pretend for the moment that we are experimentalists who have made a model ocean, which sits in our laboratory. We scale the approximately 20,000 km horizontal dimension down to something manageable, about 1 m across, and the full 5 km depth also comes down to about 1 m vertically as shown in Figure 1 (to maintain the aspect ratio, the vertical dimension should be about .03 mm, but

then our laboratory "ocean" would be difficult to draw and close attention to details is not the order of business here). Some bags of salt are mixed in at the beginning and we suppose the entire apparatus is rotating.

To simulate the effects of solar heating, we have a heat lamp (Figure 2), and for the complexities of the wind forcing, we have a great many small propellers (Figure 3) blowing on the surface each controlled independently by a computer program giving them a complex time and spatial variability. To simulate the formation of ice at high latitudes, we

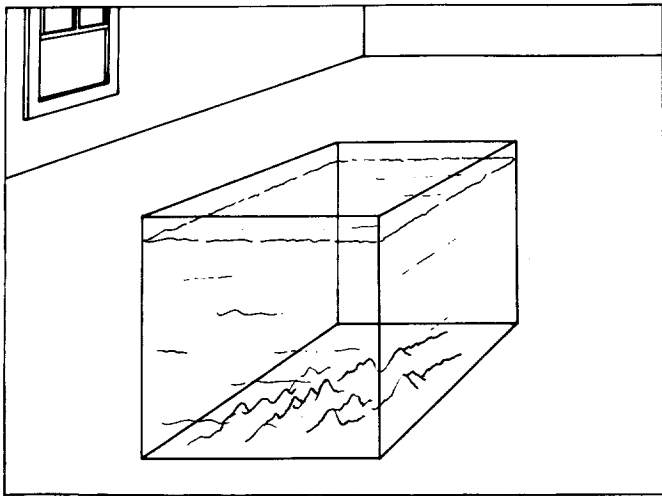

Figure 1. A laboratory "ocean" in which we construct a metaphor of sampling schemes applied to the real ocean. One must imagine this box has a scale of about 1 m, that it is filled with salty fluid and is rotating at a high rate.

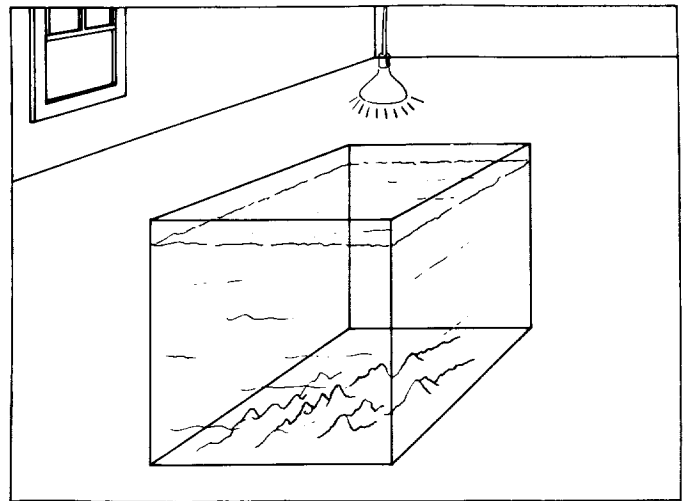

Figure 2. Heat lamp with somewhat uncertain thermostatic control that warms the surface of the laboratory ocean. The true annual cycle becomes a somewhat irregular 3.5 day laboratory cycle.

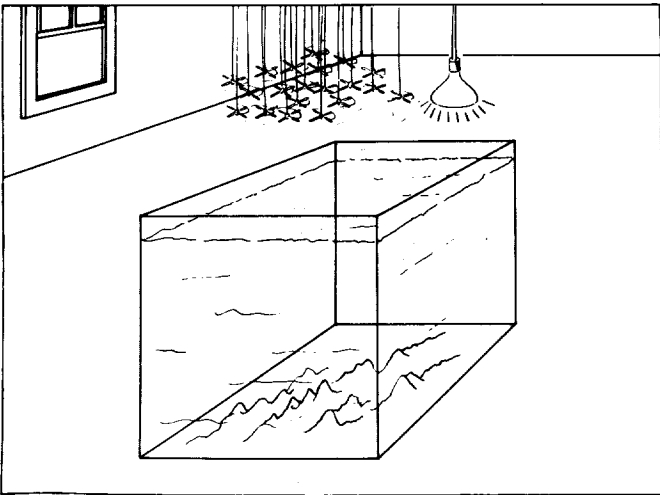

Figure 3. Laboratory winds are generated by a very large number of nearly independently fluctuating propellers controlled by a now-lost computer program.

have a small machine for that (Figure 4). The thermostat is somewhat faulty and the heat lamp tends unpredictably to give more or less radiation. The graduate student who set up the entire apparatus, and the only one who really understands the microprocessor controlling the "winds", heat lamp and ice machine, left at the beginning of the year, to take a job with an oil company. He is now somewhere in Asia on an oil rig, and totally unreachable. Often during the night, the sprinkler system malfunctions (Figure 5) upsetting the salt distribution in the "ocean", but we have no way of knowing when this occurs.

The model ocean has a somewhat complicated bottom topography, also generated with some now unknown formula by the departed graduate student. At one point during our experiments, a visitor from the U.S. Navy comes and spends a great deal of time measuring the bottom topography in one

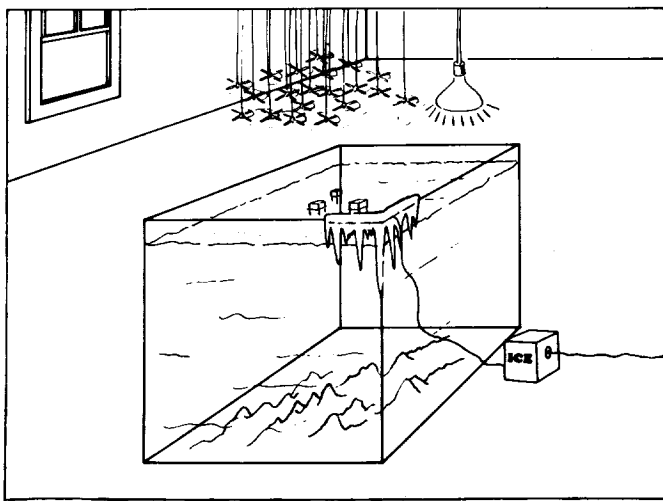

Figure 4. At "high" latitudes we need some ice making.

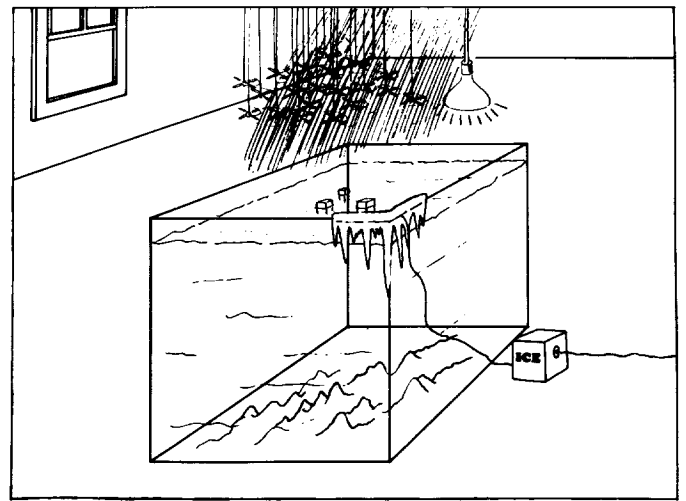

Figure 5. Late at night when no one is around to notice, the sprinkler system in the laboratory tends to malfunction, sometimes upsetting the salt balance of our model in unknown ways.

small corner (the North Atlantic) of the ocean. But when he leaves, he takes all the measurements with him because he distrusts another visitor to the lab (a Russian), who might have taken unfair advantage of all his labors.

It is now New Year's Eve, and having had a few celebratory drinks, we are looking back over our efforts, in order to write a progress report to the various funding agencies that have been intermittently supporting the work. One must imagine that the entire history of approximately 100 years of oceanography is condensed into the one year of laboratory time. Last January, corresponding to the *Challenger* expedition of 1872+, we spent a week making spot measurements of temperature and salinity in our ocean. Exhausted by our efforts, we make only a few random meanderings through the model in the next six months. Around June, a German colleague comes and makes a few temperature and salinity measurements in the "South Atlantic" section of our ocean. All work then ceases for several weeks owing to a gap in our funding and student riots (WW-II?).

For three days in late October we make a few more temperature and salinity sections (the IGY-?). In late October, a drunken janitor accidentally drops some radioactive rubbish into the tank. About two weeks later, we figured out that radioactivity is starting to spread around the tank and we decide we might learn something from it if we can reconstruct exactly where and how much the janitor dropped in, and if we can measure it before it all decays (which it is doing by  $e^{-1}$  every two weeks).

In early December, owing to some new instruments purchased at vast expense and put out in one corner of the box for a day or two, we suddenly discover that the fluid flow is actually turbulent, with random changes occurring about every  $\frac{1}{2}$  cm horizontally and 10 cm vertically. In a fit of great enthusiasm, we pour most of our resources into trying to understand what is happening — so we do "MODE" for two days in a little vertical cylinder about  $\frac{1}{2}$  cm on a side.

While all this is going on, our visiting theoretician is sitting in the corner churning out theories about what is meant to be going on in the box (Figure 6) — theories of dubious validity (Figure 7). Because of our strange government, money

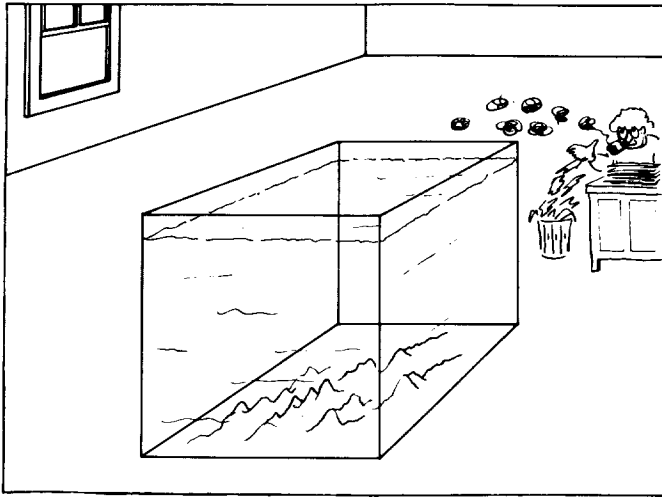

Figure 6. In one corner of our laboratory sits the group theoretician who spends his time concocting theories (Figure 7) of what ought to be going on in the tank, although he tends to avoid paying much attention to what the experimentalists are saying.

arrives in bundles every three days (Figure 8), but only after we spend a few hours a day pleading for funds. Finally, Figure 9, we are beginning to suspect now that a whole year has passed, and that despite the New Year's glow, perhaps our observational techniques are somewhat too crude for the job at hand. We are also a little disturbed that on Christmas Day we found out that the plumber's helper who helped set up the tank was a bit of a practical joker, and he had rigged the pipes so that hot water had been injected into the bottom of the tank at random points all this time, and we didn't know it.

As a metaphor for our ability to observe what is happening in the real ocean, the cartoon sketched above is perhaps somewhat exaggerated — but I think not very much so. Oceanographers of the past 100 years have done a remarkable job of making do with the tools at hand. But faced with the even simpler problem of working with a laboratory tank like that depicted in Figure 1, and with some sense of what was really going on in the fluid, no self-respecting experimentalist would pretend that he had even begun the proper job of observation. He might think he was now ready to begin.

### What Do We Want?

We are faced with a global, turbulent, fluid in which many of the important processes occur over months to decades. The ocean is at least as complicated as the atmosphere, and although they are always complaining bitterly about the poor state of their observations, we can look at the sort of thing meteorologists have available to get some idea of what is necessary. Figure 10 depicts the reporting synoptic network (radiosondes and surface observations every 6 or 12 hours) in one of the more poorly covered parts of the world. Many scales are covered — from the synoptic up to the global; the

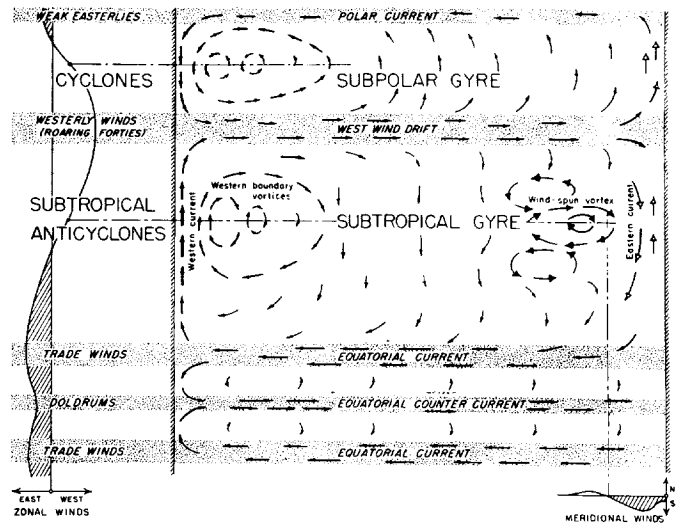

Figure 7. Theoreticians view of the ocean circulation (Munk, 1950).

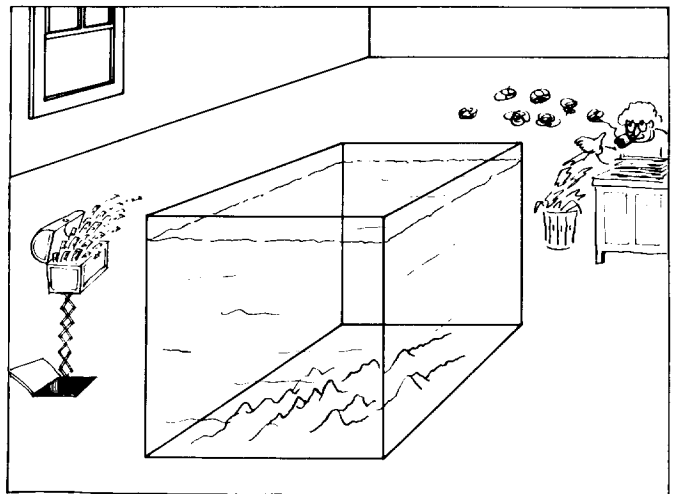

Figure 8. Money for support of the laboratory tends to arrive through strange routes and at irregular intervals after much time is spent looking for it.

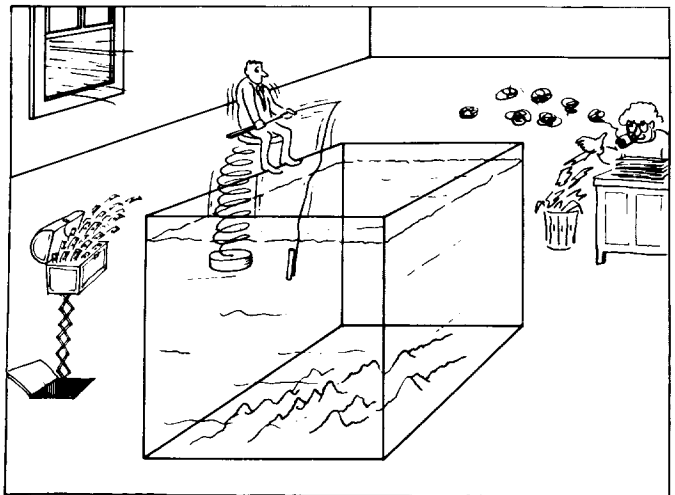

Figure 9. The laboratory observer finds often that his instrument system leads to seasickness.

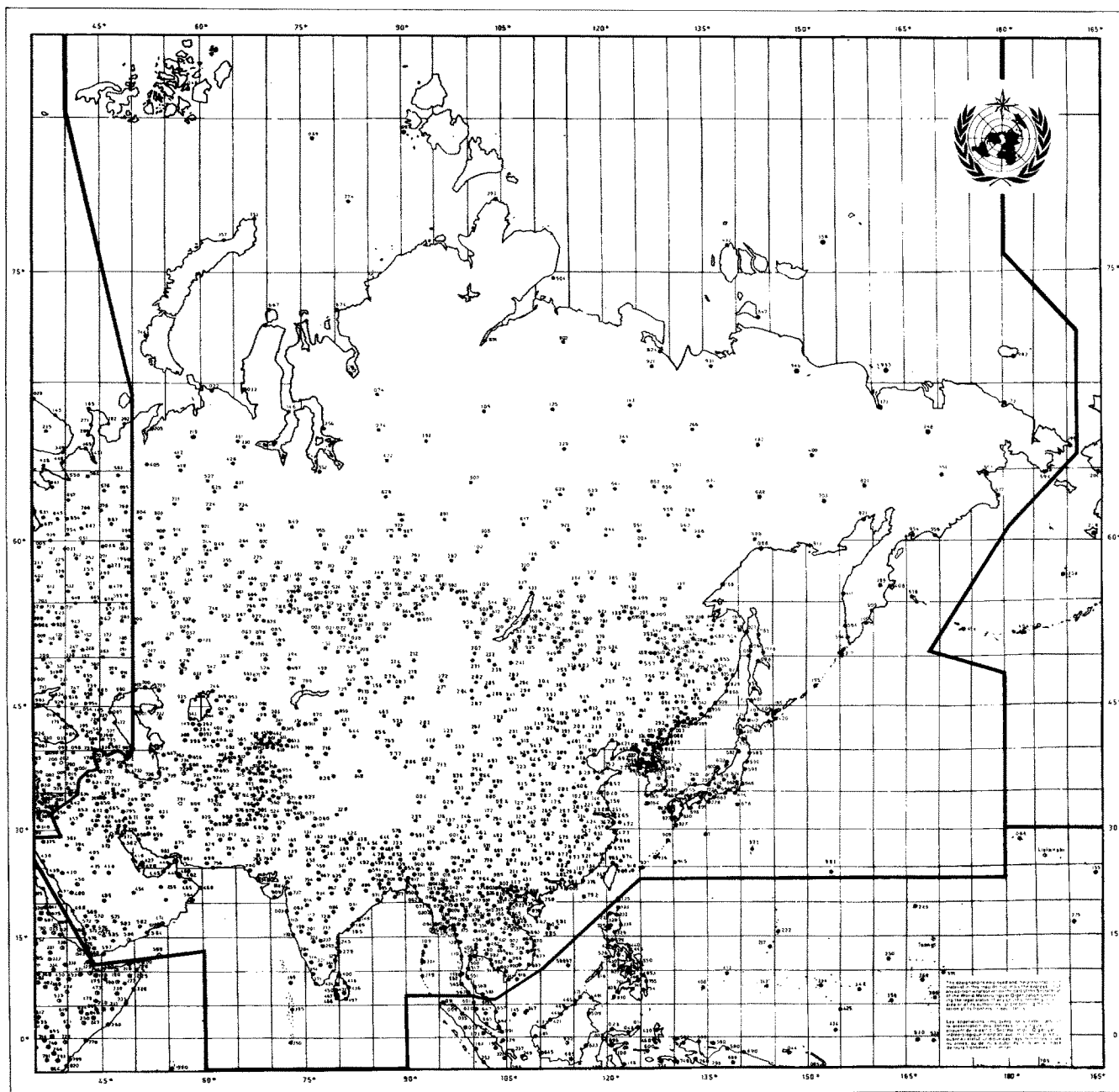

Figure 10. Meteorological network in eastern Asia, one of the less-well covered regions of the globe (from World Meteorological Organization, 1979). Oceanographers do not have coverage anything remotely like this even in the best sampled parts of the ocean.

network is maintained indefinitely. Knowledge of atmospheric climate is a by-product of the accumulated statistics for weather forecasting. Figure 11 is a satellite image of an entire hemisphere. Such pictures are available several times each day for the entire globe. From these and other sources, meteorologists can construct charts such as the one shown in Figure 12 and follow the evolution of the large-scale structure of the atmosphere from day-to-day — and hour-to-hour in some locations. Do oceanographers need any less information in order to answer the questions they can pose about the ocean?

Oceanographers of the past decade or two have tended to focus their attention on what one might identify as "regional" observation programs. Turning away somewhat from the previous, post-*Challenger*, studies which came to be regarded as exploratory and somewhat non-scientific, towards more "process-oriented" programs, we have had MODE and successors, the upwelling observations, various equatorial programs, and many others. This work was entirely sensible — it was the way the field could progress most rapidly — but in the process some sight was lost of the global nature of the



*Figure 11. Satellite picture (Meteosat; from Morel et al., 1978) showing an entire hemisphere of the atmosphere. Such pictures are available globally to meteorologists several times per day.*

underlying science. No meteorologist would consider doing a regional study without the means to understand what was happening on the larger scale around him; MONEX was embedded in the FGGE program — the FGGE program was not built around MONEX or other regional foci. Can oceanographers escape the need to define the fluid on the largest scales?

#### **What should we do?**

We need a global observation system. At this point, it is useful to introduce the following excerpted quotation:

*The Problem: Large-Scale [Oceanic] Motions Imbalance Between Theory and Observation*

The second World War marked a turning point in the science of [oceanography]. It was only with the aid of indirect inferences from ... observations ... that a few gifted individuals had succeeded in identifying the principal features of the

[ocean] and in establishing a rudimentary theory of its three-dimensional motion. However, this theory was too idealized to have any predictive power and therefore could not serve as a guide to the selection of observations. [After the war] ... improved knowledge of the [ocean] lead to the construction of more realistic physical models,

and numerical integrations of the governing equations permitted direct comparisons with reality. ... [Oceanography] had at least become a mature science, a science in which theory and observation exist on an equal footing.

We are now faced with an imbalance in the opposite direction. Advances in data-processing

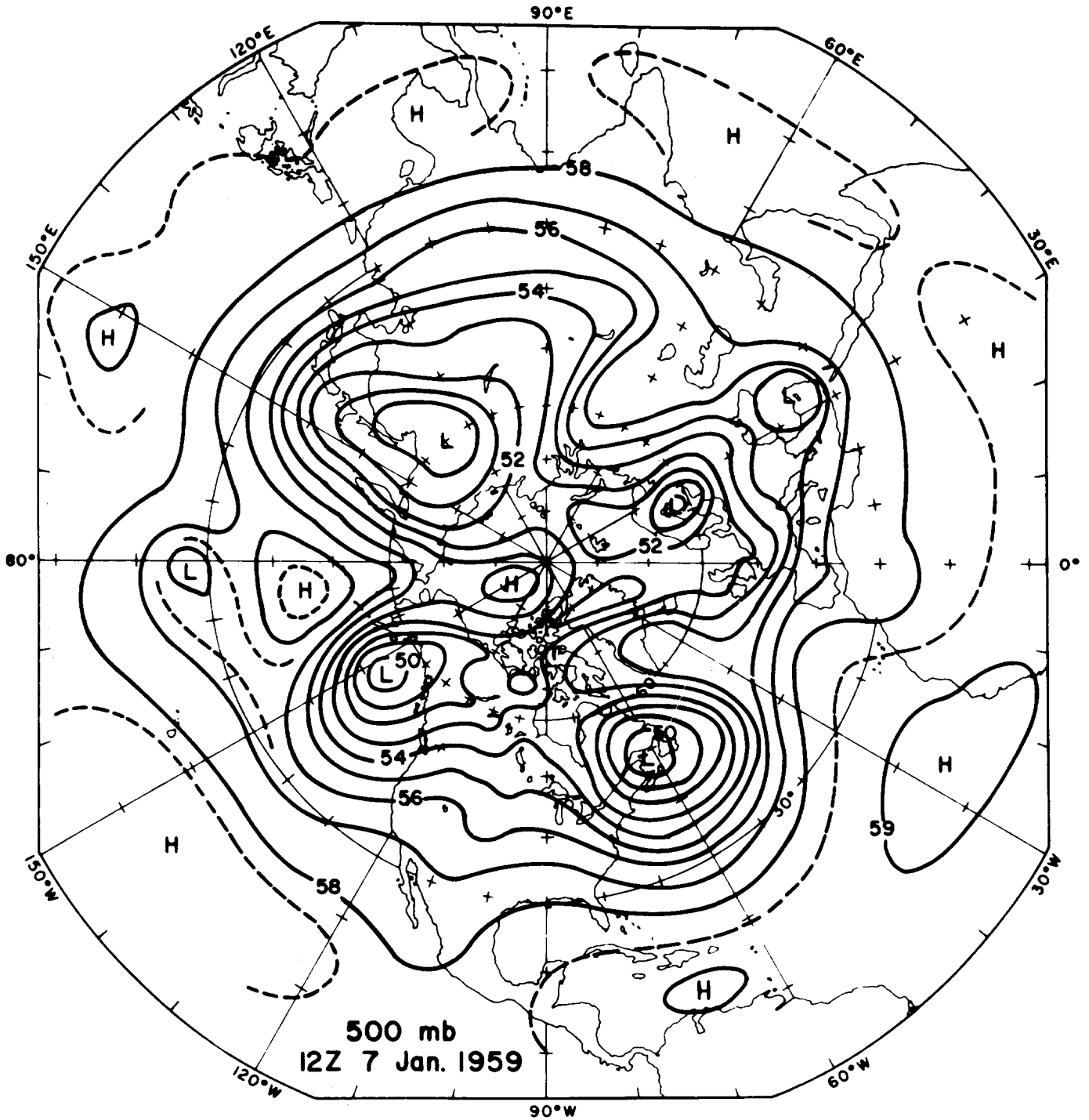

Figure 12. Hemispheric map (taken from Palmén and Newton, 1969, after a U.S. Weather Bureau analysis) of pressure. Meteorologists can construct such maps at least every 12 hours from their global observation system.



technology and physical understanding have so extended the scope and complexity of the numerical models that can be treated that it is becoming possible to deal with the circulation of the [ocean] as a whole. ... But such investigations are in danger of becoming mere academic exercises, due to the lack of observations to supply the initial conditions and to check the calculations.

#### *Need for Global Observations*

The large-scale elements of the [ocean] circulation are so strongly coupled in space and time that they can be understood only in combination. Hence if appreciable advances are to be made in our understanding of the general circulation ... the [ocean] must be measured on a global scale. If expense and manpower were no consideration, one would surely advocate the immediate extension of the present ... observing network to the entire globe. But to do so by conventional means would involve a prohibitive increase in costs. ... Such costs are not likely to be borne by any country or combination of countries until it becomes evident that they would be offset by the economic benefits to be derived. ... One is thus in a dilemma: until global ... data for scientific studies and numerical ... experimentation become available, no significant gain can be made in our understanding of the global circulation ... and until such gains are made we are not likely to be supplied with the additional observations.

The [ocean] is a complex turbulent fluid containing eddies of many scales. The scientific problems which give rise to the need for a global observation system of the kind here contemplated are based on the hypothesis that the [ocean] is a determinate or near-determinate system on some macro-scale. ... A second fundamental concept that underlies the need for a global observation system is that the macroscale circulations of the [ocean] constitute a single, self-contained physical system with all its parts in mutual interaction. ...

Truly global data gathered for even a limited period of time would constitute a treasure house of scientific information that could be used over and over again for years of scientific study. Such data would not collect dust in the archives, which has all too often been the fate of the fragmentary observations taken in the International Years or in regional studies. The reason is that global measurements define the physical system, whereas the fragmentary or regional studies do not. Regional studies of phenomena on a synoptic scale generally fail to determine the vertical and horizontal boundary fluxes, and as a consequence all but the smallest scales of motion remain physically undefined. It is as if one were

to try to account for the fluid motions in a rotating heated tank by measuring the motions in only a small part and neglecting altogether to measure the heat flux through the boundaries.

The principal conclusions and recommendations that have emerged from our study may be summarized as follows:

1. A major international research and development program directed toward an experiment to measure the large-scale motions of the entire [ocean] for a limited period of time is fully justified by scientific potential and technological capabilities.

...

3. The principal objective to be achieved by the global observation experiment is the definition of the entire [ocean] as a single physical entity. The integrity of this concept should not be lost through any consideration of expediency or through diversion of the observational system to other purposes.

This quotation is taken from the report of a National Academy of Sciences (1966) Panel chaired by the late Professor Jule G. Charney. It was an important planning document that led directly to the carrying out of the First Garp Global Experiment (FGGE) at the end of the 1970's. In this extract, I changed "atmosphere" to "ocean", etc. but with that change, their document is also a compelling argument for the need for an oceanic global observation system. The planners of FGGE had specific technical capabilities in mind (e.g. satellites, balloons, large computers, etc.). What, if anything, could oceanographers do?

#### **What Can We Do?**

I believe that oceanographers now have, or soon will have, the capability for making global observations of the sea, and without bankrupting national governments in the process. In order to show that this proposition is true, I will focus upon two new technologies with which I am familiar — ocean acoustic tomography, and satellite altimetry. These are two of many new techniques — and I do not wish to imply that they are a unique or even the correct answer to the problem posed — merely that they are reasonably well understood and by themselves could probably take us a long way down the road we need to go.

#### **Acoustic tomography**

Tomography is a concept best known from medicine, but its roots are very old. One of the major applications from which medical practice stems is in radio astronomy and related fields (see Herman, 1979, 1980). Bracewell and Riddle (1967) is one of the important early discussions of the underlying mathematical problem. Most studies of tomographic techniques however, trace their antecedents back to a paper of Radon (1917; the first page of this paper is displayed in Figure 13; the entire paper is reproduced as an Appendix to the book by Helgason, 1980). Radon provides little insight into the motivation for the work he describes, beyond a vague reference to Newtonian potentials. In any event the "Radon transform" provides the basic mathematical justification for

SITZUNG VOM 30. APRIL 1917.

Über die Bestimmung von Funktionen durch ihre Integralwerte längs gewisser Mannigfaltigkeiten.

Von  
JOHANN RADON.

Integriert man eine geeigneten Regularitätsbedingungen unterworfenen Funktion zweier Veränderlichen  $x, y$  — eine *Punktfunktion*  $f(P)$  in der Ebene — längs einer beliebigen Geraden  $g$ , so erhält man in den Integralwerten  $F(g)$  eine *Geradenfunktion*. Das in Abschnitt A vorliegender Abhandlung gelöste Problem ist die Umkehrung dieser linearen Funktionaltransformation, d. h. es werden folgende Fragen beantwortet: kann jede, geeigneten Regularitätsbedingungen genügende Geradenfunktion auf diese Weise entstanden gedacht werden? Wenn ja, ist dann  $f$  durch  $F$  eindeutig bestimmt und wie kann es ermittelt werden?

Im Abschnitte B gelangt das dazu in gewisser Hinsicht duale Problem der Bestimmung einer Geradenfunktion  $F(g)$  aus ihren Punktmittelwerten  $f(P)$  zur Lösung.

Schließlich werden im Abschnitte C gewisse Verallgemeinerungen kurz besprochen, zu denen insbesondere die Betrachtung nichteuklidischer Mannigfaltigkeiten sowie höherer Räume Anlaß gibt.

Die Behandlung dieser an sich interessanten Probleme gewinnt ein erhöhtes Interesse durch die zahlreichen Beziehungen, die zwischen diesem Gegenstande und der Theorie des logarithmischen und Newtonschen Potentials bestehen, auf die an den bezüglichen Stellen zu verweisen sein wird.

Figure 13. First page of the important paper of Radon (1917) whose transform underlies much of medical and other tomography.

much of which came later although one sometimes must look very hard to see the direct connections.

It is in medical applications however where tomography has become best known (and the only area of application known to me where a lot of money has been made). Figure 14a shows a medical "CAT" (for either "computer assisted tomography" or "computed axial tomography") instrument. Figure 14b shows the basic geometry and Figure 15, an actual tomogram of the thorax of a dog (from Brooks and DiChiro, 1976); the reviews of Herman (1979, 1980) are excellent introductions both to the history of tomography and the great variety of mathematical techniques now used for the analysis.

In medical applications, the scanning energy is in the form of X-rays and one determines absorption along the line from transmitter to receiver; in radio astronomy it is electromagnetic radiation of various sorts. Ocean tomography relies upon sound transmission.

Ocean acoustic tomography was concocted in the summer of 1977 at the Bishop's School in La Jolla by Walter Munk and myself. We were really being paid to think about how to find submarines, but were distracted onto the far more interesting (and useful) problem of observing and measuring the ocean (I never did contribute anything to the submarine problem). Walter had been working for some years on using sound as a tool for understanding the ocean — primarily at short ranges with an emphasis on internal wave effects (e.g. Flatté, *et al.*, 1979), I knew nothing about acoustics, but had

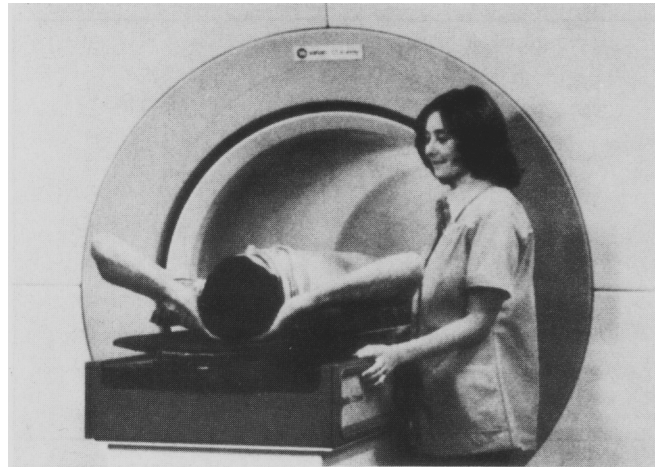

Figure 14a. Medical CAT scanner (from Swindell and Barrett, 1977).

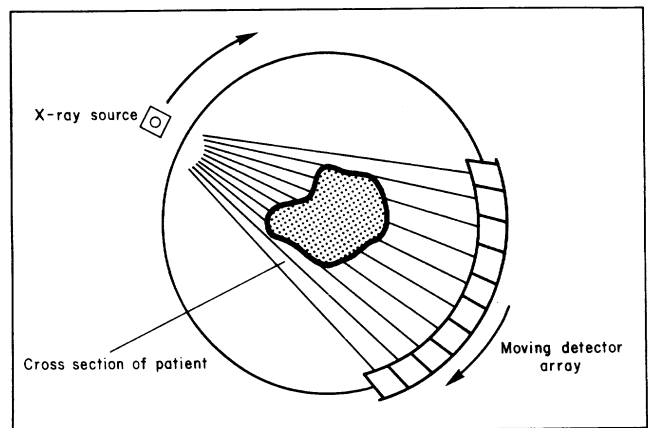

Figure 14b. The geometry of a CAT scan (Swindell and Barrett, 1977) in which X-rays are used to reconstruct the interior of a patient.

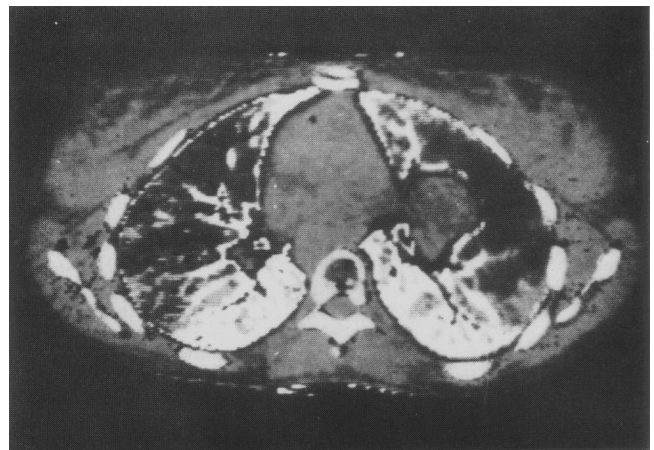

Figure 15. CAT scan of the thorax of a dog (Brooks and DiChiro, 1976).

for some time been trying to apply "inverse methods" to oceanic hydrographic data (e.g. Wunsch, 1977, 1978). After a few days of exchanging news about what we had each been doing the past several months, and after some desultory conversations about sounds emitted by submarines, Walter and I soon realized that the combination of what he knew

about acoustics with what I knew about inverse theory might be a potent way to observe the ocean on very large scales. I believe that it was Dick Garwin (with whom we ultimately wrote the first outline description of the technique (Garwin, Munk and Wunsch, 1978)) who pointed out to us that we had re-invented tomography.

The suggestion that one might actually use sound propagation as a useful observational tool was taken up by ourselves and our colleagues (Spindel and Spiesberger, 1981, Spiesberger *et al.*, 1980). My message here is mostly that the method works. Figure 16 is taken from a thesis of Cornuelle (1983), showing the time evolution of the mesoscale field in a (300 km x 300 km) region of the western North Atlantic, determined from purely acoustic measurements.

Tomographic techniques have many virtues; from the point of view of someone interested in global scale observations of the ocean, two are of primary interest: 1) the observations are integrating; they automatically give us long space and time observations — something prohibitively expensive with conventional point moorings. 2) The number of acoustic paths (and hence information) grows as  $N^2$  where  $N$  is the number of acoustic moorings. With conventional instruments, information is added only as  $N$  (both these statements are only approximately true, needing some qualifications). If one can do "reciprocal" or "velocity" tomography (see Munk and Wunsch, 1982) then we open the possibility for measuring ocean basin scale heat content, vorticity, potential vorticity, upwelling, etc. Figure 17 displays a 15 mooring array in the North Atlantic — more or less arbitrarily placed — that one might contemplate deploying in the next few years. The formulae of Longuet-Higgins (1982) show that 15 moorings give 105 paths and 455 triangles of which 92 are independent. Fifteen moorings is not a large number in modern terms (the MODE Group (1978) deployed 26 moorings in 1973). If the engineering can be done (and we believe it can), then at least ocean basin scale measurements become possible for the first time. If we can learn how to send data back through the sea surface to satellites, we have a way of measuring the *interior* structure of the ocean over very large scales for the requisite long periods of time.

### Altimeters

Satellite altimeters are another recent remarkable technical development. Figure 18 shows the ground coverage by the short-lived (3 months) Seasat altimeter. There are many things that have been done with the dataset from this satellite, short as the record is. Figure 19a shows (Tai and Wunsch, 1983) the long wavelength components of the sea surface topography of the Pacific Ocean determined by Seasat, and Figure 19b displays the Wyrтки (1975) dynamic topography surface seen through the same low-pass filter applied to the satellite data. Tai and I believe that there is a remarkable resemblance — especially keeping in mind that the hydrographic surface cannot be regarded as "truth", representing a highly inhomogeneous average of 70 years of data relative to an arbitrary reference level. (Klaus Wyrтки does not entirely approve of what we did to his surface.) On another scale, Figure 20 shows the global variability (over

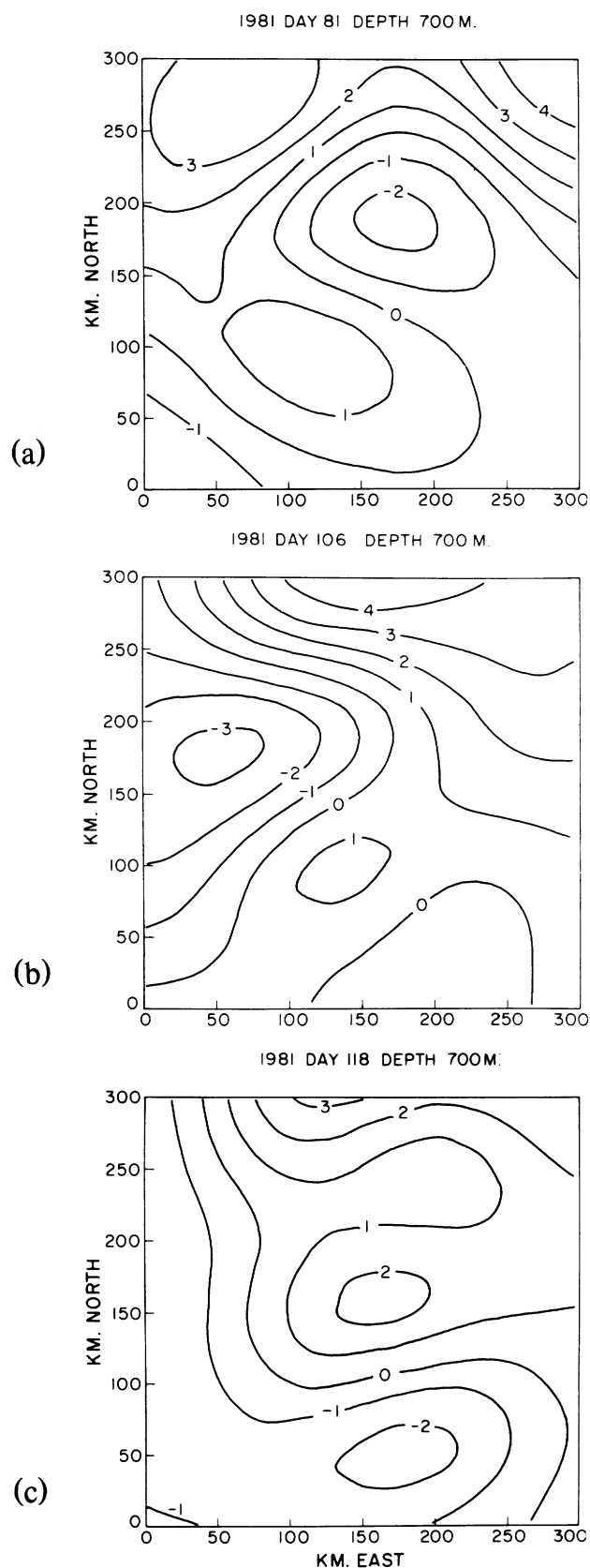

Figure 16a-c. Tomographic maps of a 300 km x 300 km of ocean based upon an acoustic method (Munk and Wunsch, 1979; *The Ocean Acoustic Tomography Group*, 1982; Cornuelle, 1983).

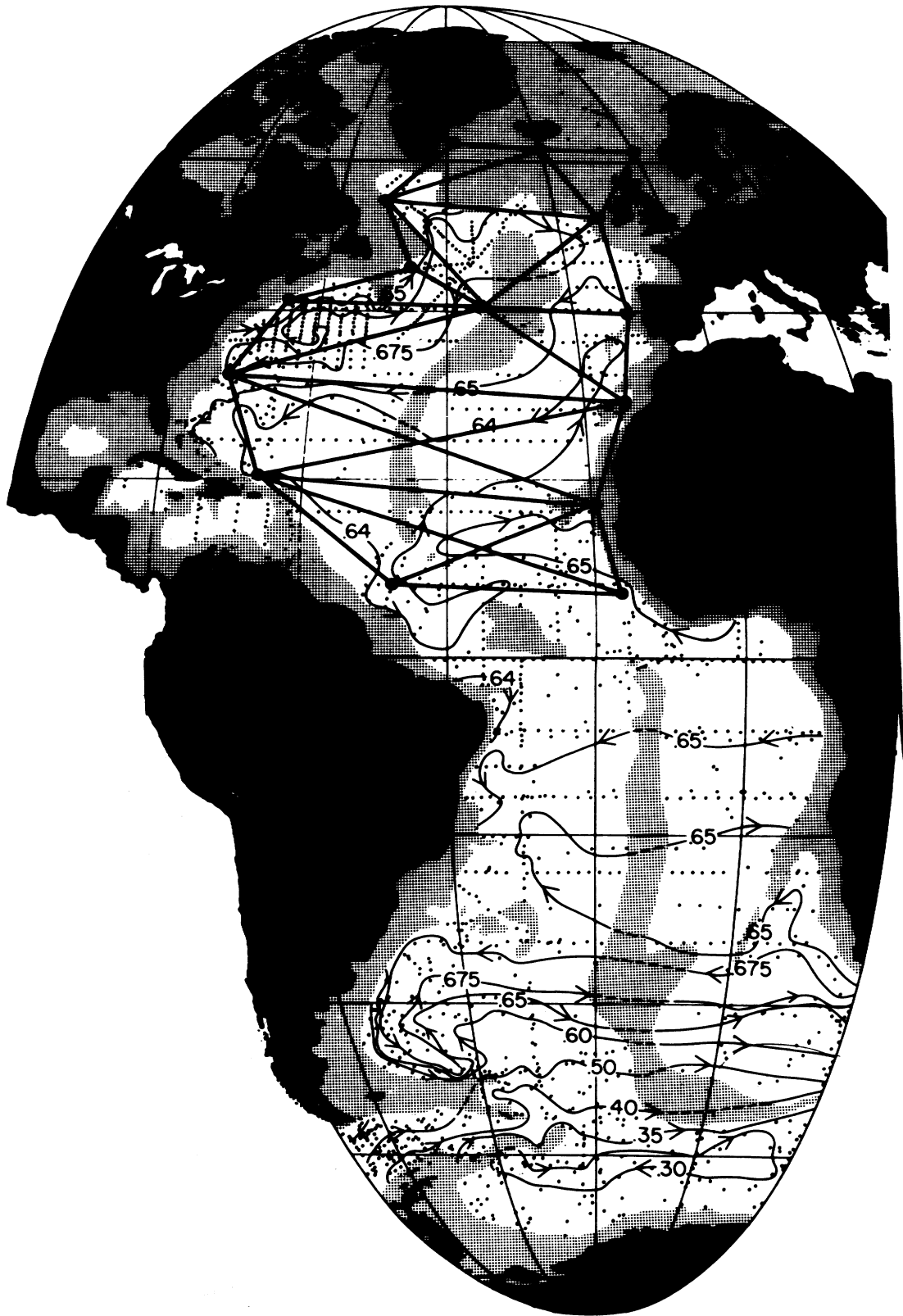

Figure 17. Conceivable basin-scale tomographic array suitable for measuring the entire North Atlantic (from Munk and Wunsch, 1982).

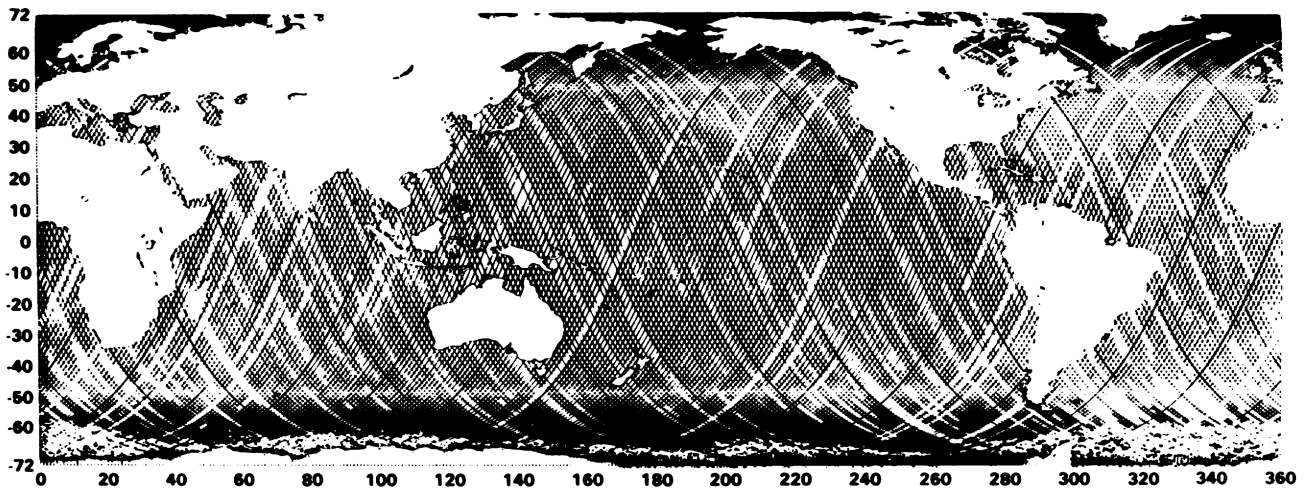

Figure 18. Coverage from the Seasat altimeter during the period of time September-October 1978.

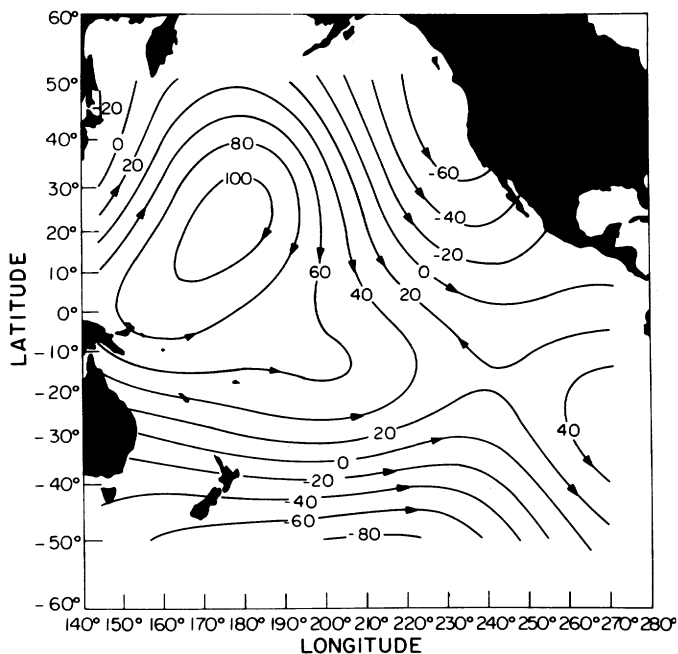

Figure 19a. Absolute dynamic topography of the Pacific Ocean as determined from Seasat altimetry and the GEM-9 geoid. The field is seen through a spatial low-pass filter (from Tai and Wunsch, 1983).

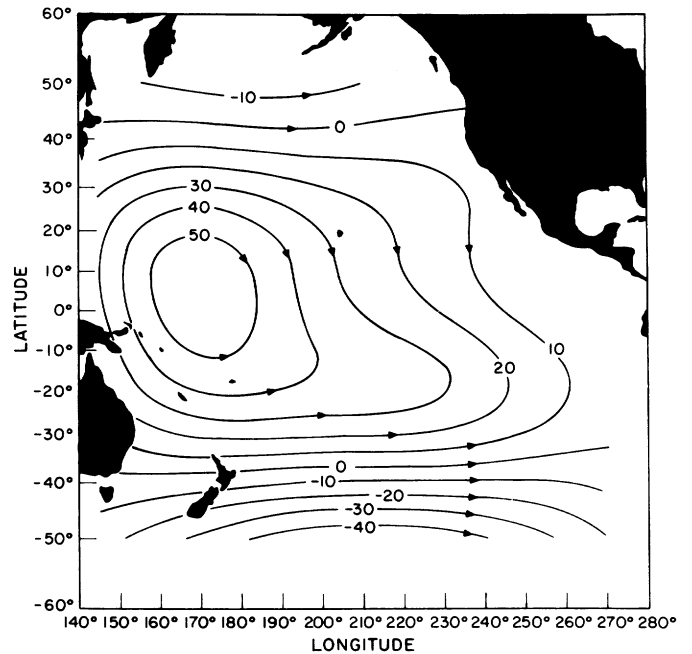

Figure 19b. The dynamic topography of the Pacific Ocean as determined by Wyrki (1975) from 70 years of shipboard hydrography, but seen through the same filter used to construct Figure 19a (Tai and Wunsch, 1983).

three months) computed from this same data by (Cheney, Marsh and Grano, 1981) and Figure 21 (from Fu, 1983) shows that one can compute frequency/wavenumber spectra from altimeters.

The chief virtue of satellite observations is that the oceanic coverage is *global*. If we can fly the Topex altimetric satellite (Topex Science Working Group, 1981) then every 10 days we can make maps of the sea surface topography with a global accuracy of a few centimeters — track the month-to-month changes in circulation, the annual and interannual variability and generally have a grip for the first time on what the ocean is doing beyond purely regional scales.

An apparent liability of satellites is that they measure phenomena occurring only at the sea surface — owing to the opacity of seawater to electromagnetic radiation — forcing us to acoustical techniques to probe the interior. The air-sea interface is no doubt one of the most complex fluid systems in nature and most properties of the surface visible from space — temperature, color, roughness, etc. are not easily interpreted or converted into quantitative statements about oceanic flows. I think that it is fair to say that while infrared temperatures and color scanners have produced spectacular pictures for textbooks, they have not (with a few notable exceptions) contributed much directly to quantitative

MESOSCALE SEA HEIGHT VARIABILITY FROM SEASAT COLLINEAR ALTIMETER DATA

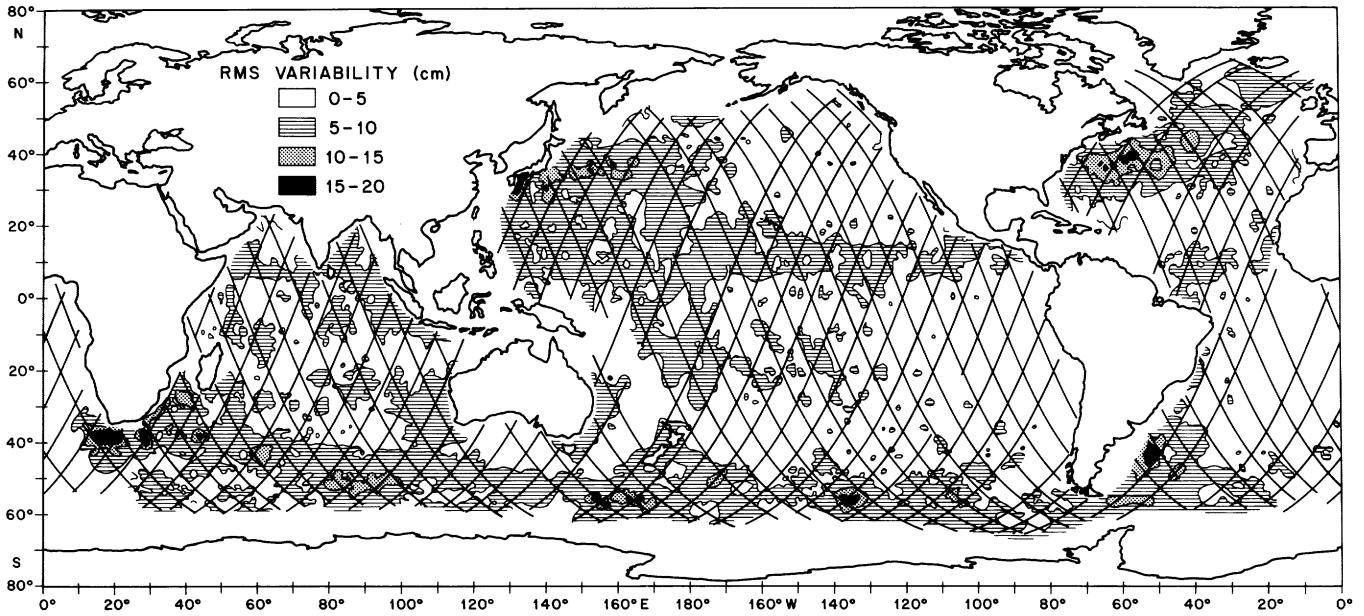

Figure 20. Global chart of energy in mesoscale variability as determined from satellite altimetry (Cheney et al., 1981).

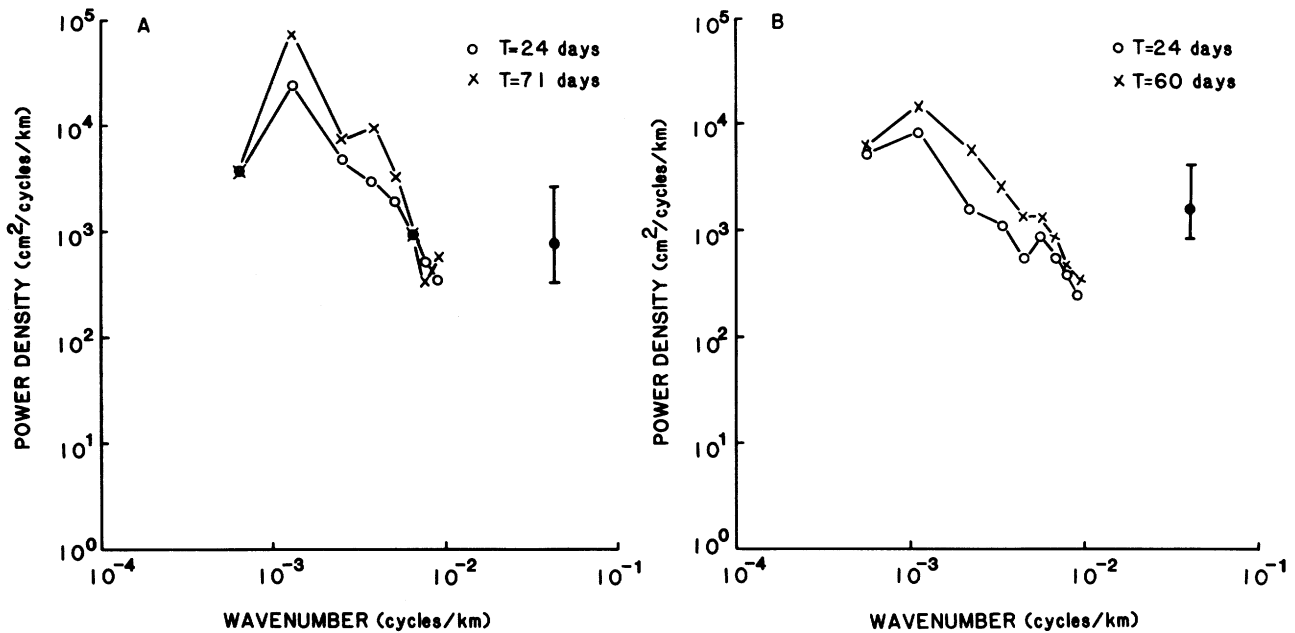

Figure 21. Wave number spectrum (Fu, 1983) from satellite altimetry shown from records of two different durations, and from both high (left) and low energy regions. The longer records yield higher energies, as they should. Future missions of long duration will yield global frequency/wavenumber spectra.

understanding about the ocean circulation, or have at least not contributed commensurate with the costs and nuisances associated with using the data.

Altimetry, and the other variable I will come to presently, stress, does differ fundamentally from temperature, etc. Quasigeostrophic pressure effects penetrate right through the surface boundary layers and are visible from space as deviations of the sea surface from a gravitational equipotential. In

turn, they are boundary conditions that can be imposed directly upon the equations of motion governing the interior flows which are not themselves directly observed. Munk and Wunsch (1982) and Wunsch (1983) discuss the use of altimetric measurements for making direct inferences about interior dynamics and movements.

The other especially exciting variable demonstrated by Seasat was the measurement of the wind stress on the ocean.

## SEASAT ALTIMETER WIND SPEED (M/S)

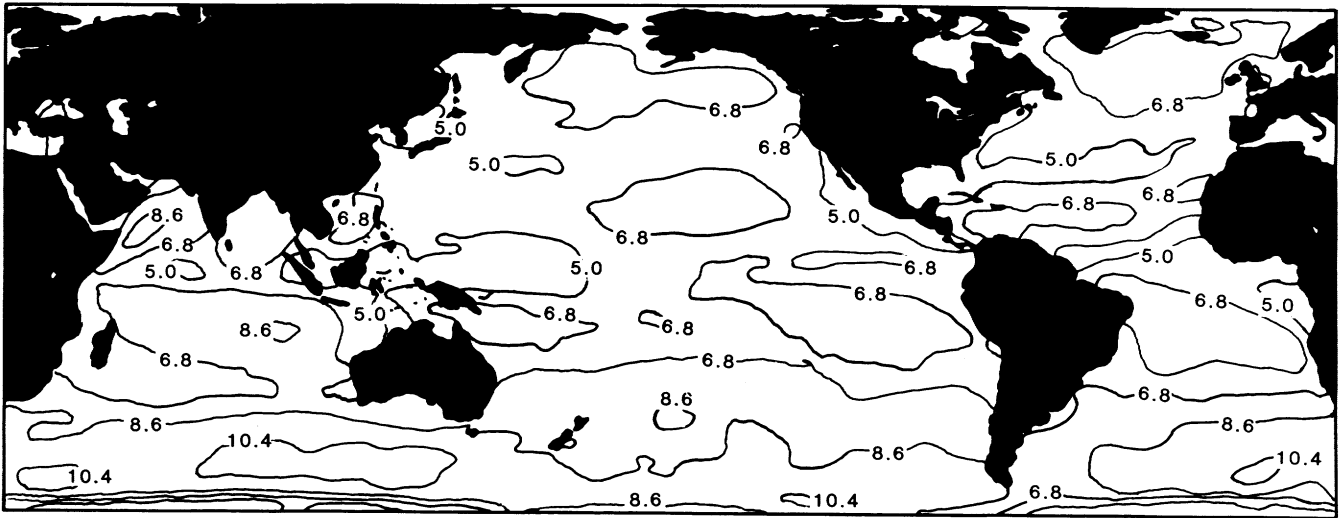

Figure 22a. Global wind speed from Seasat (Chelton et al., 1981). (There is a negative bias in these results (D. Chelton, private communication, 1983) which is correctable.)

Chelton et al. (1981) have published the first charts of global wind speed (Figure 22a) and others (e.g. Brown, 1983) have demonstrated that the Seasat scatterometer also measured vector direction (Figure 22b). Such instruments would yield global wind stress, hence global wind stress curls, hence Ekman divergences. Stress and curl are major drivers of the ocean circulation; at present our best estimates of them are derived from often-casual shipboard measurements, averaged willy-nilly over great time spans and distances. It is often difficult to know what confidence to put in existing observations and it is almost impossible to understand the variations from month to month and year to year which drive changes in the circulation. The Seasat scatterometer (and improved designs exist) showed that we now have the capability for high quality, global, timely, wind measurements.

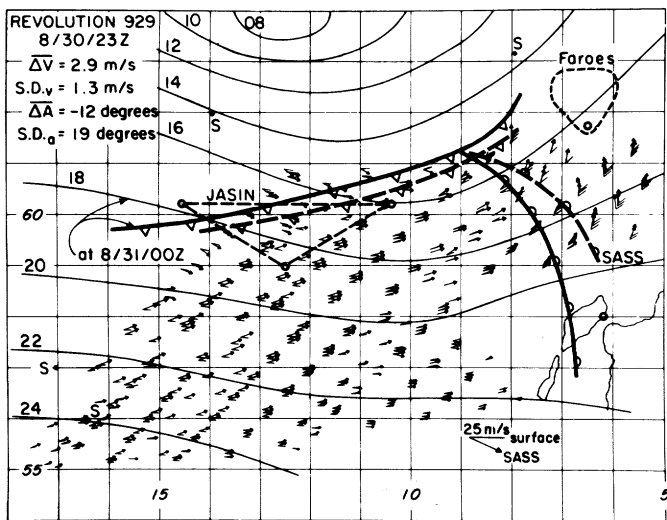

Figure 22b. Local vector wind field from Seasat (Brown, 1983); such charts will be made globally from future missions.

### Making Inferences from Data

Oceanographers are not very familiar with global data sets. The amount of data is very large by conventional standards, and is often derived from highly disparate sources. One needs systematic ways of handling such massive heterogeneous observations in the context of dynamical models of the ocean. Inverse methods (which some would argue were invented in La Jolla, but which others would trace back to Gauss — who seems not to have visited) are a systematic approach to the problem. We all know there are many kinds of inverse procedures although they are widely, and wildly misunderstood in many quarters. It was once explained to me that an inverse procedure is when you know the answer and have to find the question. Some of the examples cited are displayed in Figure 23; the corresponding answers (i.e. the questions) are in Figure 24.

## ANSWERS

1. STRONTIUM - 90  
CARBON - 14
2. WASHINGTON IRVING
3. 9-W

Figure 23. "Answers", which by one description of "inverse theory", must be used to figure out what was the "question".

## QUESTIONS

1. WHAT WAS THE SCORE OF THE CARBON - STRONTIUM GAME?
2. WHAT'S THE CAPITAL OF THE UNITED STATES, SAM?
3. DOES YOUR NAME BEGIN WITH A "VEE" HERR WAGNER?

Figure 24. The "questions" to which Figure 23 are the answers. Uniqueness is not guaranteed.

The reader may now try to interpret the title of this paper. Another form of sophisticated inversion procedure, although not normally going by that name, is what meteorologists call "initialization and assimilation" (e.g. Bengtsson, *et al.*, 1981). Figure 25 displays one of Holland's (1978) "eddy-resolving" models. In a few years, one can anticipate that such models will have grown in scope to portray entire ocean basins with realistic topography and non-adiabatic effects (which they now lack). With the prospect in view of global, time varying-data sets, oceanographers can now sensibly attack the problem of how to analyze those data sets by forcing their models to agree, within error limits, with those observations so as to make inferences about the global ocean circulation.

The systems I have described above are only a portion of those now available for observing the ocean on the requisite large time and space scales. To merely mention a few others, there are: global tracking of neutrally buoyant floats and drifters, rapid sampling of chemical tracers, global gravity

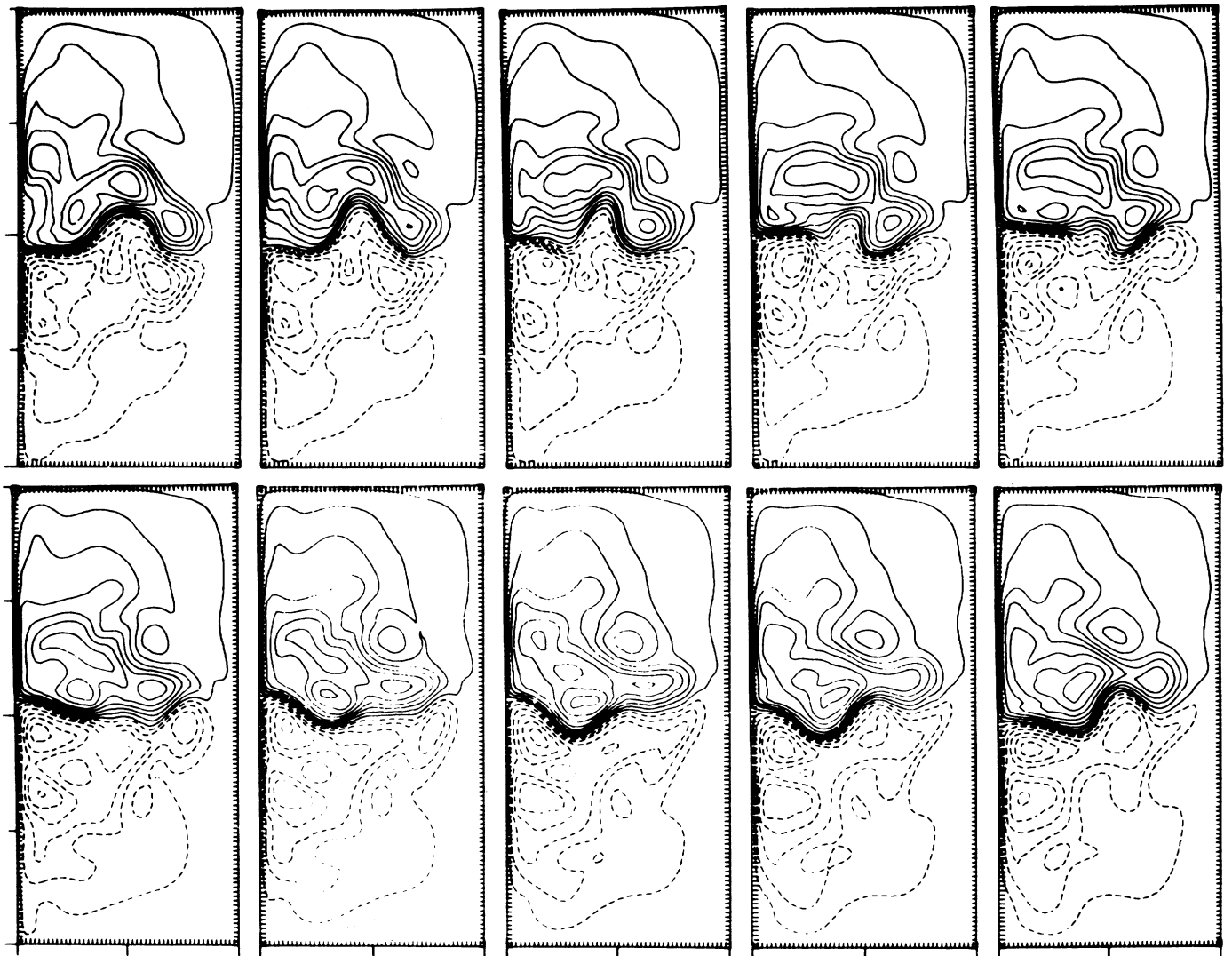

Figure 25. Results of Holland's (1978) eddy resolving general circulation model. In the future one can anticipate that such models will cover the global ocean with realistic thermodynamics.



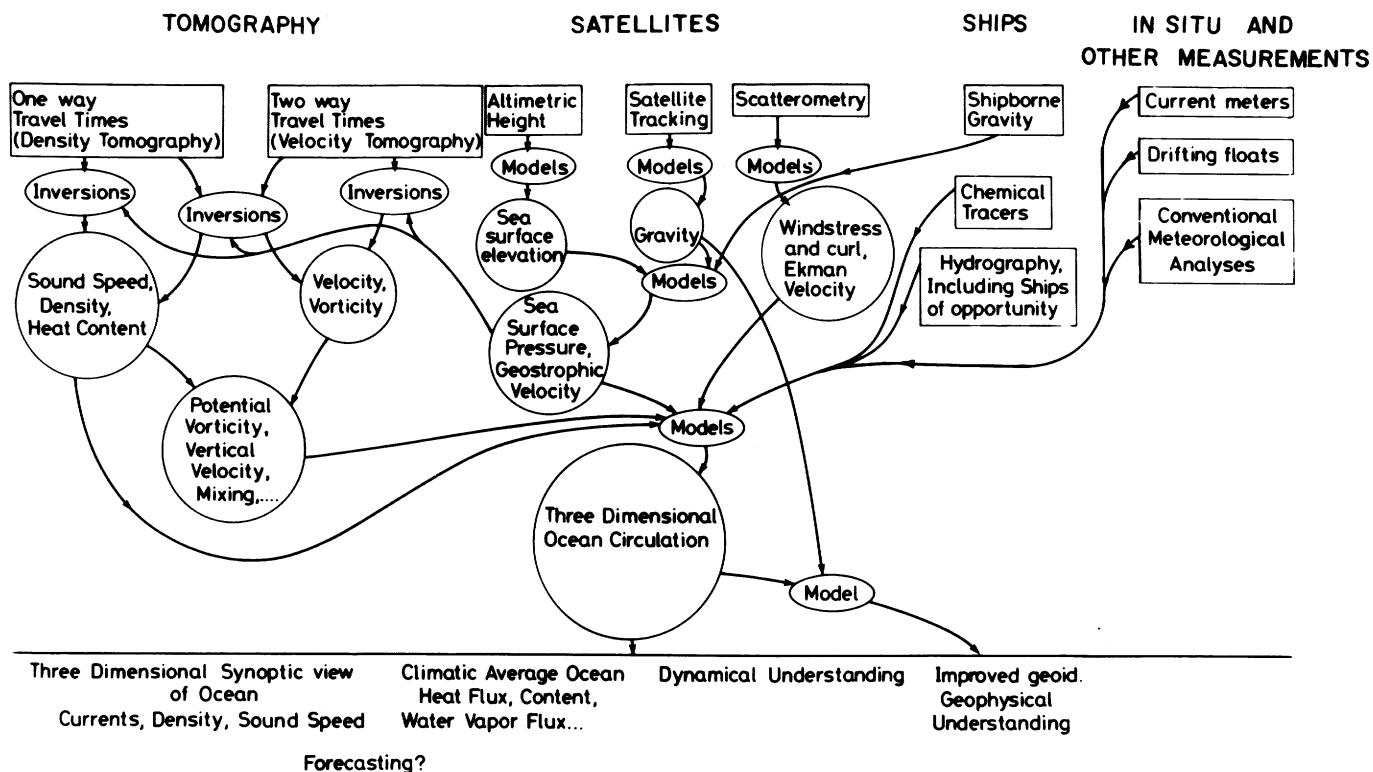

Figure 26. All measurements and models of the ocean can be interconnected to provide global estimates of the state of the three-dimensional ocean. Some side benefits accrue — e.g. improved estimates of the earth's gravity field.

measurements from special satellites, ... In a grand, perhaps mad diagram (Walter wouldn't let me publish it in our joint paper), I have tried to show how they might all fit together and be mutually supportive of each other in a super-inversion to determine the three dimensional state of the evolving ocean (Figure 26).

**Some Parting Remarks**

Amongst some oceanographers, the idea that we could, or should, try to measure the global ocean is greeted with some derision. Those of us who advocate it are sometimes viewed as a cross between a snake-oil salesman and a clown. But harking back to the quotation at the beginning of this talk, I agree that one must occasionally stick one's neck out. On the other hand (Figure 27), I am also well aware of what sometimes happens to those who do.

**Acknowledgement.** This paper is largely the substance of a talk given on the occasion of the celebration of Walter Munk's 65th birthday, 19 October 1982, in La Jolla, California. I would like to thank Walter for making the occasion necessary and thus inadvertently providing an appropriate platform for the propagation of the faith. The cartoons were drawn by Marjory Wunsch. My work on the general problems discussed here has been supported by the National Science Foundation and the National Aeronautics and Space Administration.

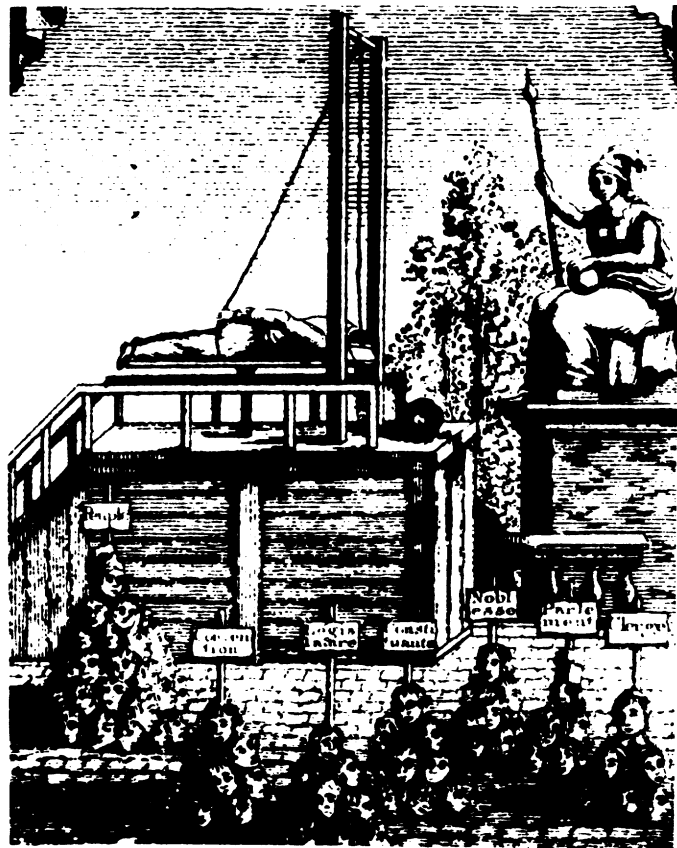

Figure 27. Results of "sticking one's neck out" (see opening quotation) under the wrong circumstances (Matrat, 1971).

## References

- Bengtsson, L., M. Ghil, and E. Källén, eds. 1981. *Dynamic Meteorology. Data Assimilation Methods*. Springer-Verlag, New York, 330 pp.
- Bracewell, R.N. and A.C. Riddle. 1967. Inversion of fan-beam scans in radio astronomy, *Ap. J.*, **150**, 427-434.
- Brooks, R.A. and G. DiChiro. 1976. Principles of computer assisted tomography (CAT) in radiographic and radioisotropic imaging, *Phy. Med. Biol.*, **21**, 689-732.
- Brown, R.A. 1983. On a satellite scatterometer as an anemometer, *J. Geophys. Res.*, **88**, 1663-1673.
- Chelton, D.B., K.J. Hussey and M.E. Parke. 1981. Global satellite measurements of water vapor, wind speed and wave height, *Nature*, **294**, 529-532.
- Cheney, R.E., J.G. Marsh, and V. Grano. 1981. Global mesoscale variability from SEASAT collinear altimeter data, *EOS, Trans. AGU* (abstract only), **62**, 298.
- Cornuelle, B. 1983. Inverse methods and results from the 1981 ocean acoustic tomography experiment. Ph.D. Thesis, Massachusetts Institute of Technology/Woods Hole Oceanographic Institution, 359 pp.
- Fu, L. 1983. On the wavenumber spectrum of oceanic mesoscale variability observed by the SEASAT altimeter, *J. Geophys. Res.*, **88**, 4331-4341.
- Flatté, S., ed., R. Dashen, W.H. Munk, K.M. Watson, and F. Zachariassen. 1979. *Sound Transmission Through a Fluctuating Ocean*, Cambridge University Press, 299 pp.
- Garwin, R.L., W.H. Munk, and C. Wunsch. 1978. Preliminary Report on Ocean Acoustic Monitoring, SRI International, Arlington, VA, JSN-77-8, 30 pp.
- Helgason, S. 1980. *The Radon Transform*, Birkhauser, Boston, 192 pp.
- Herman, G.T. 1980. *Image Reconstruction from Projections: The Fundamentals of Computerized Tomography*, Academic Press, San Francisco, 316 pp.
- Herman, G.T., ed. 1979. *Image Reconstruction from Projections: Implementation and Applications*, Springer-Verlag, Berlin, 284 pp.
- Holland, W.R. 1978. The role of mesoscale eddies in the general circulation of the ocean — numerical experiments using a wind-driven quasi-geostrophic model, *J. Phys. Oc.*, **8**, 363-392.
- Longuet-Higgins, M.S. 1982. On triangular tomography, *Dyn. Atm. Oceans* **7**, 33-46.
- Matrat, J. 1971. *Robespierre, Or the Tyranny of the Majority*, trans. by A. Kendall, Scribner, N.Y., 296 pp.
- MODE Group, The. 1978. Mid-Ocean Dynamics Experiment, *Deep-Sea Res.*, **25**, 859-910.
- Morel, P., M. Desbois, and G. Szejwach. 1978. A new insight into the troposphere with the water vapor channel of Meteosat, *Bull. Am. Meteor. Soc.*, **59**, 711-714.
- Munk, W.H. 1950. On the wind-driven ocean circulation, *J. Meteor.*, **7**, 79-93.
- Munk, W. and C. Wunsch. 1982. Observing the ocean in the 1990's, *Phil. Trans. R. Soc. Lond.*, **A 307**, 439-464.
- National Academy of Science, 1966. The Feasibility of a Global Observation and Analysis Experiment, A Report of the Panel on International Meteorological Cooperation to the Committee on Atmospheric Sciences, National Research Council, Washington, D.C., 172 pp.
- Palmén, E. and C.W. Newton. 1969. *Atmospheric Circulation Systems*, Academic, N.Y., 603 pp.
- Radon, J. 1917. Über die bestimmung von funktionen durch ihre integralwerte langs gewisser mannigfaltigkeiten, *Ber. Saechs. Akad. Wiss. Leipzig, Math.-Phys.*, **K1 69**, 262-277.
- Spiesberger, J.L., T.G. Birdsall, K. Metzger, R.A. Knox, C.W. Spofford, and R.C. Spindel. 1983. Measurements of Gulf Stream meandering and evidence of seasonal thermocline development using long range acoustic transmissions, submitted for publication.
- Spiesberger, J.L., R.C. Spindel, and K. Metzger. 1980. Stability and identification of long range ocean acoustic multipaths, *J. Acoust. Soc. Am.*, **67**, 2011-2017.
- Spindel, R.C. and J.L. Spiesberger. 1981. Multipath variability due to the Gulf Stream, *J. Acoust. Soc. Am.*, **69**, 982-988.
- Swindell, W. and H.H. Barrett. 1977. Computerized tomography: taking sectional X-rays, *Physics Today*, December, 32-41.
- Tai, C.-K. and C. Wunsch. 1983. Absolute measurement by satellite altimetry of dynamic topography of the Pacific Ocean, *Nature*, **301**, 408-410.
- TOPEX Science Working Group. 1981. *Satellite Altimetric Measurements of the Ocean*, Jet Propulsion Laboratory, Pasadena, CA, 78 pp.
- World Meteorological Organization. 1979. Basic Synoptic Networks of Observing Stations, WMO No. 217, WMO Secretariat Geneva, sectionally pagged.
- Wunsch, C. 1983. On inferences concerning the large scale ocean circulation from remote and integrating measurements, unpublished manuscript, 14 pp.
- Wyrtki, K. 1975. Fluctuations of the dynamic topography in the Pacific Ocean, *J. Phys. Oc.*, **5**, 450-459.

# VENETIAN AFFAIRS

Paola Malanotte Rizzoli

*Massachusetts Institute of Technology  
Cambridge, Massachusetts 02139*

It began in November 1966. For four days, with a peak on November 4, the city of Venice was submerged by water, the narrow streets or "calles" flooded and unusable, electricity and telephone service stopping abruptly and normal city life brought to a complete stop. During these four days we lived in a dream-like, suspended atmosphere, continuously watching the water level and waiting. But the water level never seemed to decrease and after the first moments of hurry and panic — helping the people living in basement apartments to get out from their flooded homes and find temporary refuge, getting rushed provisions of food — we got used to this still life which might continue, it seemed, indefinitely.

In the history of Venice, floods are reported as a recurrent calamity. In the annals of the *Serenissima Republic* records of great floods submerging the city go as far back as 800 A.D. (UNESCO, 1969). This is not surprising when one considers that streets are normally less than one meter over mean water level and the tidal range is comparable to this figure. Troubles obviously arise even with a surge half a meter high, which is a rather common occurrence.

The *acqua alta* of November 1966 was, however, exceptional. It reached the unusual height of about 2 m over mean sea level and it lasted far longer than the one-day *acque alte* to which Venetians have become accustomed for centuries. All the newspapers of the world reported the event in big front-page articles. Television networks showed dramatic documentaries of the flooding. World public opinion was all of a sudden focused on the calamity: Venice, one of civilization's unique masterpieces, the world's museum, is being destroyed by nature's ravages. Something must be done.

The consequences of these outcries began to produce concrete actions. International committees were formed to raise funds and help "Venice in peril" to save its historical treasures; ancient books and works of art stored in museum cellars and perhaps irreparably damaged; foundations of buildings slowly corroded by the continuous action of the water; the city's economy — the industrial activity of the harbor — put in serious danger by the recurring floods.

The Italian government also began to move. A series of Italian committees, with the help of international experts, began to be formed to study the problems of Venice and discuss and propose practical interventions and solutions. In the

decade of the seventies these committees, starting from the famous — or infamous — Comitatore, succeeded one another, with endless reunions, newspaper interviews, calling for industries "to propose ideas" and public shows. I am afraid to say that the concrete results of these committees' activities were nil, not an uncommon event in Italian political and "dialectical" life.

Maybe the most serious attempt of the Italian government "to do something" was the formation of a Laboratory of the Italian National Research Council to study Venice's problems — sinking, a geological problem, and flooding, an oceanographic problem — and attack them scientifically.

The Laboratorio per lo Studio delle Dinamica delle Grandi Masse was created in Venice at the end of 1969. Its first director, Dr. Roberto Frassetto, an oceanographer, had lived and worked for many years in the United States, where physical oceanography — the study of the physics of the sea — is a science and not a name usually connected with diving, as in Italy. By the middle of 1970 a group of young graduates — geologists and physicists — had been gathered in the Laboratory. As oceanography does not exist in Italian universities, we were all coming from different specializations in physics, as far away from physical oceanography as elementary particle physics or biophysics. We needed training and exposure to the new field. Dr. Frassetto called to Venice the outstanding names of international oceanography. There were scientific questions to be answered, and the focus of international public opinion was on the problem.

I quote from *The New York Times*, October 6, 1970:

By study of the air, the sea, the land and the water beneath the land, scientists here believe, and by feats of mathematics and technology to match the faith, genius and pride that built this city, Venice can be saved from the ravages of time.

The cost, according to the scientists, will be great, but not exorbitant. And to buttress their optimism, the Italian Government recently announced that it would support a "minimum" program aimed at combatting the five main threats to Venice's continued existence: flooding, wave action, corrosion, subsidence and economic decay.

The current threats to what most consider a precious architectural gem have rallied the talents of specialists from many lands. They include a smog expert from Los Angeles, an authority on tides from La Jolla, California. ...

The authority on tides was Walter Munk.

I remember the first time I saw Walter in the Venice Laboratory. He was visiting for three days, and at the time he had been developing with Frank Snodgrass bottom-mounted pressure capsules to measure sea-surface level. He gave a conference-discussion in the lecture hall of the Laboratory, a beautiful room on the Grand Canal. We all gathered around a massive, eighteenth-century mahogany table, listening with religious awe to the words of science which were being poured upon us and afraid to ask questions.

Walter came back in the summer of 1970 for the first of a series of Summer Schools, organized in the Laboratory to train us in different topics in atmosphere-ocean dynamics. During that first Summer School, our lecturers were Jule Charney, Arnt Eliassen, Allan Robinson and Walter himself. I am not sure how much we understood of what was being explained to us. But those Summer Schools were a perfect environment not only in which to be exposed to the new field — the language and terminology themselves of this new science — but also, and equally important, to get to know these outstanding figures, establish contacts and long-term scientific projects. Those of us, like myself, who were eager to learn and work, greatly profited from this exposure, with consequences sometimes reaching far into the future.

From these first visits, a research project developed between Walter and the Laboratory to study and predict the storm surge of the Adriatic, the Venice *acque alte*. I will now give a brief synthesis of the phenomenon.

The Venice floods are produced by a storm surge of the Adriatic Sea. Even though Venice is located in a lagoon, and not directly exposed to the sea, from the point of view of tides and surges no difference is observed, except for a delay of about an hour from the open sea to the town. Figure 1 (from Tomasin and Frassetto, 1980) shows an example of *acque alte* recorded in Venice, starting April 20, 1967. The anomalous rise at the end of the second day is evident. The increased frequency of floods during this century, proved by the analysis of historical records, is due to various causes. First, the city has sunk about 20 cm since the last century (the "subsidence" phenomenon). Also, the communication between the sea and the lagoon is much wider now due to extensive dredging in the lagoon inlets. A century ago, the peak levels of the outside sea were "cut" by the narrow openings, except for surges of anomalous intensity and long duration, like that of November 1966.

An important feature of the Adriatic Sea is the independence of tide and surge. They seem not to have an interaction, and simply sum up. As the northern half of the Adriatic is constituted entirely by the continental shelf, with very shallow depths ranging from 100 m at shelf break to 20 m in front of the Venice lagoon (Figure 2), this is, at first sight, rather unexpected. In such shallow areas, one would expect important nonlinearities and related interactions between tide and surge. However, the ratio of the depth to the tidal range

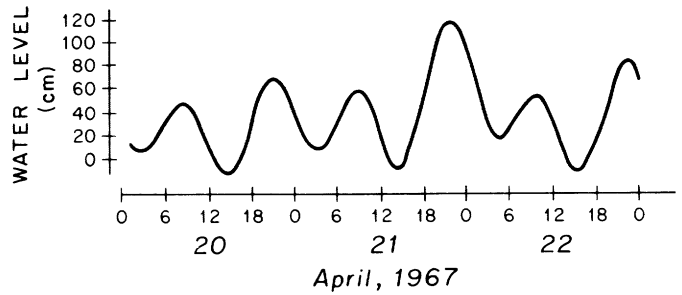

Figure 1. Recorded water level in Venice, starting April 20, 1967. Time is Greenwich Mean Time + 1 hour.

is very large, and this accounts for the observed linearity. Due to this linear superposition, various combinations can occur. Coincidence of surge and flood tide may raise the sea to dangerous levels; at other times, they can cancel each other. The important point is that one can study tide and surge separately, and, given the tidal record, one can obtain a "meteorological tide" by simply subtracting the ordinary astronomical tide.

A second important point is that the dominant tidal periods, 12 and 24 hours, are close to the resonant periods of the Adriatic. The study of its eigenmodes is then fundamental as the Adriatic reacts like a pendulum hit by sharp atmospheric fronts crossing it and starts oscillating. The basic mode of oscillation of the Adriatic Sea (the seiche) has a period of roughly 22 hours. The elongated shape of the Adriatic makes it like an organ pipe (Robinson *et al.*, 1973). Also the dissipation in the Adriatic is very small, and a very slow damping of the free oscillations is observed if there is no further perturbation. Figure 3 (from Tomasin and Frassetto) shows how the seiche can persist for many days.

Thus, a surge usually behaves in a peculiar way as, due to seiches, it can be followed by many replicas of substantial

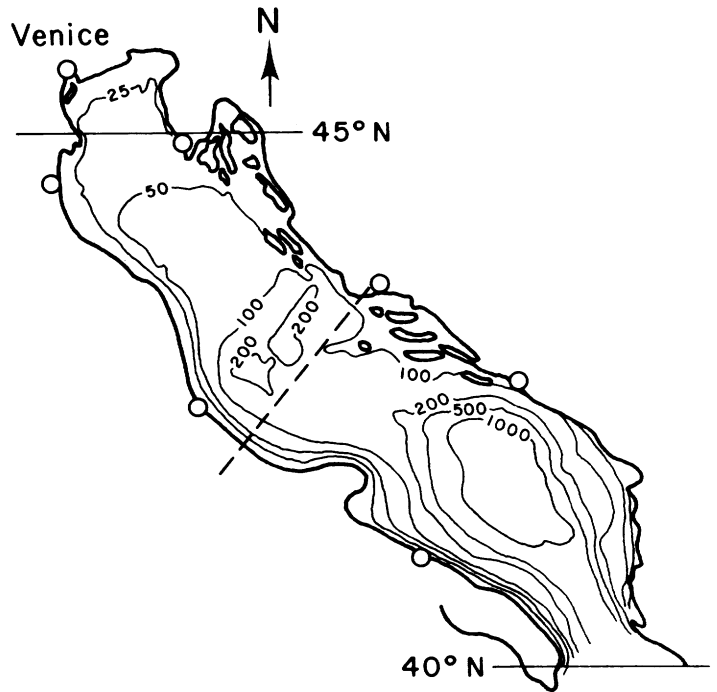

Figure 2. The Adriatic Sea. Depths in meters.

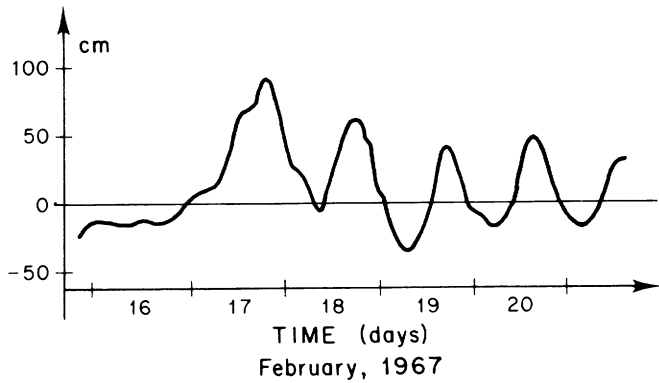

Figure 3. An example of seiche. The ordinary tide was subtracted from the record.

height, spaced less than one day apart. It may even occur that the first arrival of the surge does not coincide with the flood tide, while the subsequent seiche does. The storm has passed and then the flood comes, as was the case for February 1972.

The actual problem, the storm surge, is caused by special meteorological conditions, namely, pulses of southeast wind along the Adriatic. An analysis of the meteorological dynamics giving origin to the *acque alte* shows that frequently these storms originate in the Ligurian Sea, on the opposite side of Italy. The Ligurian Sea is also a site for cyclogenesis, with the depressions migrating eastward and producing the southeast wind blowing along the Adriatic axis, namely, the storm surge. The surge of Figure 1, for instance, is related to the cyclogenesis event shown in Figure 4 (from Buzzi *et al.*, 1978). This meteorological analysis is obviously basic information in the effort to forecast the floods.

The research project between Walter and the Laboratory focused on constructing such a forecasting scheme for the

high water. A variety of predictive models was developed, using either statistical or deterministic approaches — or both. Walter's effort was focused upon a statistical — or "black box" — approach, and some researchers of the Laboratory were concentrated on the project. To work and devote his full attention to it, Walter took a sabbatical period in the fall quarter of 1971 and the beginning months of 1972. With Judy and his daughters, he came to Italy, visiting the University of Trieste and the associated Department of Geophysics with Professor Antonio Marussi, and commuting to Venice. In October 1971, Walter helped the Italian Accademia dei Lincei in the organization of a meeting on the Physics of the Sea at the Trieste International Center of Theoretical Physics. I quote, translating, from Italian newspapers. *Corriere della Sera*, November 1971:

... The only information we have on tides derives from theoretical models or from a very limited number of measurements carried out with bottom-mounted pressure capsules. Professor Munk of Scripps Institution of Oceanography, now visiting the University of Trieste, has spoken on this fascinating topic, illustrating the capsules' complicated technology and the results of a series of measurements carried out in the Pacific Ocean...

Also (*Il Piccolo*, October 1971):

The work of the Meeting of the Accademia of Lincei is going on under the chairmanship of Professor Peter Rhines, with a presentation by Professor Wunsch, MIT, USA, on "Current measurements on the continental shelf".

Peter Rhines and Carl Wunsch were invited to the meeting by Walter. Everybody came to Italy and Venice during those "heroic" years.

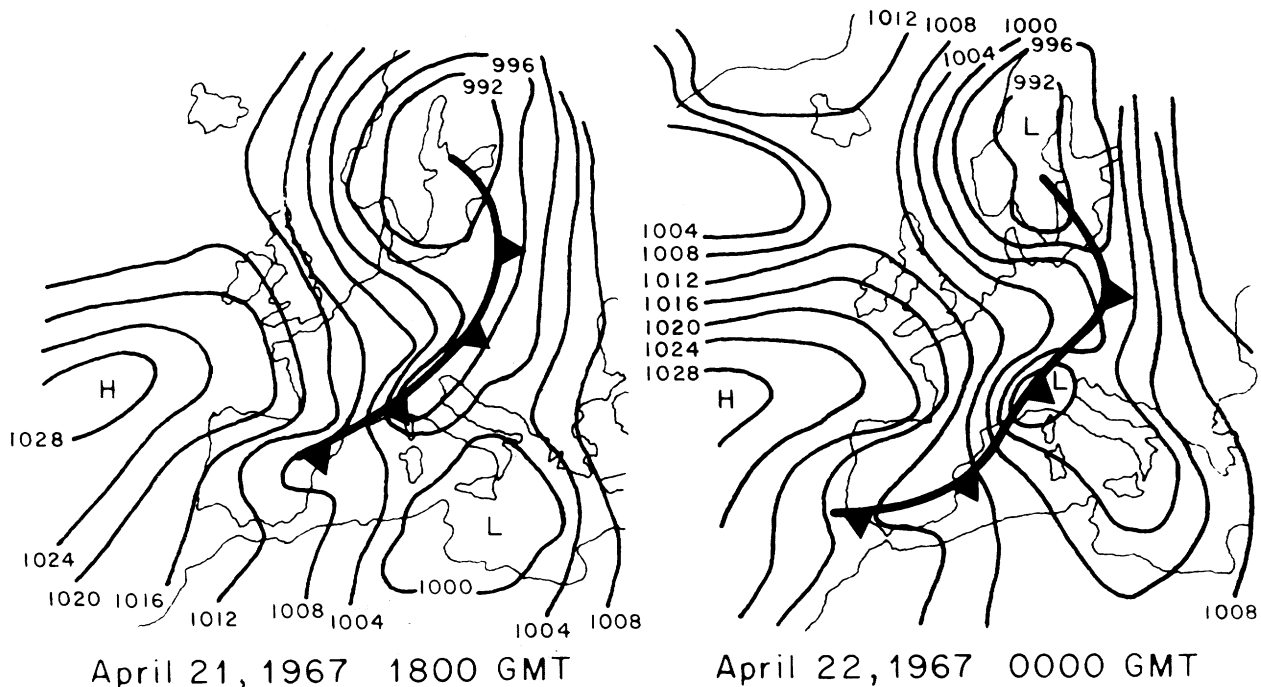

Figure 4. Cyclogenesis event on the Ligurian Sea responsible for the surge of Figure 1.

Commuting to Venice, Walter began to be involved in a series of wide-ranging projects different from the prediction of the storm surge. First of all, he became interested in the destinies of oceanographic research in Italy. Due to the Venice problem, the physics community became aware of the existence of a Physics of the Sea. Walter's efforts in trying to help the establishment and growth of research groups in oceanography, starting with the Venice Laboratory, were deep and extended through many years following 1971-72. His help and enthusiasm were active and concrete in several different ways. He came back to Italy and Venice many times in the pursuit of the ongoing common research projects; he called to Venice a number of scientists, first of all from Scripps, to give us the possibility for new contacts and new collaborations; he visited and talked with the professors in the Italian physics community with a broad and generous scientific perspective, pushing for the opening of oceanographic activity in Italian universities; last, but not least, he offered to all of us ample opportunities to go to Scripps and work there, with continuous scientific enthusiasm and practical aid for our visits. Those of us who took advantage of his help — myself being the first — can only be grateful for it.

Furthermore, due to his interests in arts and Judy's cooperative stimulus, Walter became involved in starting and sponsoring projects for the preservation and restoration of Venetian works of art. From the idea of the "hologram" as a way of reproducing and preserving slowly deteriorating artistic works for future generations, Walter brought to Venice and Florence the "laser" technique, which revealed itself effective in cleaning sculptures encrusted by centuries of air pollution. He called to Venice Dr. John Asmus, an expert in lasers and laser applications to arts. I quote from *Il Gazzettino*, March 1972:

The laser installation in the Venice Laboratory of San Gregorio for Art Restoration has been made possible thanks to the economic help of ENI (the Italian National Organization of Oil Companies), the technical help of the National Research Council and the coordination of the Central Institute of Arts in Rome and of Professor Munk of the California Scripps Institution... . The experiments carried out have shown how the laser can dissolve in a matter of seconds the black crust accumulated on sculptures during the centuries. Carbon, iron oxide, the various silicates have dissolved under the laser beam giving back the original appearance to the sculpture fragment... .

Walter's and Judy's activity in this artistic project were a further and essential motivation for their coming back to Venice. Their efforts in the arts and, in general, in all of Venice's problems resulted in a paper "Venice Hologram", in which their feelings for Venice and what Venice represents are beautifully expressed. I think the best way for me to conclude this short memoir of Walter's involvements and commitments to Venice is through Walter's and Judy's words:

At some point in her history, Venice had been the center of glassblowing, shipbuilding, printing, and banking. She now needs some significant

enterprises, complementing the tourist industry and taking advantage of her natural resources: an unparalleled concentration of art, the most complete and best preserved exhibition of a medieval, Renaissance and Baroque city, her style as a walking city, her location between east and west. Venice could become the center of a museum industry, devoted to the restoration and conservation of works of art everywhere, the distribution of two- and three-dimensional recordings among the museums and schools of the world, the study of associated pollution problems. The varied activities could be decentralized among the scuolas.

But first the devastating floods need to be kept out of the city. It is our conclusion that the technical problems are well on their way to being solved on paper. The impact of the program would be on a par with the diversion of the Brenta and the construction of the Murazzi. Venice could be "saved" for yet another Ruskinian epoch. But there is a real question whether such a program can be carried out with the present diffuse system of authorities. Certainly the Comune is not equivalent to the Serenissima of Venezia Dominante. Many experienced Italians are on the brink of discouragement; they shrug their shoulders: "It is a matter of politics."

It may well be that the situation is ripe for a political innovation as daring as the technical innovation. Could the government of Italy dedicate the 1×2 square miles of land fragments to a suitable authority as an International Historical Preserve, and so make explicit what has, in fact, been the developing situation? UNESCO now has an autonomous program; Venice could become the appropriate center for all UNESCO activities concerning the conservation of art and related problems of pollution.

"The stage of practical operations — the start of work on sites, the building of engineering projects — for which Venetians and their friends all over the world are waiting, has not yet been reached." So prodded M. René Maheu, Director-General of UNESCO, in the spring of 1971. And Lord Byron, 150 years earlier:

Oh Venice! Venice! When thy marble walls  
Are level with the water, there shall be  
A cry of nations o'er thy sunken halls,  
A loud lament along the sweeping sea!  
If I, a northern wanderer, weep for thee,  
What should thy sons do? — anything but weep:  
And yet they only murmur in their sleep,  
In contrast with their fathers... .

Five centuries ago, with these words did the Doge present the newly invested water magistrate:

"Weigh him, pay him,  
and, if he makes a mistake, hang him."

References

- Buzzi, A. and S. Tibaldi. 1978. Cyclogenesis in the lee of the Alps: a case study. *Quart. J. R. Met. Soc.*, **104**, 271.
- Munk, J. and W. Munk. 1972. Venice Hologram. *Proc. Am. Phil. Soc.*, **116**, 415.
- Robinson, A.R., A. Tomasin and A. Artegiani. 1973. Flooding of Venice: phenomenology and prediction of the Adriatic storm surge. *Quart. J. R. Met. Soc.*, **99**, 688.
- Tomasin, A. and R. Frassetto. 1980. Cyclogenesis and forecast of dramatic water elevations in Venice. In *Marine Forecasting*, J.C.J. Nihoul, Ed., Elsevier Publishing Company, pp. 427.
- UNESCO. 1969. *Rapporto su Venezia*. Mondadori, Milano, 348 pp.

# FROM CLOCK-FACES TO ANTI-AMPHIDROMES

David E. Cartwright

*Institute of Oceanographic Sciences  
Bidston Observatory, UK*

I had the privilege of working with Walter on ocean tides at various times in the 1960's and early 1970's. He moved on to other things as is his wont, but I found myself hooked on the subject. In looking through the publication lists of the many scientists who contributed to tidal theory in the past, one is struck by the number of those who, once they started writing on the subject, seem thereafter to have written about nothing else, or to be lured back to it many times during their careers. Others nowadays understandably see tidal science as a fascinating but cumbersome piece of Victorian machinery, still capable of being put interestingly in motion by someone who understands it, but out of place in the new ideas of the modern world.

Working with tides does however encourage a respect for their history. One may use new computing and measuring technologies but ultimately one realizes that one is applying them to the same problems which have puzzled distinguished minds for the last three centuries. We have gotten quite a long way further along the road to solving these problems but they are still not completely solved; it is interesting to reflect on people like Whewell thinking roughly the same thing 140 years ago. I thought that it would be worthwhile for this occasion to put the contribution to ocean tides of Walter and his associates into a historical perspective by outlining the history of the development of ideas about the global tidal map.

For a colorful opening picture to illustrate the state of tidal knowledge at roughly the time of the voyage of the *Mayflower*, I show(ed)\* a clock-face from the wall of an ancient church (St. Margaret's) in the estuarine port of Kings Lynn, not far from Cambridge, England. It shows the phase of the Moon and a dragon-shaped hand which rotates through 24 divisions, alternately marked by the letters LYNN HIGH TIDE, in a synodic month. These divisions may be interpreted as the rough time of one of the "High Waters" of the day on a 24-hour system, (the other HW being about 12½ hours before or after). A local merchant would thereby know when to expect his ship to sail over the bar and into port, and even how strong the flood would be — from the lunar phase. That was probably all he wanted to know about

the tide. Our ideas have been getting more and more complicated ever since.

At about the time that clock was constructed, the Elizabethan philosopher Francis Bacon, also known for being suspected by some to have written Shakespeare's plays, expressed curiosity at the recently ascertained fact that the tides on the Atlantic coasts of Florida and Portugal are nearly simultaneous. He speculated (in Latin) whether this property holds right across the ocean and what that might imply.

The first attempt at a tidal map has been attributed to the physicist Thomas Young, who in 1807 drew a small sketch of the British Isles with hour numbers round the coastline to denote the tidal times, included as 'Figure 521' in a now rare volume of notes for his educational lectures to the Royal Institution, London. An equal claim could be made for the polymath-scientist Edmund Halley a century earlier. Halley's chart of the English Channel, based on his own 1701 survey in command of the *Paramore*, included lines of equal tidal times between England and France, and an area denoted by the words "Here the two Tydes Meet". This last is an area southwest of Dover where the progressive waves up the Channel and down the western North Sea produce something like a standing-wave regime — Halley was concerned with tidal streams as well as elevations.

William Lubbock, better known for his work on tide-prediction, included in a paper to the Royal Society of 1831 a world map with High Water times round all coasts and some tentative straight isopleths across the Atlantic (following Bacon's remarks). The time for Bermuda made the straight-line hypothesis look doubtful. Lubbock worked closely with the Reverend William Whewell, Master of Trinity College, who was the first to dare to draw a complete set of curvilinear isopleths joining Lubbock's coastal values, covering most of the oceans shown except the Pacific. Whewell's map accorded with a new hypothesis, that the tides are basically generated in the Southern Ocean, where alone the tidal forces have an uninterrupted run round the meridians; the tides in other oceans were supposed to have radiated from the Southern Ocean. (This concept has long since been abandoned, but it was recently re-explored analytically in a paper by Adrian Gill.)

Whewell did not at first conceive of amphidromic (nodal) points, but the circular progression of phases round the Southern part of the North Sea later inspired him to propose

---

\*I shall not reproduce here the many illustrations used in my talk; most of them may be found in the standard literature.



the existence of such a point about half way between East Anglia and Holland. Someone in the Admiralty thought it would be nice to verify this and in August 1840 a small boat party under the command of a certain Captain Hewitt R.N. spent a calm day at an appropriate spot making hourly soundings of the bottom with a lead-line in 18 fathoms (33 m) of water. The soundings varied by only 1 foot (0.3 m) which was about the accuracy of measurement, thus confirming Whewell's conjecture. The next group to locate an amphidrome by direct measurement was Walter Munk, Frank Snodgrass and James Irish between Hawaii and California, 130 years later.

Whewell's North Sea amphidrome had an odd sequel. G.B. Airy, the Astronomer Royal, re-drew Whewell's map with the amphidrome replaced by a confusing mass of intersecting lines. This was re-interpreted yet again by various Admiralty authorities to produce a quite erroneous tidal chart which persisted as the official guide of the British Navy well into the 1920's. It was finally replaced by a proper map computed by Proudman and Doodson of the Liverpool Tidal Institute, which correctly depicts all three amphidromes of the North Sea system, including co-amplitude contours which all others had carefully avoided.

The American hydrographer Rollin Harris was the first to perceive that amphidromes were required in the deep ocean too. He placed one in each of the North Atlantic and Western Indian Ocean basins and three in the Pacific, as well as several near-shore systems, (all for  $M_2$ ). Harris was also the first to make use of bathymetric data which were then (around 1900) just becoming available from deep ocean soundings. He used these data to calculate the approximate dimensions of resonating basins into which he divided all oceans as a basis for his tidal maps. However, like most other early 20th century tidalists he vastly under-estimated the amount of computation required for even an approximate solution to Laplace's equations over an irregular sea, and his methods incurred the scorn of G.H. Darwin. Harris's later years were spent trying to construct a convincing tidal map of the Arctic Ocean. He had sufficient confidence in his method to postulate the existence of an undiscovered land mass near the North Pole, but it was probably the tidal data available to him which were principally at fault.

I must skim over the work of the later empiricists, Sterneck and Dietrich, and also the more profound work of the "Lamb's Hydrodynamics" school whose leading exponent was Joseph Proudman. Proudman's work tends to be disregarded these days, but a study of his papers on tidal mathematics shows that he was well aware of modern problems. His tentative solution for the  $M_2$  tide in the central latitudes of the Atlantic looks nearer the truth now than he probably realised in 1944; his series of papers which started in 1916 formed the essential basis of George Platzman's recent forward-looking calculations of the normal modes of the world oceans.

A new era of research, aimed at defining the global tidal maps for all the major harmonic terms by means of post-war technology, got underway about 1960. Much of the stimulus which kept this movement alive came from Walter's enthusiasm, his research groups working on all aspects of the

subject, his deep-sea tide measurement programme, the Geotape data-bank, the SCOR Working Group no. 27.

I was involved in WG 27 to the extent of having to wind up (in 1975) a group started by Walter (in 1967). The group had to be wound up because it had served its purpose in doing all that could be done to stimulate international awareness of the importance of finishing off the job of defining the ocean tides for the benefit of geophysical sciences. It had hoped to do more than this, by setting up and coordinating a global measurement program geared to computer models which would finally be tuned to give an accurate solution to the tidal equations with all known geophysical inputs at all relevant frequencies. Things did not work quite so well as that. Of the seven or eight countries whose representatives eagerly attended the early meetings, only four were prepared to fund the instrumentation necessary for deep sea tide recording, and finally only the UK and USA have ventured more than a few hundred miles from their own coastline for this purpose. As a result, more than 80 percent of the pelagic tidal stations occupied to date are in the North Atlantic Ocean, where the tides are least controversial.

Meanwhile, the numerical modellers have made steady progress, from the first tentative global tidal solution by Pekeris and his associates (shown in draft to an IAPO audience in 1960 but published in 1969) to the nearly realistic solutions for some eight harmonics by Parke and Hendershott and by Schwiderski, published around 1980. These have made very little use of the pelagic measurements; where measurements have been used at all, the large data bank of coastal and island tidal stations, held for decades by the International Hydrographic Bureau, have sufficed. The growing importance of *anti*-amphidromes (areas of maximum amplitude) has made an ironic contrast with the traditional pre-occupation with nodal points. It is also ironic that when modellers have called for measurements at the few anti-amphidromic regions in the world oceans, no one has been able to afford to send a ship there.

The most recent stimulus to improve tidal maps has been the need to apply tidal "corrections" to satellite altimetry for the precise monitoring of geostrophic currents. Corrections for the solar tides are particularly important because they are usually aliased by the orbital configuration into very low frequencies. At first, an accuracy of 0.1-0.2 m was considered good enough, and the most recent tidal solutions appear to satisfy this condition, but the next generation of altimetry aims at 0.05 m precision. Nobody can be sure whether this can be achieved, because the tidal solutions have been more or less rigidly constrained to agree with most of the known data (less rigidly in the case of Parke and Hendershott). It is hard to find new data in the South Indian or South Pacific Oceans with which to test the models. Most recently, I have acquired some Norwegian pressure data from the Weddell Sea which point to a 0.3 m error in the  $M_2$  amplitude of Schwiderski's map in that area. The map can no doubt be re-computed to set that particular error to zero, but one wonders if there are others, at present undetected. A few of us hope that such questions will be finally answered by the altimetry itself.

Finally, I cannot leave the subject of tidal maps without at least a paragraph on a problem which has always been dear to Walter's heart and which is the central one in all tidal theory – the dissipation rate. Twenty years ago, one of the main reasons for striving for a global  $M_2$  map was to provide a lower bound to the total loss of rotational energy in the Earth-Moon system. The accepted dissipation rate deduced from lunar acceleration was then 2.7 TW, of which 0.5 TW (Heiskanen) or 0.2 TW (Miller) was supposed to come from friction in the Bering Sea. Recent revisions of the astronomical evidence have put the figure up to about 3.5 TW for  $M_2$  (4.2 TW total) while Sündermann's model of the Bering Sea suggests that it contributes less than 0.1 TW. These figures alone would seem to indicate that our understanding of tidal

dissipation has gotten worse instead of better. However, integration over the numerical models does now give figures near 3.5 TW for  $M_2$ , which moreover is confirmed by perturbations to satellite orbits (Kurt Lambeck's survey). The paradox exists because the models achieve near-agreement by means of generalized global frictional coefficients, whereas our lack of knowledge concerns the detailed physics of the localised sinks of energy in shallow seas. As my group's study of the northeast Atlantic showed, direct measurements of localised dissipation can be quite different from that assumed by numerical models. Trying to quantify the localised distribution of energy sinks in the world ocean seems to me to be the last remaining obstacle to progress in our two centuries of effort to produce a set of correct tidal maps.

# SCIENTISTS, SECRECY AND NATIONAL SECURITY

Richard L. Garwin

*IBM Thomas J. Watson Research Center  
Yorktown Heights, New York 10598*

(also Adjunct Professor of Physics, Columbia University)

The involvement of scientists with secrecy must go back to ancient times. Not so long ago it was common to publish results (which presumably one hoped were both important and correct) in encrypted form. This would ensure one's priority without giving the scientific competition the benefit of one's contribution — an ancient analogue to the appliance store that offers to match any price. You just buy the appliance there and if you find a lower price some place else they'll reduce theirs. It doesn't do much for the economy and it didn't do much good for science either. But if one or one's group is an infinitesimal fraction of the scientific enterprise, it doesn't do much harm to science unless one considers the collective phenomenon associated with the adoption of such a policy.

Imagine, though, the effect on the science of oceanography if Walter Munk had published in anagrams or in purposely obscure journals instead of in accidentally obscure prose.

Yet there is a place for restraint in communication. The researcher with substandard facilities and a heavy teaching load may be reluctant to share his brilliant ideas for detecting magnetic monopoles or explaining the extinction of dinosaurs for fear that some more fortunately placed scientist will obtain the results first; and the hapless graduate student with a promising idea for her thesis is another example.

Little do these scientists know the depths of protection afforded them by the general tendency to reject all but conventional wisdom.

Strangely, one can find in well-placed, renowned scientists a resistance to talking freely about their on-going work (not associated with Walter or Bill Nierenberg). One can even imagine doing first-rate science without writing it down or publishing it, but such a practice is about as enduring as a species which has not invented a means of reproduction.

If science is the understanding of nature (meeting the test of prediction), technology is the knowledge of materials and processes toward useful ends. It may be very much in the interest of a community or a nation or the human race to gain some scientific understanding or technological power, and still not be rewarding to any individual to do so. For a scientist to spend his life to understand and cure the common cold (assuming he has the average of five colds per year) is hardly a rational investment, unless he feels some fraction of

the benefit to the hundred million or billion other beneficiaries. And even if he should feel it, he had better be of independent means in order to do the research.

Centrally planned societies have no trouble aggregating benefits and paying researchers, but they tell them what to do. In the Soviet Union the only scientists who can publish are those who are paid by the State and assigned work. Philanthropists in our society see this dilemma and have often given large amounts of money (amassed in more-or-less respectable ways) to combat disease or poverty. Democratic administrations tend to regard this as subversive of the will of the people and as tax expenditures which should be subject to the annual decision of Congress, while Republican administrations tend to eliminate federal funding either preemptively or as the result of the availability of private funds. No one loves philanthropists; it's a good thing they have money with which to console themselves.

In recent years Republican administrations have also been suspicious of foundations which tend to benefit people who, if they were of any merit, would have been rich.

But faced with the prospect of paying hundreds of dollars to cut down and burn a diseased elm tree (if one should be so fortunate still to have an elm tree) a homeowner might still pay \$50 for a cure which might take many years of scientific work to understand the Dutch Elm fungus and its vector. If the manufacturing and delivery cost of the cure is small enough to be preferable to allowing the death of trees, it might be produced, but how will the scientific investment and the acquisition of the knowledge of technology be repaid? If the support was public, the public benefit is enough; but if the support is to be private, there must be an expectation of recovery of costs. We have two mechanisms in this country — trade secrets and patents.

A trade secret is exemplified by the Coca-Cola formula, some years ago by the process of developing color film, or sometimes the existence of a fancy tool for diamond machining or of a particular bug in genetic engineering. Patents are quite different. They repay the total revelation of information (meeting the test that anybody skilled in the art can practice the invention) by a 17-year absolute right to keep others from practicing the invention or selling the product of the invention in this country. A trade secret is not protected

against chemical analysis of the product or against inadvertent disclosure, but it *is* protected by the laws of ownership of property against theft, espionage, and the like.

So there is a lot of commercial secrecy — that is, trade secrets — in oil companies, about the performance and the release date and the name of a product, about the interest rate decisions of the Federal Reserve Board and so on. Even in patents some secrecy is mandatory in the United States, because revelation prior to one year before applying for the patent is an absolute bar to the issuing of a patent, and in most foreign countries the problem is greater because any revelation prior to application voids the patent.

So temporary secrecy and rights of exclusion are essential if support of science and technology is not to be entirely from public funds and by public decision. Still the scientific and technological contributions of industrial laboratories — Bell, IBM, Philips — are not negligible even though they have some requirements for pre-patent secrecy and occasionally for the close-holding of know-how as a trade secret.

My thirty years in industry, however, persuades me that it is possible for even such a large organization to understand its debt to open communication and to provide as much as possible of its results to aid the development of science and technology, and incidentally to enhance the reputation of the organization and its ability to attract capable (we hope, occasionally, outstanding) scientists.

But of course my topic is the intersection and not the union of scientists, secrecy and national security. Otherwise it would be enormous in scope. Nations have secrets not only about their intentions (which even they may not know), but also about their capabilities or lack thereof (which again they may not know).

Our ignorance of the capabilities and intentions of potential adversaries can be extraordinarily costly and maybe even dangerous. Well-known examples are our ignorance (at the time) of the famed missile gap of the Kennedy campaign of 1960 and again our ignorance of the Soviet program to put offensive nuclear-armed missiles in Cuba in 1962 — the Cuban Missile Crisis. According to the book by George Kistiakowsky, the Eisenhower administration in 1960 had full confidence that the Soviet Union at that time did *not* have the hundreds of ICBMs claimed by the Democrats in their campaign, but only a few. But they could not tell even trusted government advisors associated with John Kennedy. The decision not to share this information led to the deployment of 1000 Minuteman missiles as a consequence of the campaign rhetoric, even though Robert McNamara as Secretary of Defense told President Kennedy that 500 would be more than enough but that Congress would never let the Administration deploy so few.

Obviously scientists have been involved in creating the systems of high capability which help to penetrate the secrecy with which nations try to hide their capability and intention. And to penetrate even the privacy of individuals. Some examples are given in Solzhenitzen's book, *The First Circle*, in which scientifically trained political prisoners in the Soviet Union worked on techniques for identifying speakers overheard on telephone lines.

Naturally scientists have also been involved in protecting secrets. An instance is the invention of systems of encryption — one type is the Data Encryption Standard (DES), approved by the National Bureau of Standards and available in the United States in computer chips or software for the protection of non-defense information.

Some security is desirable and necessary even in non-military activities. Envelopes and encryption and rules of behavior are supposed to keep unauthorized individuals from transmitting supposedly valid orders for electronic funds transfer or from learning in advance of the decision of a major corporation to bring out a product at a certain price on a certain day, or from learning of the decision regarding discount rates for the next period, or even from learning that your home has been vacated for the evening so the burglars can visit. A society of totally free information exchange would be very different from the one we have now.

On the international scene, the Soviet Union and the United States have formally accepted the acquisition of certain types of information by national technical means, namely information required to verify the undertaking of the SALT I and the SALT II agreement.

I can't speak further about these matters, but they involve directly only a small fraction of the scientific community. My *real* topic before we go on to discussion (which I encourage) is the role of secrecy in scientific work and its effect on national security.

First, national security, like wealth, should be measured on an absolute scale, not relative to another nation or individual. It does the individual little good to take measures to insure that he is wealthier than his neighbor, if such policies result in his being poorer than before. Enhancements of national security by spending more money to deploy more forces may make one more secure than the opponent (but probably don't), but the resulting decline in overall security may cause an absolute loss in one's own. And besides, national security has a lot more to it than military capability and even than protection from invasion or conquest. At present in the United States, information relating to the nuclear energy is born SECRET under the Atomic Energy Act of 1954, no matter whether that information is the result of government or industrial or individual effort. But classified information relating to national defense in general is treated totally different and can be created only in government-sponsored work. Under the law there are some few exceptions such as cryptography or information about troop movements but in general, as regards non-atomic-energy information, penalties are prescribed only when an individual has an intent to injure the United States and communicates with a foreign power. Nevertheless, actions have consequences, and many individuals, recognizing potential damage which could be caused by publication of certain unclassified information, keep it to themselves.

However, the criminal law is one instrument, and civil or contract law is another. Increasing use is being made of contract provisions of employment or of access to information classified TOP SECRET, SECRET or CONFIDENTIAL (according to whether the unauthorized release of information will cause extremely serious damage to the U.S. national

security or foreign relations or lesser amounts of damage). Access to properly classified information is for government purposes only and it's based on the certified reliability of the individual, as determined by having an active clearance, and on a certification of need-to-know. Of course these conditions can be interpreted more-or-less strictly.

Such a system has obvious benefits and hazards for the nation. For one, it retards scientific, technological or operational capabilities of potential adversaries (yes, there is science applied to operations, not just to creating new things). It creates or preserves uncertainty as to our capabilities and status. It reduces public criticism of the merits, management, or conduct of the program (which must be regarded by those involved as a benefit).

But it has hazards. It retards the same scientific, technological, and operational capabilities of allies and allied services — things which are classified by the Air Force and not necessarily available to the Navy and especially vice versa. It creates uncertainty as to our capabilities and status and so it impedes the work of scientists (especially young ones or those new to the field), and by reducing public access and criticism it eliminates one of the strengths of the democratic system in doing those things which are best for the country. Secrecy impedes the work of the program itself and of the cleared scientists involved, because it creates impediments to access — it may take six months or a year for people to get clearance — difficulties of document distribution, inability to work at home. It raises the cost (probably doubles the cost of many programs). It reduces or eliminates the benefits of competition and it substantially impedes the cross benefits from the scientific results and tools developed in the program. In a large technologically advanced economy like ours, secrecy very much impedes the use of scientific and technical results by industry in support of the civil economy and thereby reduces the potential of the technology and the economy to support defense and security programs.

Here I want to make a personal remark rather than an analytical comment. As a matter of personal choice I find it exceedingly distasteful to work in a field in which I do not have free access to the status of science and technology. There are recurrent suggestions from funding agencies and program managers to the effect that a scientific inquiry should not be fettered by knowledge of the status of the field, but my judgement is that scientists protect their ignorance very well without such barriers. I don't want to waste my efforts reinventing the wheel, or worse — constructing tenuous chains of analysis which could have been disproved at an early stage by comparison with experiment or observation. To the extent that there are others who feel the same way, sponsors of research will impede progress in their field by not granting full access when they sponsor work in a field. And putting people to work without full knowledge of the field increases the hazard of unwanted information transfer. How can one protect material one invents if one is not told that it duplicates or improves on highly classified information?

Not everything about secrecy is bad. The benefits and costs of classification depend on the scale of the program and whether it's localized or distributed. There are some big

successes. For instance, the wartime effort at Los Alamos and the Manhattan Project in general has to be counted as a success. My own access to this work began in 1950 when I spent the first of many summers at Los Alamos. I was very much impressed with the internal program of publication which was begun in 1943 at the laboratory. As one new to the field, I spent days in the library, read progress reports of the various groups, scientific papers written by the participants for their colleagues and successors, emphasizing to me that publication is communication not only in space but in time.

But there's always a large overhead in secret work. Security officers, guards, classification guides, safes, clearance passing, counseling, mail registry, receipts, delay, inability to communicate with the person who could be of greatest help. In a day of science dependent on remote computer terminals for access to computation, to data and results, the lack of modern infrastructure for classified distributed work is crippling; and we would need (should have, because secrecy will be with us) dial-up encrypted telephones, satisfactory encrypted remote-access terminals certified for classified work, more efficient express-mail service authorized for classified mail, and the like. Not to have such systems thoroughly impedes the government efforts to improve its situation.

In summary, a large project located at one site can operate efficiently even though the results are secret. But if *that* science is not to lose much of its value in other fields, there must be (and usually is not) a concerted effort to declassify, excerpt and publish broadly what can be published.

Science is underfunded even in enlightened societies because one imagines that *particular* science may contribute in a particular field. But algorithms and tools and instruments and insights are more widely beneficial, and any economic analysis will result in more scientific work than we do. To the extent that these indirect contributions are inhibited or delayed by secrecy, the value of science and scientists is reduced.

The United States is extraordinary among nations in having academic scientists deeply involved part time as consultants in classified programs. Some, like Walter Munk, may work in classified fields allied to their university work and have both judgment and incentive to publish as much as can be permitted. Others may work in fields very different from their normal academic work and serve to contribute, and to transplant tools, but they have no occasion to prepare publishable papers on their classified research. I believe that the scientific, technological and industrial health of the United States is clearly linked with the freedom of the individual scientist to choose and change the place of work, with the lack of restraint on dissemination of scientific results, and with the involvement of outside scientists in classified work. In the Soviet Union none of these conditions exist. And in several advanced countries, academic scientists are hardly involved at all in classified work.

In the United States (at least since 1969 with the great ABM debate) we are much more open in the discussion and choice of weapon systems; this has forced more fervid

misrepresentations on the parts of various agencies to accomplish what was formerly done simply by assertion. It is not necessarily a gain.

The present is a time of great peril. Persons who seem to have been appointed to government positions primarily because they know nothing (except they know they don't like the Soviet Union) recognize that the Soviet Union benefits from U.S. science and technology and wish to eliminate this benefit. But too many of them don't distinguish actual knowledge of U.S. weapons and tactics from technologies of wide application or from scientific results which have within them the prospects of contributing to weapons, to countermeasures, to medicine, to industry, to consumer goods across the spectrum. They argue from the undisputed fact that the Soviet Union pays a lot of attention and money to penetrating military security and obtaining plans and test results and equipment from AWACS radars (plans for countermeasure suits of the F-16 fighter and so on), and that Soviet workers spend a lot of time in libraries looking up publications. They argue from that to the conclusion that publication and dissemination of scientific results in the United States should be restrained. They are wrong.

Last month a committee under Dale Corson convened by the National Academies presented its report on technology transfer to the Soviet Union. A subgroup had access to classified information and presentations about the problem. The committee concluded that the United States government should take more seriously its responsibility to protect properly classified data in order to reduce the availability of countermeasures to U.S. weapons and to reduce the ease with which the Soviet Union can build modern weapons based on U.S. technology. But they strongly assert the lack of evidence for damage to the United States caused by Soviet acquisition of unclassified scientific or technological results. Their report recognizes, but does not *quantify*, the damage to the United States science, technology and industry which would accompany constraints such as excluding Soviets (and here do we mean Soviet nationals, Soviet agents, Soviet sympathizers?) from university courses, colloquia and buildings and from restricting the distribution of unclassified results of U.S. government-sponsored research.

Last month, the Department of Defense forced retraction of 120 papers from the Society of Photo-optical Instrument Engineers conference. These papers had been reviewed and approved for publication by the contract authorities. This action of the Defense Department makes a political statement, but the first fruits of such actions will be a reduction of the flow of technical information *within* the U.S. technical and industrial community, adding to the natural disinclination of engineers to use the technical results of anybody else. U.S. commerce and industry will suffer, especially small technical firms. The cost to the Soviet Union of obtaining this information might be raised slightly, but only a bit because of the economy of scale available to them because they want so much information. The cost may even be lowered if the U.S. does part of the job for them of identifying and categorizing information of particular value, without actually classifying it.

Don't think it can't happen here. A few new laws can destroy the system of openness which has served the U.S. and world science so well. Even though your representatives in Congress know better, they may find it politically compelling to vote restrictions on the free publication of scientific information. One need only look for confirmation to the aftermath of the 1973 Roe v. Wade Supreme Court decision affirming a woman's right to choose abortion, and the recent years of battle to reverse or circumvent that decision.

New restrictions will have effect even if rarely enforced by penalties, because the vast majority of corporations (including universities) will not knowingly act outside the law. The irony is that, in their dislike of the Soviet Union, these advocates of information restraint will transplant here some of the most detested and counterproductive aspects of Soviet society, in the same way that others cannot countenance our different choices of weapons and insist that if the Soviet Union has large ICBMs (or if they have 40,000 tanks) we have to have them also. I suppose we are behind in the prison-camp race.

We celebrate the 65th birthday (but really the scientific exuberance) of Walter Munk and his influence on many fields of science directly and through his colleagues and his students. He is also a fine example of contribution to the national security in his science published openly and in reports properly classified. To attempt to deny the Soviet Union access to his open scientific results would have hurt us more than it hurt them.

The question of waging economic warfare against the Soviet Union in peacetime ought *really* to be put to the American citizenry because that is what some in the administration want to do.

Now on the economic scene, one could quote Rudyard Kipling

"They copied all they could follow  
but they couldn't copy my mind  
and I left them sweating and stealing  
a year and a half behind."

That's good for technology but it might not be good, for instance, in the dissemination of knowledge about nuclear weapons, because there is a declining utility of information about nuclear weapons. When somebody can make a rather poor (not very advanced) nuclear weapon, it is almost as great a threat to world peace and to the U.S. security as if they can make a fine modern one. So in addition to restricting information, eventually one has to make a decision as to *actions* to be taken in the event; we badly need a policy for what to *do* to deter the acquisition of nuclear weapons. Information security does not solve all problems.

#### QUESTIONS:

VOICE: If I can be facetious perhaps, there seems to be a very good solution to one of those problems, and that is that we should all go out and get published more and more in journals.

RLG: I think refereed journals are very important so that we don't waste our time reading things which should not have been published. Yes, there are a lot of ways to deny anybody

else information and that is one of them. Eliminating the information is another. The real problem is to transfer information adequately, to encourage people to use information which is available in order to benefit our society, while denying some critical information to the other side.

VOICE: Do you have a rule-of-thumb for what ought to be classified?

RLG: Certainly if you build systems which are for military use, whose effectiveness depends on the lack of information on the other side, then that information should be classified. It should also be *available* in a proper community, because one needs to know the inadequacies of our systems in order

to improve them; and one needs to know what information the other side may be looking for in order to have proper security measures. As one goes back to *techniques* which are involved in weapons, for instance metal-forming techniques for fighter aircraft, or computers which are going to be used in aircraft, one has to analyze whether keeping that information secret really reduces our wealth more than it impedes the other side — taking into account the ability of the other side (whatever that other side may be at that time, or might be in the future) to make use of the information. Sometimes it isn't lack of information which keeps them from making advances, but inadequacy of their organization.

# THE GREENHOUSE EFFECT AND ACID RAIN

Gordon J. MacDonald

*The MITRE Corporation  
1820 Dolley Madison Boulevard  
McLean, Virginia 22102*

Two issues — the projected climatic changes due to the build-up of carbon dioxide in the atmosphere (the "greenhouse effect"), and the increasing awareness of acid precipitation and its effects — have significantly influenced the public's perception both of science and of the interactions between politics and science. The two concerns appear at first to be disparate, but they are actually closely related: the atmospheric chemistry that leads to the production of strong acids is intimately linked to the formation and destruction of trace gases that enhance the greenhouse effect.

Interrelating important issues of public debate is particularly appropriate for a symposium honoring Walter Munk. Throughout his scientific career, Walter has sought out connections between subjects that most scientists would regard as unrelated. I have been fortunate in having collaborated with Walter on some of these ventures of integrating apparently disconnected topics into a whole.

## Introduction

Our climate is controlled by the input of solar radiation and the density and composition of the atmosphere, as well as the earth's rotation and orbit, and physical and chemical state of its surface. The average temperature of the earth's atmosphere is basically controlled by the amount of solar energy trapped within the atmosphere. If there were no atmosphere, then the average temperature of the earth's surface would be about 235°K, rather than the observed 288°K. The thermal characteristics of the atmosphere are influenced by small quantities of water vapor, carbon dioxide, ozone, and a variety of other trace constituents. The principal radiative effects of these trace atmospheric constituents are to absorb the long-wavelength, or infrared, radiation of the earth's surface and atmosphere, and to reemit the energy at the local temperature of the atmosphere. The observed warming of the surface by 35°K is due to the "blanketing" effect of the trace gases. This warming is popularly known as the "greenhouse effect", though the attribution "greenhouse" is technically incorrect, since greenhouses are heated by damping the convective heat exchange rather than radiative entrapment of heat.

The earth's thermal radiation is mainly confined to the 5 to 30  $\mu\text{m}$  region (see Figure 1). The water molecule is a strong absorber over the thermal spectrum, except in the 8 to

18  $\mu\text{m}$  interval where the earth's emission peaks. The 12 to 18  $\mu\text{m}$  region is dominated by the  $\text{CO}_2$   $\nu_2$ -(bending) mode fundamental, leaving an 8 to 12  $\mu\text{m}$  transparency window. A portion of this window is blocked by the 9.6  $\mu\text{m}$  band of ozone ( $\text{O}_3$ ). Greenhouse heating depends, therefore, on the composition of the atmosphere in several distinct ways.

As I will discuss, both carbon dioxide and ozone concentrations in the lower parts of the atmosphere are increasing. The significance of the carbon dioxide content of the atmosphere results from several considerations. Since carbon dioxide is transparent, or almost so, to sunlight but absorbs energy radiated by the earth in the infrared part of the spectrum, carbon dioxide plays a key role in determining the mean temperature of the atmosphere, its variation with height and latitude, thus the climate of the earth. The connection between climatic change and acid rain is illustrated by the role of ozone, which may play a critical role in the formation of strong acids that give rise to the acid rain phenomena.

Two relatively recent discoveries have directed attention to trace constituents other than water vapor, carbon dioxide, and ozone: first, the thermal structure of the atmosphere can be significantly affected by a number of other trace species,

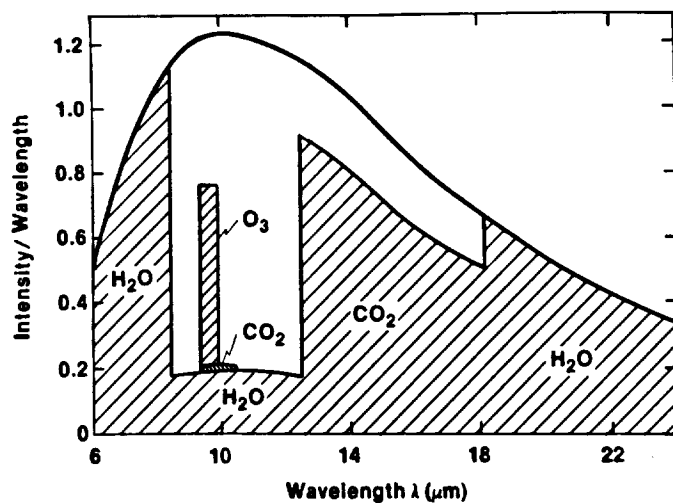

Figure 1. Thermal emission of the earth's surface at  $T = 15^\circ\text{C}$ , with relative values of the overhead absorption (integrated over the upward hemisphere) indicated by the shaded areas.



even at exceedingly low concentrations, that have long-wavelength absorption bands in the 8 to 12  $\mu\text{m}$  region; second, humans alter the chemical constitution of the atmosphere and consequently change the nature of the atmospheric greenhouse by increasing not only the carbon dioxide content but the abundance of other strong infrared absorbers in the 8 to 12  $\mu\text{m}$  interval.

More recently, it has been observed that increasingly acidic precipitation is a widespread phenomenon, not confined to Scandinavia and the Northeastern United States. Fogs and mists in Los Angeles and Bakersfield, California, have had pH values of 2.2 to 4.0 (Waldman *et al.*, 1982). ("Normal" fog and rain have pH values between 5 and 6.) In a small Scottish village, Pitlochrie, rainfall during April 1974 had pH 2.4 (Likens *et al.*, 1979). Rainfall episodes with similar high acidities also occur throughout the Eastern United States, the Sierra Nevada Range in the West, and much of Europe.

The ultimate sources of the strong acids in acid precipitation are generally considered to be emissions of sulfur dioxide ( $\text{SO}_2$ ) and nitrogen oxides ( $\text{NO}$  and  $\text{NO}_2$ , abbreviated  $\text{NO}_x$ ). These gases are released to the atmosphere by nonnuclear power plants, automobiles, smelters, and various mills, refineries, manufacturing plants, as well as home-heating units that burn coal, oil, gas, and wood. The strong sulfuric and nitric acids form when the gaseous pollutants,  $\text{SO}_2$  and  $\text{NO}_x$ , are oxidized while being transported in the atmosphere, or after absorption by surface materials. Within days, atmospheric oxygen in the presence of water converts the gases to the corresponding acids. Oxidants much stronger than oxygen would be required to oxidize more rapidly  $\text{SO}_2$  and  $\text{NO}_x$  while they are still in the atmosphere; two candidates are ozone ( $\text{O}_3$ ) and hydrogen peroxide ( $\text{H}_2\text{O}_2$ ). The concentrations of both  $\text{O}_3$  and  $\text{H}_2\text{O}_2$  depend critically on the same chemistry that affects the abundance of climate-influencing, strong infrared absorbers.

### Changing Atmospheric Chemistry and the Greenhouse Effect

The carbon dioxide concentration of the atmosphere increased by 7.2 percent between 1959 and 1980 (Keeling *et al.*, 1976, 1982), and the rate of increase accelerated with time. During the period 1958-1963, the concentration increased by 1 percent, and from 1975 to 1980, it increased by 1.9 percent, corresponding to a doubling of the rate of increase over 20 years. The increase in the concentration of atmospheric carbon dioxide is generally ascribed to human activities, particularly the burning of carbon-based fuels and the destruction of forests, though we are still uncertain of the role of oceans and the biosphere in the net carbon balance.

If the carbon dioxide concentration of the atmosphere were to double, then, as generally agreed, the average surface temperature of the earth would increase by 2° to 3°K (Clark, 1982; MacDonald, 1982a), and there would be major but largely unpredictable changes in regional climate throughout the world. Such alterations in climate are expected to significantly influence human activities, even though the prospective effects are still a subject of intellectual speculation. Unless there are worldwide and major changes in

energy usage, the  $\text{CO}_2$  content of the atmosphere will probably double during the period 2030-2080.

Major advances in atmospheric chemistry during the past ten years reveal that man-made substances other than carbon dioxide can also affect the atmosphere's thermal structure. These improvements were stimulated in large part by concern during the early 1970s that supersonic aircraft would inject such substances as nitrogen oxides and water vapor into the stratosphere, where they would reside for one or two years unless chemically transformed, and modify the ozone and aerosol content. Then it was discovered that chlorofluoromethanes, used in refrigerators and aerosol spray propellants, could also directly affect the temperature balance of the atmosphere. These compounds have long lifetimes in the atmosphere (50-100 years) and strong absorption bands in the infrared window; they affect the stratospheric ozone concentration, and increase the passage of destructive ultraviolet radiation to the surface as well as increase the surface temperature. Meanwhile, extremely powerful analytical techniques such as combined gas chromatography-mass spectrometry with single-ion monitoring were being developed; these permit one to measure trace species at a concentration of a part in  $10^{12}$  by volume.

Changes in the thermal structure of the atmosphere caused by the addition of trace gases have been estimated using one-dimensional, radiative-convective models of the atmosphere (Ramanathan and Coakley, 1978; Ramanathan and Dickinson, 1979; Lacis *et al.*, 1981). For an assumed atmospheric composition and initial temperature distribution, the local radiative heating and cooling rates are computed at each altitude. The temperature at all levels including the surface is then calculated by a numerical time-marching procedure until equilibrium is reached.

Chamberlain *et al.* (1982) estimate the change in surface temperature another way, one that does not require detailed computer modeling. First, they calculate the change in downward radiation flux at the earth's surface due to a change in concentration of a trace constituent, and then the change in average surface temperature. Using the radiative approach, they have estimated the expected changes in surface temperature caused by changes in concentrations of trace constituents. Table 1 shows their results and those of others using radiative-convective numerical models.

The greenhouse warming produced by doubling the trace constituents listed in Table 1 would increase the surface temperature by as much — 2° to 3°K — as doubling the  $\text{CO}_2$  concentration. Even though the results obtained by various investigators differ in detail, these studies employ different physical models and clearly illustrate the importance of considering trace constituent composition and concentration in any examination of our future, human-perturbed climate.

### Sources and Sinks of Trace Gases

In this section, I consider the origin and destruction of a few trace gases that participate in the formation of acid precipitation, as well as enhance the greenhouse effect (Table 1). These include nitric oxide and nitrogen dioxide ( $\text{NO}_x$ ), ozone ( $\text{O}_3$ ), carbon monoxide ( $\text{CO}$ ), and methane ( $\text{CH}_4$ ), whose abundances are related to the concentration of the hydroxyl

TABLE 1

**Changes in Surface Temperature  $\Delta T$  Resulting from a  
Doubling of Constituent Concentration**

Constituent	Compound Formula	Nominal Abundance (ppb)	$\Delta T$ ( $^{\circ}\text{K}$ )	Other Estimates of $\Delta T$ ( $^{\circ}\text{K}$ )
Ozone (total)	$O_3$	--	--	0.4 (25% increase)
Ozone (troposphere)	$O_3$	1.5	1.1	--
Nitrous Oxide	$N_2O$	320.0	0.25	0.44-0.68, ~1.1
Methane	$CH_4$	1700.0	0.95	0.20-0.28, 1.4
Carbon Monoxide	$CO$	120.0	0	
Ammonia	$NH_3$	6.0	0.53	0.09-0.12
Sulfur Dioxide	$SO_2$	0.5	0.05	0.02-0.03
Chlorofluoromethanes	$CF_2Cl_2, CFCl_3$	0.3	0.12	0.018-0.027, 0.045
Ethane	$C_2H_6$	0.05	0.09	0.01
Carbon Tetrafluoride	$CF_4$	0.06	0.004	0.04
Methyl Chloride	$CH_3Cl$	0.5	0.003	0.01-0.02
Carbon Tetrachloride	$CCl_4$	0.1	0.014	0.01-0.02

radical ( $HO$ ). Sulfur dioxide is oxidized to  $H_2SO_4$ , a strong acid in acid precipitation, but it has a minor role in the radiative chemistry related to climatic change.

Ninety percent of the total atmospheric ozone resides in the high stratosphere where it has a negligible influence on the formation of acids. In the troposphere, however, ozone is the most abundant strong oxidant. Despite its lower abundance, the radiative effect of tropospheric ozone on climate is much greater than that of stratospheric ozone, because the narrow ozone absorption lines in the stratosphere are appreciably pressure-broadened in the troposphere.

Nitric oxide and nitrogen dioxide ( $NO_x$ ) are produced by burning coal, oil, and natural gas. The principal mechanism for the formation of ozone in the troposphere involves nitrogen dioxide, which absorbs blue and near-violet sunlight and breaks apart (photolysis), forming nitric oxide and atomic oxygen:

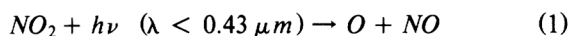

The oxygen atoms react rapidly with atomic oxygen, forming ozone:

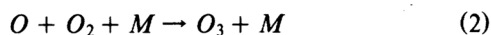

Another molecule,  $M$ , usually oxygen or nitrogen, carries off

the energy released by the formation of the new bond.  $O_3$  then reacts with  $NO$ , regenerating  $NO_2$ :

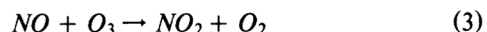

Hence the greater the abundance of  $NO_2$  relative to  $NO$ , the greater the concentration of ozone. According to reactions (1)-(3), the ozone concentration would initially increase but soon level off, and the nitrogen dioxide concentration would eventually decrease. In reality, however, the concentrations of both nitrogen dioxide and ozone have been observed to increase (e.g., on a smoggy day in Los Angeles, California). Thus  $NO$  must be rapidly converted to  $NO_2$  through other reactions in order to maintain a high ratio of  $NO_2$  to  $NO$ . The most likely candidates are the family of free radicals  $HO_x$ , particularly the hydroxyl radical,  $HO$ . A major source of tropospheric  $HO$  is due to the photodissociation of  $O_3$ :

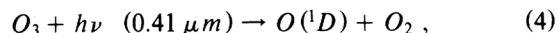

where  $O(^1D)$  is an excited form of atomic oxygen, followed by



Reactions (4) and (5) involve the destruction of ozone to form  $HO$ , but  $HO$  subsequently causes an increase in the

concentration of ozone by reacting with carbon monoxide ( $CO$ ) and catalytically converting  $NO$  to  $NO_2$ :

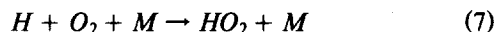

with a net effect summarized by

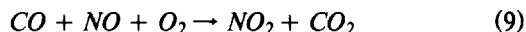

Since  $HO$  is destroyed by carbon monoxide (reaction (6)), changes in its concentration will alter the ozone concentration. Hydroxyl also destroys ozone through the reaction

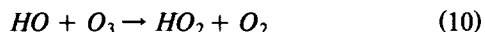

Reaction (10) is the largest sink for tropospheric ozone (Chamberlain *et al.*, 1982).

Carbon monoxide is a product of incomplete combustion of hydrocarbon fuels. The ratio of production of carbon monoxide to that of carbon dioxide averaged over the world and for all fuels is about  $3.8 \times 10^{-2}$ , suggesting that about 780 megatons of  $CO$  were added to the atmosphere by combustion during 1980. This man-made source is about equal to natural sources (Seiler, 1974).

Carbon monoxide does not directly affect the thermal balance of the atmosphere in any appreciable way, since there are no strong  $CO$  absorption lines in the 8 to 12  $\mu m$  region. Carbon monoxide (as well as methane; reaction (11)) does, however, determine in large part the atmospheric concentration of  $HO$  through reaction (6). Hydroxyl, in turn, plays a major role in determining the concentration of tropospheric ozone (and methane). A decrease in  $HO$  abundance in the atmosphere due to the burning of hydrocarbon fuels can be expected to raise the surface temperature by increasing the concentrations of both ozone and methane.

The relationship between carbon monoxide and ozone concentrations is demonstrated by the positive correlation between the two species in the height range 2-8 km (Fishman *et al.*, 1979; Seiler and Fishman, 1981). In the Northern Hemisphere, the concentrations of  $CO$  and  $O_3$  are respectively 1.4-1.8 and 1.2-1.4 times greater than those in the Southern Hemisphere. This asymmetry is due to the greater rate of fossil fuel combustion in the Northern Hemisphere, thus the greater rates of  $CO$  and ozone production, and  $HO$  destruction. The use of hydrocarbon fuels is expected to triple by the middle to latter part of the next century (MacDonald, 1982a). The added  $CO$  may be sufficient to raise the tropospheric ozone concentration by a factor of 1.5-2.0, with an expected increase in surface temperature of 0.6°-0.9°K due to the ozone alone.

Methane ( $CH_4$ ) has a strong absorption band at 7.66  $\mu m$ , so increases in its concentration can affect the surface temperature by enhancing absorption in the radiative window. If the methane concentration were to double, the surface temperature would increase by about 1°K (see Table 1).

About 500-1000 megatons of methane are added to the atmosphere each year, though we are uncertain of the exact

value of the rate. The major source of methane involves anaerobic fermentation of organic material due to microbial activity in rice paddies, swamps, tundra, as well as enteric fermentation in mammals. Mining, industrial processes, and other man-made sources add about 15-50 megatons per year (Enthalt, 1974). Humans alter methane fluxes by cultivating the rice paddies, raising livestock, and filling in wetlands.

The promiscuous hydroxyl provide the major sink for methane in the troposphere through the following reaction:

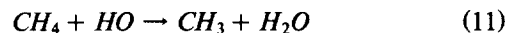

Hence the rate that methane is removed from the troposphere depends on the concentration of  $HO$ . The concentration of  $HO$  depends, in turn, on that of  $CO$ , since the principal mechanism for  $HO$  destruction is reaction (6). Methane would increase, leading to a warming, if the  $CO$  concentration were to increase due to increased usage of carbon-based fuels.

Photochemical models of hydroxyl production and destruction predict an atmospheric concentration of  $10^5$ - $10^6$  molecules per cubic centimeter, in rough agreement with recent observations (Chameides, 1978). At this concentration, tropospheric  $HO$  removes 400 to 800 megatons of methane per year. The calculated rate of destruction appears to be somewhat less than the estimated rate of production, so currently it might be expected that the methane concentration is increasing. At present, its concentration is about  $1.7 \times 10^{-6}$  by volume, and Rasmussen and Khalil (1981) show that methane is increasing at a rate of about 2 percent per year.

We can expect the methane levels to increase even further. An increasing need for agricultural products will raise the rice paddy and livestock sources, though these increases may be partially balanced by the filling in of wetlands as the demand for arable land increase.

A potential source of atmospheric methane is the large amount of carbon stored as methane hydrates in permafrost areas and oceanic sediments (MacDonald, 1982b). Methane would be released from the hydrates if the atmosphere and earth surface were to warm as a result of carbon dioxide and trace gas build-up. The initiation of methane release from permafrost areas would require centuries, since they are buried at depths of several hundred meters. The release from oceanic sediments may occur on a shorter time scale, depending on the oceans' response to a warming trend.

#### Atmospheric Chemistry of Acid Precipitation

When coal, oil, and natural gas are burned efficiently, the main gaseous effluents from the stacks are nitrogen ( $N_2$ ), carbon dioxide ( $CO_2$ ), and water ( $H_2O$ ). All three fuels also produce  $NO$  and  $NO_2$  ( $NO_x$ ), and higher temperatures of combustion (and greater efficiency) lead to higher  $NO_x$  concentrations in the effluents. Sulfur dioxide is also produced by burning oil and coal; natural gas, after customary processing, contains a negligible amount of sulfur. For oil and coal burning, about a percent of the flue gas consists of  $NO_x$  and  $SO_2$ .

Within hours of their release into the atmosphere,  $NO_x$  and  $SO_2$  are, under most meteorological circumstances, well

mixed into the thermally driven convective layer of the atmosphere. This "mixing layer" is about a kilometer thick and covers most of the land's surface.

The emitted  $NO_x$  and  $SO_2$  have a number of important sinks:

1. For the Eastern United States, flow out over the ocean, with ultimate absorption by the sea or deposition on distant continents (Europe).

2. Absorption by near or distant land or water cover.

3. Oxidation to nitrate ( $NO_3^-$ ) and sulfate ( $SO_4^-$ ) compounds, which will coalesce to form essentially dry aerosol particles in an atmosphere without water droplets. Such aerosols will be absorbed at the ground or enveloped in subsequently formed rain droplets.

4. Absorption by cloud droplets before or after oxidation to sulfuric acid ( $H_2SO_4$ ) and nitric acid ( $HNO_3$ ), subsequently producing acid precipitation. (Falling rain does not efficiently scavenge gaseous sulfur dioxide.)

Of the sulfur dioxide emitted in the United States east of the Mississippi River, about one-fifth leaves the atmosphere as sulfates, mainly as sulfuric acid, in acid precipitation falling on the United States and Canada (Calvert *et al.*, 1978; Oppenheimer, 1983). It has been estimated that approximately the same amount of sulfur dioxide is absorbed by the ground, but data on this significant sink are inadequate. The damage to lakes, forests, and materials usually associated with acid rain may also be due to the absorption and conversion of  $SO_2$  and  $NO_x$  gases, as well as absorption of dry aerosol particles at the ground.

In the Eastern United States, nitric acid is, at present, a considerably smaller contributor to the  $H^+$  content of rain than is sulfuric acid. This is partially due to the fact that each sulfate ion in aqueous acid solution supports two  $H^+$  ions, while aqueous nitric acid contributes only a single  $H^+$ .

#### Oxidation Rates of Sulfur Dioxide and Nitrogen Oxides

Table 1 lists typical concentrations of  $SO_2$  and  $NO_x$  in the mixing layer far from strong individual sources, as well as some typical oxidant concentrations. As noted earlier, hydroxyl forms through the reaction of  $O(^1D)$  with water molecules (reaction (5));  $HO$  is very reactive and serves as a precursor for  $HO_2$  and ( $H_2O_2$ ).

The trace gases discussed in connection with climatic change determine, in part, the conversion of  $SO_2$  and  $NO_x$  to sulfuric and nitric acids. Their role in this conversion is considered next.

In the oxidizing mixing layer,  $NO_x$  is quickly converted to nitric acid:

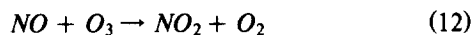

Reaction (12) proceeds rapidly, in about  $10^3$  seconds, while (13) takes about 6 hours. Since nitric acid is very soluble in water,  $NO_x$  can be converted to nitric acid within a fraction of a day when water droplets are present. Notice that the conversion of  $NO_x$  to nitric acid depends on the presence of the free radical  $HO$  (reaction (13)), which, as shown earlier, enters into a variety of reactions with strong infrared absorbers.

The gaseous, in contrast to the aqueous, oxidation of sulfur dioxide to sulfuric acid is much slower than the conversion of  $NO_x$  to nitric acid. For example, the following reactions typically take about 100 hours, though in a highly polluted atmosphere the reaction rate is about 10 times as rapid:

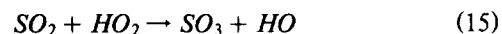
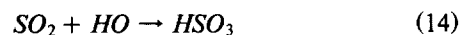

This slow rate of conversion indicates that other mechanisms involving aqueous phase oxidation are significant.

An examination of both the relative oxidation rates in the gaseous phase of  $SO_2$  and  $NO_x$ , and of the abundances of effluents and oxidants listed in Table 1 lead to the following points:

1. The abundances of oxidants in the mixing layer far from polluted urban areas are approximately equal to those of emitted  $SO_2$  and  $NO_x$ . Under conditions of long residence times and/or high rates of oxidation, it is difficult to predict whether the amount of strong acids formed would be limited by the abundance of oxidants or the abundance of effluents. The development of a control strategy based on limiting only effluents,  $SO_2$  and  $NO_x$ , is highly risky owing to the uncertainty of the limiting factor in the formation of strong acids.

2. In general,  $NO_x$  will be oxidized to  $HNO_3$ , ready to be absorbed in droplets, before  $SO_2$  is oxidized to  $H_2SO_4$ . Rainout of  $HNO_3$  can begin prior to  $H_2SO_4$  rainout. In a situation where oxidizers are limiting, the  $HNO_3$  can use up the available oxidant before all the  $SO_2$  is converted to  $H_2SO_4$ , thus suppressing the amount of  $H_2SO_4$  that would otherwise form. The occurrence of early  $HNO_3$  rainout is supported by European observations, where the ratio  $HNO_3/H_2SO_4$  in precipitation progressively decreases with downwind distance from the strongest sources (Rodhe *et al.*, 1981).

#### Limits to the Deposition of Sulfuric Acid in Precipitation in the Eastern United States

Most of the sulfur dioxide emitted in the Eastern United States results from the burning of coal and oil under boilers generating electricity. In this region, there are no significant seasonal variations in fuel use, because the heating needs during the winter are replaced by air conditioning in the summer (regional variations in fuel use do occur). There are, however, strong seasonal variations in the acidity and sulfate content of precipitation. The acidity is greater in the summer than in winter. Significantly, the ratio  $SO_4^-/SO_2$  shows an even stronger seasonal variation, with the value highest during the summer (Henderson and Weingartner, 1980; Galloway and Likens, 1981). These data suggest that  $SO_2$  is more efficiently oxidized to  $SO_4^-$  during the summer. However, there are no significant seasonal variations in the conversion of  $NO_x$  to  $NO_3^-$ .

The seasonal variations can be explained in part by changes in the behavior of the mixing layer, but there remains the problem of seasonal differences within it (Chamberlain *et al.*, 1983). The strong oxidants are mainly photochemically induced (see reactions (1), (2), (4), (5) and

(10)), and strong seasonal variations in oxidant concentrations are observed, with higher levels during the summer (National Research Council, 1977).

From these considerations, it appears that the acidity and  $SO_4^-$  concentration of rain in the Eastern United States are limited during the winter by the amount of oxidant available rather than the quantity of sulfur dioxide emitted. This is consistent with the lack of seasonal variation in  $NO_3^-/NO_x$ . The conversion of  $NO_x$  to nitric acid occurs much more rapidly than the transformation of sulfur dioxide to sulfuric acid, implying that  $NO_x$  uses up the available oxidant before sulfur dioxide can be oxidized. In the summer, oxidant levels are sufficiently high so that the amount of  $SO_2$  in the atmosphere is the limiting factor in the formation of acid.

The role of oxidants in governing  $SO_4^-$  formation in Europe appears to differ from that in the Eastern United States. In Europe, oxidant concentration does vary seasonally (as in the Eastern United States), but the precipitation tends to be more acidic in the winter than in the summer. The total deposited acid precipitation follows the seasonal variation in fuel use in Europe (greatest fuel use in winter, lowest in summer), so it would seem that the availability of sulfur dioxide is the limiting factor in determining the amount of sulfuric acid deposited in Europe.

#### Strategies for Reducing Acid Precipitation

Strategies for reducing acid precipitation would depend on the answers to two questions:

1. Is the oxidation of sulfur dioxide to sulfuric acid in precipitation limited mainly by the amount of oxidant available?
2. Does  $NO_x$ , which eventually rains out as nitric acid, also catalyze the production of more oxidant than it consumes in the smog formation process?

Answers to these questions will be different for different regions and seasons. In Europe, for example, the answer to question 1 appears to be "no" — a reduction in sulfur dioxide should result in a comparable reduction in acid precipitation. Indeed, this hypothesis may have been tested in the Netherlands between 1968 and 1976 when coal and oil were replaced by natural gas, which has a negligible sulfur content. The reduction was accompanied by a reduction in the  $H^+$  concentration in rain (Vermeulen, 1979).

In the Eastern United States, we would expect a similar result of reducing sulfur dioxide emissions only when and where oxidant concentrations are sufficiently high, or where  $SO_2$  and  $NO_x$  emissions are sufficiently low that their conversion to acids is not limited by the amount of oxidant available. For this region, at least during the winter, a reduction in sulfur dioxide emissions may not result in a comparable decrease in deposited acid. This hypothesis may have been tested inadvertently during 1979 when a strike closed down the Sudbury, Ontario, nickel smelter, the world's largest single source of sulfur dioxide. There was no evidence of an effect on either the  $SO_4^-$  or  $H^+$  concentration in the downwind precipitation (Chamberlain *et al.*, 1983).

An appropriate strategy for limiting the mixing layer oxidizers is probably not very sensitive to the chemical details of exactly which oxidizers are involved and how they act. A variety of arguments based on reaction rates and isotopic

ratios suggest that the principal oxidation path involves the oxidation of  $SO_2$  within water droplets by hydrogen peroxide ( $H_2O_2$ ) (Oppenheimer, 1983; Penkett *et al.*, 1979; Chameides and Davis, 1982). Therefore a strategy for reducing the oxidizers would be one that would limit  $H_2O_2$  in mixing-layer droplets. A precursor of  $H_2O_2$  is  $HO_x$ :

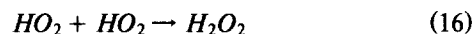

As shown previously,  $HO$  is, in turn, formed by excited oxygen atoms photoliberated from ozone (reactions (4)-(7)), but  $HO$  is destroyed by carbon monoxide and methane (reactions (6) and (11)). Therefore, a reduction in ozone would aid in the reduction of acid-forming oxidizers. In regard to this, the emissions of  $NO_x$  may be critical (see question 2 above).  $NO_x$  can be a sink for oxidants through

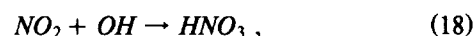
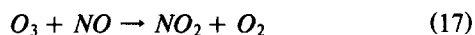

as well as a source, since  $NO_2$  rapidly photodisintegrates in sunlight and the freed oxygen atoms form ozone (reactions (1) and (2)). Thus any transformation of  $NO_x$  to  $NO_2$  that does not utilize  $O_3$  can result in additional  $O_3$  and restored  $NO_x$ . If such a catalyzed smog production did not take place, then an increase in  $NO_x$  emission that resulted in only oxidant reduction would reduce both the  $SO_4^-$  and  $H^+$  concentrations in precipitation by using up enough of the oxidizer.

In summary, reducing sulfur oxides alone may not reduce the acidity of precipitation, at least during the winter, in the Eastern United States. It should be noted, however, that in considering the overall damage due to air pollution, reducing sulfur dioxide emissions alone may be critical; damage may not only be associated with wet precipitation but also with dry deposition of sulfur dioxide.

#### Concluding Remarks

The preceding discussion illustrates some of the connections, owing to the complexity of atmospheric chemistry, between acid rain and the greenhouse effect. Numerous questions, some having major policy implications, remain open. For example,

1. Reducing carbon monoxide emissions will stabilize or increase the concentration of  $HO$  and, in turn, increase the atmospheric sink for ozone and methane. At the same time, increased  $HO$  concentrations will lead to a higher rate of hydrogen peroxide formation, which in turn can enhance oxidation of  $SO_2$  to  $SO_4^-$ . The increase in the sink for methane and ozone would help alleviate the greenhouse problem, but an increase in  $HO$  concentration may lead to greater acid precipitation. On balance, what steps should be taken in view of the implications of changing the  $HO$  concentration for both acid rain and climate change?

2. What are the consequences of limiting  $NO_x$  effluents to both the acid rain and climate change problems?  $NO_x$  emissions lead to the production of nitric acid through the destruction of hydroxyl, thus inhibiting sulfuric acid formation. But  $NO_x$  also produces ozone, which can influence climate as well as lead to strong acid-forming oxidants.

The answers to these and related questions will result only from a far more complete understanding of the complex problems of atmospheric chemistry. In any analysis of atmospheric processes, it is essential that the interrelationships of the various mechanisms be clearly understood, as well as their applicability to the solution of key policy questions. This is a task that Walter Munk, in so many other areas, has undertaken with great success.

**Acknowledgements.** Over the past few summers I have been part of a JASON group which has looked into problems of climate change and acid rain. Participants included Joseph Chamberlain, Malvin Ruderman, and the late Henry Foley. Their work forms the basis of this paper. I also thank Stefana Matarazza for her helpful criticism of the manuscript.

#### References

- Calvert, J., F. Su, J. Bottenheim, and O. Strauz. 1978. Mechanism of homogeneous oxidation of sulfur dioxide in the troposphere. *Atmos. Environ.*, **12**, 197.
- Chamberlain, J., H. Foley, G. MacDonald, and M. Ruderman. 1982. Climate effects of minor atmospheric constituents, in *Carbon Dioxide Review: 1982*, pp. 255-277, edited by W. Clark, Oxford University Press, NY.
- Chamberlain, J., G. MacDonald, and M. Ruderman. 1983. Overview of the physical-chemical processes in the formation of acid precipitation. *JASON Technical Report JSR-82-301A*, The MITRE Corporation, McLean, VA.
- Chameides, W. 1978. The photochemic role of tropospheric nitrogen oxides. *Geophys. Res. Lett.*, **5**, 17.
- Chameides, W., and D. Davis. 1982. The free radical chemistry of cloud droplets and impact on the composition of rain. *J. Geophys. Res.*, **87**, 4853.
- Clark, W. (editor). 1982. *Carbon Dioxide Review: 1982*. Oxford University Press, NY.
- Enthalt, D. 1974. The atmospheric cycle of methane. *Tellus*, **26**, 58.
- Fishman, J., V. Ramanathan, P. Crutzen, and S. Liu. 1979. Tropospheric ozone and climate. *Nature*, **282**, 818.
- Galloway, J., and G. Likens. 1981. Acid precipitation: The importance of nitric acid. *Atmos. Environ.*, **15**, 1081.
- Henderson, R., and K. Weingartner. 1980. Analysis of MAP3S precipitation chemistry data. *Technical Report MTR-80W00265*, The MITRE Corporation, McLean, VA.
- Keeling, C., R. Bascatow, A. Bainbridge, C. Eckdahl, P. Guenther, L. Waterman, and J. Chin. 1976. Atmospheric carbon dioxide variations at Mauna Loa Observatory, Hawaii. *Tellus*, **28**, 538.
- Keeling, C., R. Bascatow, and T. Wharf. 1982. Measurements of the concentration of carbon dioxide at Mauna Loa Observatory, Hawaii, in *Carbon Dioxide Review: 1982*, edited by W. Clark, pp. 377-385.
- Lacias, A., J. Hansen, P. Lee, T. Mitchell, and S. Lebedeff. 1981. Greenhouse effect of trace gases, 1970-1980. *Geophys. Res. Lett.*, **8**, 1035.
- Likens, G., R. Wright, J. Galloway, and T. Butler. 1979. Acid rain. *Scientific American*, **241**, 43.
- MacDonald, G. 1982a. *The Long-Term Impacts of Increasing Atmospheric Carbon Dioxide Levels*. Balinger, Cambridge, MA.
- MacDonald, G. 1982b. The many origins of natural gas, in *Deep Source Gas Workshop Technical Proceedings*, edited by W. Gwilliam, pp. 17-47, U.S. Department of Energy, Morgantown, West Virginia.
- National Research Council. 1977. Atmospheric concentrations of photochemical oxidants, in *Ozone and Other Photochemical Oxidants*, Committee on Biological Effects of Environmental Pollutants, National Academy of Sciences, Washington DC.
- Oppenheimer, M. 1983. The relationship of sulfur emission to sulfate precipitation. *Atmos. Environ.*, **17**, 451.
- Penkett, S., B. Jones, K. Brice, and A. Eggleton. 1979. The importance of atmospheric ozone and hydrogen peroxide in oxidizing sulfur oxide in cloud and rain water. *Atmos. Environ.*, **13**, 123.
- Ramanathan, V., and R. Dickinson. 1979. The role of stratospheric ozone in the zonal and seasonal radiative energy balance of the earth's troposphere system. *J. Atmos. Sci.*, **36**, 1084.
- Ramanathan, V., and J. Coakley. 1978. Climate modeling through radiative-convective models. *Rev. Geophys. Space Phys.*, **16**, 465.
- Rasmussen, R., and M. Khalil. 1981. Atmospheric methane ( $CH_4$ ): Trends and seasonal cycles. *J. Geophys. Res.*, **86**, 9826.
- Rodhe, H., P. Crutzen, and A. Vanderpol. 1981. Formation of sulfuric and nitric acid in the atmosphere during long-range transport. *Tellus*, **33**, 132.
- Seiler, W. 1974. The cycle of atmospheric  $CO$ . *Tellus*, **26**, 116.
- Seiler, W., and J. Fishman. 1981. The distribution of carbon monoxide and ozone in the free troposphere. *J. Geophys. Res.*, **86**, 7255.
- Vermeulen, A. 1979. The acidic precipitation phenomenon. A study of this phenomenon and of a relationship between the acid content of the precipitation and the emission of sulfur dioxide and nitrogen oxides in the Netherlands, in *Polluted Rain*, edited by T. Toribara, M. Miller, and P. Morrow, Plenum Press, NY.
- Waldman, J., J. Manger, J. Jacob, D. Flagan, R. Morgan, and M. Hoffman. 1982. Chemical composition of acid fog. *Science*, **218**, 677.

# NOTES ON THE GENERAL CIRCULATION OF THE OCEANS

Peter B. Rhines

*Woods Hole Oceanographic Institution  
Woods Hole, Massachusetts 02543*

The decades which coincide with Walter Munk's professional career contain, not by chance, some remarkable advances in our view of the large-scale ocean circulation.

Now, in 1982, we are living in such a rapidly changing world that we tend to assume that farther in the past, oceanography was moving at a pokey pace. We notice ocean and atmosphere models converging and anticipate new interdisciplinary adventures ahead. The past ten years have indeed seen remarkable advances in our descriptive, theoretical and experimental pictures of the oceans. But much of volume VII of the *Journal of Marine Research* is an "appreciation" to H.U. Sverdrup, on his 60th birthday, which reminds us otherwise. The occasion, fortunately not being duplicated at these proceedings, was Sverdrup's departure from Scripps, to return to Arctic research in Scandinavia. He had been here 12 years, a short time, yet consider what had occurred during that period, 1936-1948: the end of the Depression, World War II, the beginning of the nuclear age, jet aircraft, television, electronic computers. To our science came the discovery of the quasi-geostrophic equations and potential vorticity, and Rossby's  $\beta$ -plane (where many of us now live). The Sverdrup balance and the closure of the general circulation with western boundary currents finish out this remarkable marathon. Oceanography and meteorology were delightfully mixed together in the few journals that existed. Thus despite the smallness of the community of scholars, the lack of public (and university) understanding that this is a rational, deductive science, the intervention of the War, and the absence of modern electronics (both in instruments and computers), oceanography had moved light years ahead.

In case further proof of the vitality of this period is needed, let me list some of the names that appeared in that single "Sverdrup" issue of *JMR*: Bigelow and Schroeder, Jakob Bjerknes, Eckart, Emery, Fleming, Iselin and Fuglister, Haurwitz, von Karman, Ketchum, Knudsen, Munk, Redfield, R.O. Reid, Riley, Rossby, Spilhaus, Starr and Platzmann, Stommel, and Woodcock! By the measure of numbers it was a small field, but it must have been exciting company.

Now it is time to describe some of the ideas that govern the large-scale circulation. Without denying that important pieces of the puzzle were understood by some before the middle of this century, it is clear that the post-1945 era has seen vast progress. Great and simple are words that describe

effective science: what is sought is the simplicity that may lie everywhere beneath the complicated flow of the oceans. The physical laws are known in a microscopic sense, but the whole problem of a fluid environment is one of integration: the sometimes disparate local physical laws must combine into a harmonious and reasonably accurate global solution.

Subsequent to the discovery of the basic equations of motion and the potential vorticity principle, the following fluid dynamical ideas have occupied key positions: the stiffness of rotating fluids; the role of boundary layers in circumventing the problems created by this stiffness; the role of Rossby waves in describing the set-up of the circulation, and hence in determining a unique solution; the role of energetic, moving eddies in determining the general circulation, and, the conservative nature of the fundamental variables, potential density and potential vorticity.

The first of these ideas is that rapidly rotating planets like the Earth endow their fluids with a certain rigidity. For ocean currents that change but little over tens of kilometers and over a day, the planet seems to spin rapidly indeed. Taylor and Proudman in 1921 recognized that this property tends to cause unstratified fluid to move in undeformed columns aligned parallel to the rotation axis. This puts severe constraints on the kinds of flow that can occur; picture the fluid on a spherical earth trying to move north or south, for example. The distance, parallel to the rotation vector  $\Omega$ , between the surface and the bottom varies with latitude, since it is the radial separation that is constant in a spherical shell. Simple flow to the north or south would force the length of the fluid column to change. The implication is that flow of homogeneous fluid on an idealized sphere would prefer to run purely east-west. Very unlikely indeed, if continents lie in the path of such flow, tending to make the circulation vanish altogether.

But, these are not free flows. They are driven, in part, by winds above the sea surface. They cause a boundary-layer flow in the upper few tens of meters of the ocean which, through its own mass imbalance, forces fluid down into the deeper ocean. Now the idealized picture of the circulation is just that of a very stiff fluid (in directions parallel with  $\Omega$ ) moving about so as to avoid being squashed by the vice created by the wind-driven downward motion near the sea surface. The simple large-scale vorticity equation

$$\beta v = f \partial w / \partial z$$

is just an expression of the conservation of the length, projected on  $\Omega$ , of these fluid line segments. Many of us refer to this as a Sverdrup balance, even though Sverdrup's most famous contribution is related to the vertical integral of this equation. For the homogeneous-density fluid we are discussing, it turns out that  $\partial w / \partial z$  is just  $w(\text{surface})/H$ , where  $H$  is the ocean depth, so that this becomes a simple linear relation between the two velocity components,

$$v = (f/\beta H)w$$

Just, in fact, what one has with a wedge-like inclined plane, one of the "simple machines" of elementary mechanics.

Thus we find that the large-scale circulation is in a sense not a very fluid thing at all, but is the very constricted motion north or south of a rigid material trying to escape the stretching or squeezing forced upon it by the atmospheric winds. The ensuing horizontal velocity is perhaps 5000 times as great as the vertical velocity that created it, for the same reason that squeezing a rigid grape pip causes it to fly off at a speed much greater than the velocity at which your thumb and finger come together.

The strange properties of this planetary fluid were beginning to be understood by Lamb and Hough in theoretical models late in the last century. Proudman and Taylor used dramatic laboratory experiments to demonstrate the anisotropy put into the fluid by planetary rotation. More recently we have come to put the pieces together, and see how intuitively simple is Sverdrup's relation between wind-driving ( $w$ ) and response (the circulation,  $v$ ). I have dwelt on this keystone in order to point out the strange slowness of scientific progress: from the first glimmer of the idea to the execution, and finally to the infiltration in the minds of the oceanographic "public" (if, indeed, it has reached that stage) has taken perhaps 80 years and the accurate transmittal of ideas across a tenuous network of science: across coffee rooms, the pages of a few journals, and the span of a few classrooms. For this shaky transmission line to work, we rely on the stability of a few centers of excellence, where the evolving principles of the science are kept shiny.

All of this leads us to another apparent paradox: the winds between about  $15^\circ$  and  $40^\circ$  latitude drive the oceans with a downward vertical velocity ("pumping") throughout. Sverdrup's relation would require southward circulation throughout this band, which would pile up the water near the Equator. To get the water back poleward, something has to give. By concentrating itself into a thin, fast stream, the excess mass can return northward in the "shelter" of the coast, by violating the "slow, large-scale" assumption built into the Sverdrup relation, above.

This is where the events of 1947-50 become so exciting. We look back on the three papers of Sverdrup (1947), Stommel (1948) and Munk (1950) as the formulation of the two branches of the wind-driven circulation: the Sverdrup interior and the western boundary currents. While the score in this game would seem to be Scripps 2, Woods Hole 1, we might as an alternative invoke the sandwich analogy!

I think, however, that reading these papers gives us a sense of three diverse talents illuminating three complemen-

tary aspects of the circulation. The power of Sverdrup's paper is that it gives us the vertically integrated circulation as a function of the wind-stress distribution, regardless of the presence of density stratification. Stommel takes a more idealized homogeneous fluid with a special bottom friction, and manages to close the entire circulation with a frictionally controlled western boundary current. The craft in this heavily simplified model of the ocean was in knowing what to leave out. Without literal justification, Stommel could pose a model containing some of the known physical effects, and come up with a prediction of boundary currents far more general than the narrow model used to derive them, and in nature more numerous than the Gulf Stream or Kuroshio. Munk's paper adds yet another aspect: the beginnings of the whole system of wind-driven gyres (beyond just the subtropical gyre), in oceans of more realistic shape, the beginnings of their actual three-dimensional (rather than barotropic) structure, and the presence of a different kind of friction. One senses here a drive, which is clear in his later works, to take a heavily idealized model and plunge it into the wet, funny shaped ocean, to see if it manages to swim.

I think in hindsight we can say that beneath these individual models lie general principles growing from Rossby's work on wave motions, and from turbulence theory. Low-frequency information is normally transmitted by Rossby waves to the west on a rotating planet (a point clarified by Lighthill in an energetic survey lecture on rotating fluids given in IGPP's splendid lecture room in 1966). This sends the imbalance of mass to the western boundary, where some sort of boundary layer — frictional, inertial or topographic — forms up to carry the fluid back northward. The technique suggested by this result is familiar to any amateur mechanic: if you don't understand a steady circulation (or recalcitrant motor), try turning it on and off a few times. By watching the circulation develop from rest, we have a clearer idea of who is doing what to whom.

Turbulence theory further generalizes this picture, showing us that oceanic fluid moving near a western boundary inescapably increases the enstrophy, or squared vorticity, of the ocean. The enstrophy can be thought of as small-scale energy, and so we have a stochastic prediction for an ocean in arbitrarily chaotic motion, that small-scale intense flow must be expected near the western boundary. In any case, the global sense of the wind-driven circulation is that the wind puts anticyclonic potential vorticity into the fluid in the sub-tropical latitudes, and as the fluid returns poleward it sheds this potential vorticity ultimately to friction, hence allowing a statistically steady state to exist.

It would be terrible to give the impression that this problem is now wrapped up and put away. ("I detest 'facts'. They denote ideas about which all investigation has ceased, and by tacit agreement there will be no further inquiry.") I would not be totally surprised, for instance, if some clever new observations were to show us that the 'braking' of the circulation in the western boundary region were by wave drag as the fluid flows over rough bottom topography, rather than by the frictional retardation assumed in the classical models. P. Richardson's observations of the frightening effect of the New England Seamounts on the Gulf Stream overhead, stimulate such thoughts.



A sense of progress is clear, however. I doubt if we are about to be overthrown by one of Thomas Kuhn's scientific revolutions, nor do I think that we are being slavish to old and shaky paradigms. The combination of clear thinking and love for the natural seas seems to give a peculiarly orderly march of our science. Nevertheless, dramatically simple underlying structures in the general circulation may still be before us. If they unify our thoughts with anything like the power of plate tectonics and modern "geodynamics", or the power of the western boundary currents and stiff interior given us by the "three horsemen" of 1947-50, then an exciting future is assured.

The next event I want to describe is the mesoscale eddy. That is the name given to the most energetic of transient large-scale currents, roundish patterns of flow 100 km or so in breadth. Although anyone looking at the circulation closely was aware of its unsteadiness, the new view that matured in the 1970's was of the essential role of these eddies to the general circulation in which they are imbedded.

Now, it must be realized how contrary to the spirit of classical oceanography these eddies are. Oceanographers are sometimes people of few words, patient enough to survey the seas with a slow ship, a few Nansen bottles and a cantankerous winch. It may take them a lifetime to fill in the picture of the circulation from innumerable cruises, all combined as one, as if the ocean were standing still for a Daguerrreotype.

The need for synoptic pictures of a time-varying ocean clearly strains our modest resources to the limit. By comparison the meteorologist is rolling in data, because his energy-containing eddies are ten times bigger than ours, and are easily mapped with barometers located in the major cities. This is the point to introduce another remarkable aspect of Walter Munk's career: his commitment to developing and using new measurement techniques in the face of hostile complexity.

The Mid-Ocean Dynamics Experiment in 1973 was a concerted attack on the mesoscale eddy. Walter and Frank Snodgrass had for some years prior to this been developing the technology of self-contained capsules of instrumentation. After using them to look at tidal fields and explore the "ideal, technician-free" environment of the deep sea, they joined a remarkable group of innovative instrumentalists on a common playing field in the mid-Sargasso Sea. I think more than "testing an idea" or mapping a field, the MODE experiment was like the frolicking of unbroken horses in a spring pasture. The moored and drifting instruments, careening airplanes, and the racing hydrographic fleet were given their head. Despite all attempts at organization and management, the investigators worked largely as individuals, and I think the marvelous, moving picture of a few mesoscale eddies was a wonderful fortuitous result. Other products of the experiment, like Bill Richardson's melodrama "I'm in the MODE for Love" (starring Nelson Eddy and Mary Baker Eddy) show some of the heady spirit that focused on the Bermuda Hot-Line Center.

It was the first major test of such remarkable devices as Rossby and Webb's SOFAR floats, Sanford's velocity profiler and (with respect to long-period motions) the bottom pressure gauges. The bottom-capsule group in MODE found

remarkably large-scale fast pressure waves which may have been a first look at the grave-mode planetary modes of the North Atlantic. Such modes, recently documented by Luther in the Pacific, have long been suspected, but not clearly seen before this time. Because pressure is a naturally low-passed filtered (in space) version of velocity, the bottom capsules saw this different regime of "eddy" that is more or less invisible to the current meters.

Since this decade of eddies, many have been revisiting the general circulation, armed now with considerably more firepower than was available to the pioneers. We have seen how inescapably strong is the transmission of momentum by eddies, both sideways (by Reynolds' stresses) and, with even greater strength, *downward* through the water column (by a generalized wave drag). Summed up as an eddy transport of potential vorticity, these tiny agents are responsible for carving out the great bowl-shapes of the wind-driven gyres.

Knowingly or unwittingly, all of us who try to model the general circulation are working with conservation principles for the potential density and potential vorticity. Granted this, it is surprising that so much effort has gone into mapping the density field, yet so little into mapping the potential vorticity. David Behringer, working here with Myrl Hendershott, produced maps of South Atlantic potential vorticity in 1972, from data of the 1927 Meteor Expedition. These and later maps and theories have shown that the potential vorticity, being nearly conserved on potential density surfaces, is greatly deformed by the circulation (relative to the ambient north-south gradient,  $\beta y$ , found in a resting ocean). Theoretical arguments had suggested that, in fact, we might find the great wind-gyres to spin so unremittingly that the potential vorticity would form a great homogeneous pool within them. Recently constructed maps show this to be the case. In the maps we can clearly see the injection of new water masses from the sea surface and from the "edges" of the gyres, the apparent internal equilibrium of uniform potential vorticity that takes over, and the relatively small influence apparent from the western boundary currents. Soon we may have yet another level of understanding of these "Gulf Streams" and their role in the general circulation; a first impression is that the boundary currents are either acting as mixing valves for the potential vorticity, or else leaving it entirely alone (as in an inertial boundary layer). The prospect of a strong input of potential vorticity from the coasts, through lateral friction, would seem to color the interior ocean field more than the maps show it to be colored.

Most of these remarks have dealt with the mechanical aspects of the circulation: for example, the development of a wind-spun gyre upon a pre-existing basic fluid stratification. Lying ahead is a much more difficult problem: the determination of the basic temperature and salinity fields themselves, in response to heat and moisture fluxes at the sea-surface. This is the "1000-year" problem which will strain to the limit our computers, our observations, and our minds. Characteristic of the problem is the need to know both the dynamics of the largest, planetary scale, and the mixing rates at the scale of centimeters. Walter's paper "Abyssal Recipes" 16 years ago analyzed the role of these crucial mixing events, and provided stimulus to micro- and macro-scale research,

alike. The ingenious fine- and microstructure measurements carried out since that paper was written have showed us much of the inner workings of vertical mixing, but have not altered its basic conclusions.

This talk about mixing of temperature and salinity and the conservative nature of potential vorticity brings up a subject of intense activity: "Lagrangian tracers". A vast range of natural and artificial trace chemicals in the seas move with the water, with little change. They thus act as sensitive indicators of the general circulation. We see plumes of tritium diving from surface to sea floor in the high-latitude North Atlantic, and streaming southward along the western boundary. The nutrients, dissolved oxygen, Freons, radiocarbon, salinity and many other substances give us many independent pictures of the ingestion of waters into the deep sea from its surface and sides. Measurement and interpretation of the global patterns of these chemicals is both telling us how the circulation works dynamically, and answering socially-relevant questions about the ability of the sea to take up excess carbon dioxide and pollutants.

A subject like Lagrangian tracers provokes numerous pairwise interactions: chemists and physical oceanographers, dynamical models and kinematic models of the circulation, seagoing measurements and model calculations. We find it exciting, for example, that a simple idea like the shear-augmented diffusion of a trace chemical in a specified flow, leads us to a better understanding of the determination of that key *active* tracer, the potential vorticity: a tracer which "distorts itself".

That is all I have to say about the general circulation, except for this little reminder: the general circulation is not a well-defined idea! Even though we can measure accurately the velocity of the water with a current meter, and construct a map of it, it would not, in general, tell us where the water goes on average (i.e., the Lagrangian circulation). The two separate effects of mean flow and mixing in the Eulerian frame become intermingled into the "mean flow" in the Lagrangian frame. The problem is far deeper than that which we encounter with the simple Stokes-drift correction, which links the two kinds of mean velocity beneath a periodic surface wave. The energetic nature of mesoscale eddies means that the dispersion of marked fluid away from the Lagrangian-mean trajectory is often so great as to render the mean value useless, and Stokes-drift corrections senseless.

Inevitably, we seem to be forced back to massive spatial averaging of the circulation before these difficulties begin to go away. It is in this sense that the new, specially integrating measurements have so much promise: the instrumentalists are about to present us with another kind of "mean circulation", for example from reciprocal acoustic transmissions

averaging over paths as long as 1000 km, an idea put forward by Rossby and now being pursued by Munk and Wunsch. A wonderful aspect of oceanography is the way people measure things that no one knew they wanted measurements of. Subsequently, the serendipity of instrument builder and analyst often combine to find a dramatic use for such new data (Rossby's measurements of temperature on a drifting isobaric float being one example: they tell you the mesoscale vertical velocity!).

With the lineage of oceanography deriving so directly from polar exploration, I cannot omit saying how important our seagoing lives are to us: even to theoreticians who are allowed aboard only if they promise not to touch anything. Although I have not been to sea with him, I know how Walter loves a good cruise.

Oceanographers are not (and probably could not be) algebraic topologists or some equally abstract characters. The natural world, with its lively diversity riding upon simple principles, gives them back something extra. They pose a theory and go looking. The theory is probably wrong. But it suggests a way of seeing into a maze of data. The blip on the mathematical radar scope is round and bright, but see how it looks up close. The blip I am remembering was on Capt. Hiller's radar on the R/V *Knorr*, shortly after we emerged from a fjord at Cape Farewell, Greenland, into the Labrador Sea. After a cautious approach, a veil of mist suddenly rose to reveal a cathedral of ice in front of us. Waterfalls cascaded from its white cliffs, streaks of blue crossed it, the old strata lay at a strange inclined angle, recording Victorian volcanoes. In the middle there was a turquoise lake. Kittiwakes, puffins, and jaegers roosted on its glazed flanks. Things beyond our wildest dreams given back for simple curiosity, a round blip becomes a Norse Mermaid. Finally, after we cruised round it several times and thought that was all, someone said, "Did you forget, 9/10 of it is still below?"

The happiest conclusion to be made is not really about the general circulation, but about the way it is pursued. Granted that the ocean itself is always so much more beautiful than our early vision of it, we become better friends and better shipmates. The senses of humor, generosity, and curiosity are as necessary as incisive analysis. The community and tradition that these produce are vital to progress. I think this is Walter's greatest single contribution, the creation of an invisible network spanning the vast range of research that you see in this symposium. He does this not with the pushing of an administrator, but with the pull of ingenious ideas. Even rarer than a good scientist is a good scientist who can enthuse and persuade.

# HULA DANCERS, WALTER MUNK AND THE ROTATION OF THE EARTH

Kurt Lambeck

*Research School of Earth Sciences  
Australian National University  
Canberra ACT Australia*

"Let the great world spin for ever down the ringing grooves of change"

Lord Tennyson, 1842

Lewis Carroll was correct when he wrote "If everybody minded their own business, the world would go round a deal faster than it does." For unnatural acts like hula dancers performing at the north pole or New England vacationers driving to Florida, do modify the Earth's rotation. At least Walter Munk would have had us believe this.\* Other people, such as Johnny Hart, have also appreciated the finer aspects of the Earth's rotation (Figure 1).

Astronomers measure the rate of rotation of the Earth and the direction of the rotation axis relative to the crust. If the instantaneous rotational velocity is denoted by  $\omega$  and a mean velocity by  $\Omega$  then  $\omega = \Omega(1+m)$  where  $m$  is a small quantity specifying the departure from uniform rotation. What astronomers observe is not  $\omega$  or  $m$  but the amount  $\tau_{\Delta T}$  by which the Earth is slow after an interval of  $\Delta T$  days. This is effectively done by observing the successive instants of transit of a star across a meridian against a uniform time scale. Then

$$m = \frac{(\omega - \Omega)}{\Omega} = \frac{-d\tau}{dt} = \frac{d}{dt} (UT - AT) = \frac{-\Delta(\text{l.o.d.})}{\text{l.o.d.}}$$

where  $UT$  is universal time kept by the Earth,  $AT$  is the atomic time, l.o.d. is the length-of-day and  $\Delta(\text{l.o.d.})$  is the change in length-of-day.  $m$  is typically of the order 1 in  $10^8$ . Changes in  $m$  may approach 1 part in  $10^7$  over periods of

several decades (see Figure 2). Figure 3 illustrates the main characteristics of the length-of-day spectrum.

The direction of the instantaneous rotation axis is determined from the measurement of the zenith angle  $z$  of stars of known declination  $\delta$ , since at transit the latitude is given by  $\phi = \delta \pm z$  with the sign being a function of whether the star transits below or above the celestial pole. If the position of the rotation axis shifts relative to the observer's vertical, this will be reflected by a comparable change in the zenith distance next time the star transits. Observations of the "changes in latitude" from several stations determine the motion of the rotation axis. This is the polar motion. Figure 4 illustrates some typical results. Amplitudes of polar motion are of the order of 0.2 arcsec, and two distinct periodicities are seen, one at 12 months, the other at 14 months known as the Chandler wobble. Much longer period or secular changes may also occur.

The geophysical causes for the irregularities in rotation are varied (Figure 5), being any process that modifies the second order inertia tensor of the Earth or which exerts a torque on the crust and mantle. The interest in the study of the rotation is twofold. It lies in this diversity of excitation mechanisms involving meteorology, oceanography, solid Earth physics and magneto-hydrodynamics. Secondly, it lies in the search for observations of this rotational motion that goes far

Figure 1

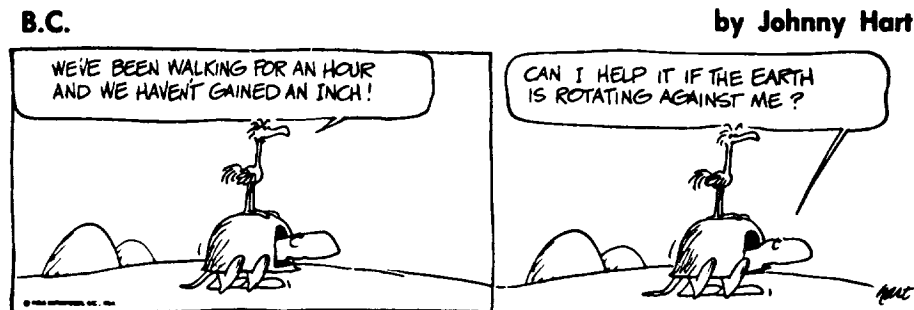

\*See Munk and MacDonald (1960). I have not been able to find the second calculation recorded here but I have it from several sources that Munk carried this one out. He did consider the consequences of an equatorial merry-go-round.

(by permission of Johnny Hart and Field Enterprises, Inc.).

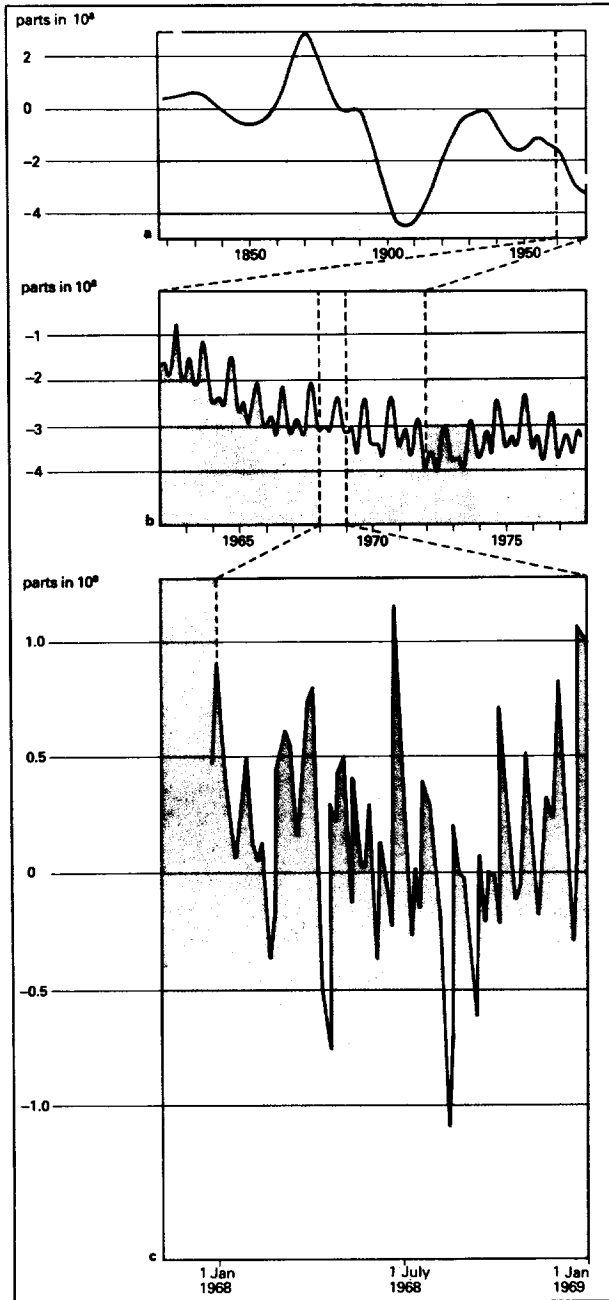

Figure 2. Proportional changes in length-of-day,  $m$ . (a) From 1820-1975. Only fluctuations that persist for about 10 years or longer are evident. (b) From 1962-1978. Seasonal variations are now clearly evident. (c) For 1968 after removal of the seasonal effects. Some of the high frequency fluctuations may represent noise in the astronomical measurements but some of the larger changes can be attributed to changes in atmospheric circulation.

beyond the telescope observations of the last one hundred or so years.

It would be nice to think that Walter was drawn to the study of the Earth's rotation by the idea of polar hula dancers, but it appears that the truth lies elsewhere. Victor Starr in 1948 had recognized that seasonal variations occurred in

the net zonal angular momentum of the atmosphere and that this must be accompanied by changes in the Earth's rotation. Starr thought that the net effect was imperceptible but Munk must have thought otherwise. With R.L. Miller he evaluated this imbalance and showed that it did, in fact, explain the seasonal changes in length-of-day previously, but precariously, observed by N. Stoyko and others (Munk and Miller, 1950). A new aspect of Walter's career was launched.

It often happens in studies of the Earth's rotation, as it must in most other areas of observational science, that astronomical data are revised, that the physical mechanisms or excitation functions are re-evaluated and that what initially agreed now disagrees. Obvious examples are the tidal friction question and the excitation of the Chandler wobble. It also happened with the seasonal changes in length-of-day and it took nearly 20 years to show definitively that Munk and Miller were correct (Lambeck and Cazenave, 1973). In Munk's own words "definitive papers are usually written when a subject is no longer interesting" (Munk, 1980). But, fortunately, definitive papers inevitably raise new questions and this has been the case here. Do, for example, the small discrepancies between the observed and computed rotational changes shed information on the anelasticity of the Earth or on oceanic contributions? Do the astronomical observations provide information on the atmospheric circulation? Separately from this, the interaction between the atmospheric circulation and the Earth's rotation is now known to encompass a very broad spectrum, and it has been suggested that the astronomical data could be introduced as constraints on global atmospheric circulation solutions (Lambeck and Cazenave, 1977; Hide, 1977).

Being an oceanographer at heart, it was obvious that Munk should also look at analogous interactions between the oceans and the rotation. With Miller and G. Groves he investigated the angular momentum exchange between ocean currents and the solid Earth; with R. Revelle he investigated the rotational consequences of an exchange of mass between the polar ice sheets and the oceans (Munk and Groves, 1952; Munk and Revelle, 1952a). Munk recognized immediately that the study of the Earth's rotation goes beyond explaining the astronomical data and that other geophysical concepts could be explored using the data as constraints (Munk and Revelle, 1952b). Thus he attempted to draw conclusions about the exchange of mass between the polar ice sheets and the oceans from the wobble observations, speculated about the relation between the geomagnetic field and the length-of-day changes, the pole tide and excitation of the Chandler wobble and tidal friction.

Munk was, and I think still is, fascinated by the problem of tidal dissipation and lunar orbit evolution (Munk, 1982). Here he had to draw on a range of subjects that are rarely encountered in geophysics: the rigours of celestial mechanics; the ambiguity of astronomical observations whether taken by telescopes or deciphered from the histories and legends of past civilizations; the speculations of past ocean geometries and thermal evolution of the Earth; the search in the geological record for Gerstenkorn's close encounter. Only the palaeontological evidence for past tidal frequencies escaped Munk's search for a way to constrain the problem, it being

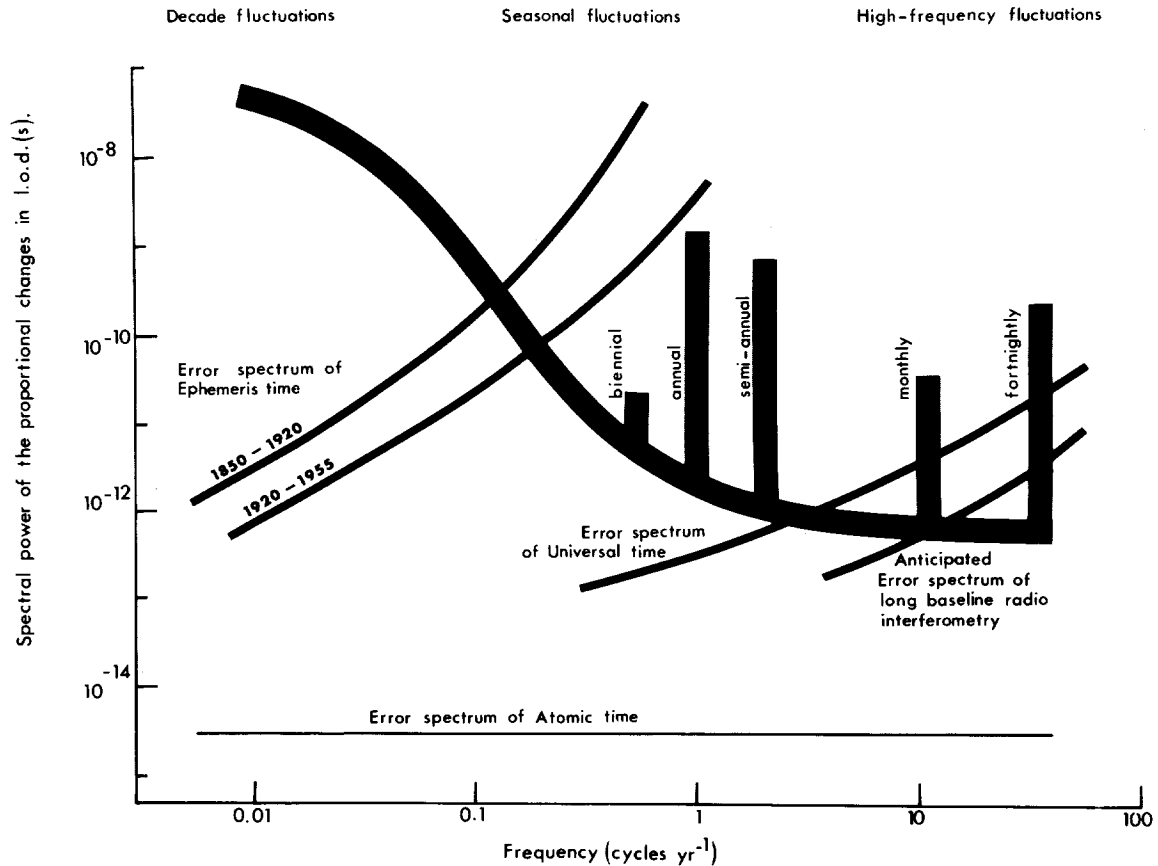

Figure 3. Schematic spectrum of length-of-day changes and error spectra.

some three years after the publication of *The Rotation of the Earth* that Wells (1963), and later Scrutton (1965) presented evidence for more days in the Devonian year than there now are. In hindsight, clues to the existence of these palaeontological chronometers are found in Wells' work nearly two decades earlier, when he suggested that lesser annulations between annual growth patterns in corals may reflect monthly fluctuations. Fossil records would then provide a measure of the number of (synodic) months in the year, a quantity that is proportional to the difference in the apparent mean orbital motions of the Moon and Sun about the Earth. T.F. Goreau's demonstration in 1959 that the much finer growth structure of coral epitheca, already much remarked upon, were controlled by diurnal factors should also have been a pointer. But not until later did Wells count the number of fine growth rings between seasonal growth rings to estimate the number of days in the Devonian year. Scrutton counted the number of ridges between the "monthly" growth rings and obtained an estimate of the number of days in the synodic month. These observations have added even more scope to speculating on this fascinating question. If these fossil astronomers were only aware of the controversy they were to cause later they would surely have opted for different lifestyles.

By 1960 Munk had teamed up with Gordon MacDonald and written the book that redirected research in the rotation

of the Earth for the next two decades (Munk and MacDonald, 1960). I am not sure that the full importance of this work was immediately recognized if the few reviews that I have been able to find are any guide. Nevertheless some astute observations were made. Jack Jacobs, for example, wrote "... it is a timely reminder to the complacent to find that many of the problems considered as solved in the 1920's are now wide open." Keith Runcorn grumbled about their circumspect treatment of palaeomagnetism. He was later to grumble about my treatment of another aspect of the Earth's rotation.

Perhaps, the book was not so important after all if we consider the dictum attributed to Bob Stewart that "You can measure the status of a scientist by the time he held up further development of the field." After all, the book began to influence research within a few years. Alternatively, solid-earth physicists are different from oceanographers.

Having written the book, Munk promptly dropped the subject, apparently returning to it only once to give the Harold Jeffreys lecture at the Royal Astronomical Society in 1968. He had "entered a field with little or no modern literature, to leave it some ten years later in a state of lively participation and an increasing flux of publications." That Munk had this influence must be due to several factors, other than having such excellent coauthors. Foremost must be that Munk entered the field unhampered by detailed knowledge of the

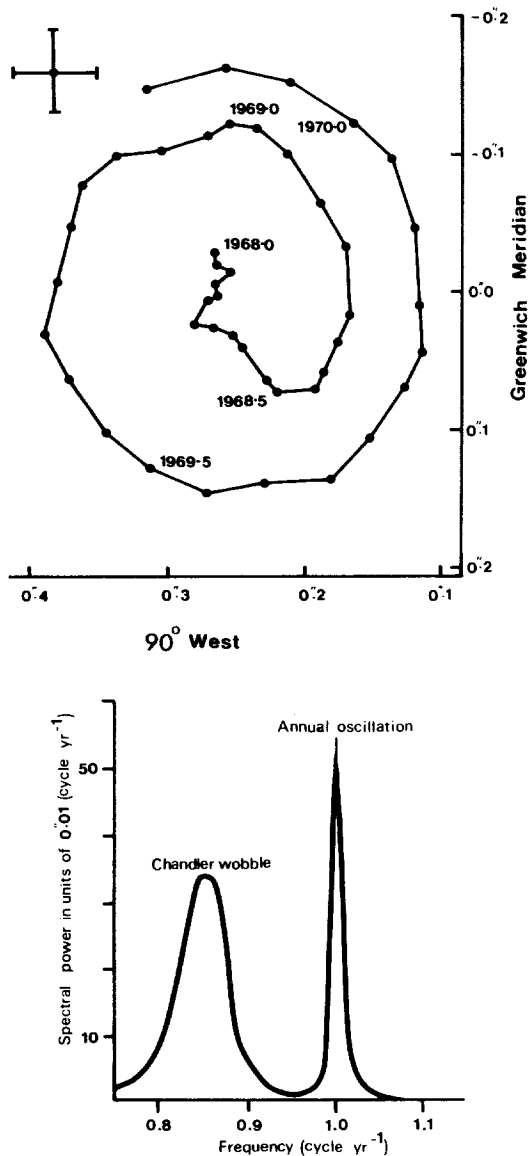

Figure 4. (Top) The pole path from 1968 to early 1970 as determined by the Bureau International de l'Heure at intervals of 0.05 years. Error estimates are indicated at the top left-hand side. (Bottom) Schematic spectrum of the polar motion. The two peaks are at 14 and 12 months. Some signal may occur at very low frequencies.

astronomical observations. I suspect that the cry "... beware of the screw correction!" tells us more about Walter's character than it does about his knowledge of the details of the astronomical measuring process. Where others feared to draw conclusions because they were only too aware of all the weaknesses of the astronomical data, Munk and coauthors did not hesitate. They were invariably right. Munk also had the inspiration to treat polar motion or wobble together with the length-of-day changes. Because different observing techniques and instruments were used to observe these two aspects of the Earth's rotation, astronomers generally treated length-of-day and polar motion separately. Munk recognized that the geophysics was the same and that more geophysical

information could be extracted by treating wobble and length-of-day together. Another important factor was that, following Sir Harold Jeffreys, Munk took the subject properly into the realm of geophysics, out of the hands of astronomers who tend to discuss geological problems with the certainty normally reserved for celestial mechanics. In this respect he has not been entirely successful. At a meeting a year or two back, an astronomer discussed the effect of continental drift on rotation in terms of "If we remove Australia, then ...".

My own interest in the subject post-dates Munk and MacDonald's book by nearly a decade. I had purchased the book much earlier, at a time when I could ill-afford it, but it stayed largely unread while I worked at the Smithsonian Astrophysical Observatory on graver problems: on the determination of the Earth's gravity field from satellite orbit analyses. It was nevertheless clear to me, even then, that the conventional astronomical methods were reaching their limits of accuracy and that they would soon be inadequate if the research on satellite orbit analyses and gravity field determinations continued to progress rapidly. Also, the astronomical observations would not provide convincing tests of the then-revived hypothesis of earthquake excitation of the Chandler Wobble. (Munk and MacDonald had dismissed this possibility but the full extent of the earthquake displacement fields was not recognized until the work of M.A. Chinnery and F. Press in 1965.) My first attempt at an alternative approach for measuring Earth rotation was to use Baker-Nunn camera observations of artificial satellites recorded simultaneously at several sites. Such observations determine the orientation in space of the vectors joining the tracking stations, vectors that should change with time due to, *inter alia*, polar motion. The data were simply not good enough.

Not because of this failure, I moved to France in 1970 where I attempted to do the same thing again — this time by computing changes in inclination of orbits of satellites tracked by lasers. Again I failed (Lambeck, 1971). The laser-range data were just too inadequate at this early stage. Others had more success: Anderle (1973) demonstrating what could be done with the Doppler observations of the navigation satellite network where the distribution of the data was much superior to that available from other tracking systems. Instead of pursuing this further I must have realized that interpretation of existing data was surely more productive. So, armed with Munk and MacDonald, I started again. On reading this book carefully for the first time I was immediately struck by the wealth of unresolved problems. Instead of summing up the subject, it seemed to me that many more problems were raised than solved. It proved to be a gold mine of ideas for me, as it must have for so many others. Furthermore, many geophysical observations now existed that could be used to test some of their ideas.

My first attempt was to evaluate the angular momentum of the atmosphere because I had become aware that R.E. Newell was preparing a very complete set of zonal wind data for the years 1958-1963. This led to the definitive explanation of the seasonal terms in length-of-day and also explained a rather erratic quasi-biennial term previously noted by Iijima and Okazaki (1966). Furthermore, it quantitatively confirmed

that the meteorological excitation spectrum was broad indeed, and that much of the high frequency power in the rotation spectrum was really meteorological noise (Lambeck and Cazenave, 1974). Thus I worried that it would be extremely difficult to extract other geophysical information from these data unless they could be corrected for atmospheric effects. Recent work suggests that this may now be possible (Hide *et al.*, 1980; Rosen and Salstein, 1983; Lambeck and Hopgood, 1982).

In searching through the meteorological literature for further information, I became aware of the longer term fluctuations in climate that seemed to resemble the decade-scale variations in length-of-day. Munk and MacDonald correctly ruled out any significant meteorological and oceanographic excitation of the length-of-day at these time scales but the observations were, nevertheless, intriguing. Periods of surface warming and increasing strength of the zonal circulation coincided with times of an accelerating Earth (e.g. 1850-1870 and 1900-1940) while periods of general surface cooling and breakdown of the zonal circulation coincided with times of deceleration (e.g. 1870-1900, 1950-present) (Lambeck and Cazenave, 1976). I have never been quite sure what to make of this, particularly as the migration of whales in the Pacific Ocean purportedly follows a similar pattern. Others have hesitated less. It is a subject I always intend to get back to, but somehow never do.

In the meantime I had regressed back to an old habit of looking at satellite tracking data. This time we looked for orbital perturbations of tidal origin. I was rather disturbed by the neglect of ocean tides in the earlier works of Y. Kozai and R.R. Newton and even more puzzled by the strange results for the Love number  $k_2$  and phase lag that were then creeping into the literature. W.M. Kaula had already developed a comprehensive tidal perturbation theory but I failed to see how this could be conveniently applied to ocean tides where the response is frequency dependent. Hence we developed a specific theory for the perturbations in artificial satellite orbits caused by ocean tides and we were able to demonstrate that many of the disparate Love numbers and phase lags were, in fact, due to the neglect of ocean tides (Lambeck *et al.*, 1974). The numbers we found did lead us back to the by now well thumbed and annotated copy of the *Rotation of the Earth*. What to do with these funny looking results and what ocean-tide information did our parameters contain? (This is beginning to sound like Wilkie Collins' Betteredge's frequent consultation of Robinson Crusoe in times of need.) Again I found my answer there: the numbers represented the integral of the work done by the Moon and Sun on the ocean surface. What we had come up with was a new measure of the dissipation of tidal energy. Only a short step was now required to replace, in the equations of motion, the artificial satellite by the Moon and to obtain a measure for the lunar acceleration in terms of parameters deduced from satellite orbit analyses (Lambeck, 1975, 1977). Now, by comparing astronomical estimates of the lunar acceleration with the satellite parameters, it is possible, at least in principle, to separate dissipation of tidal energy in the Earth and Moon.

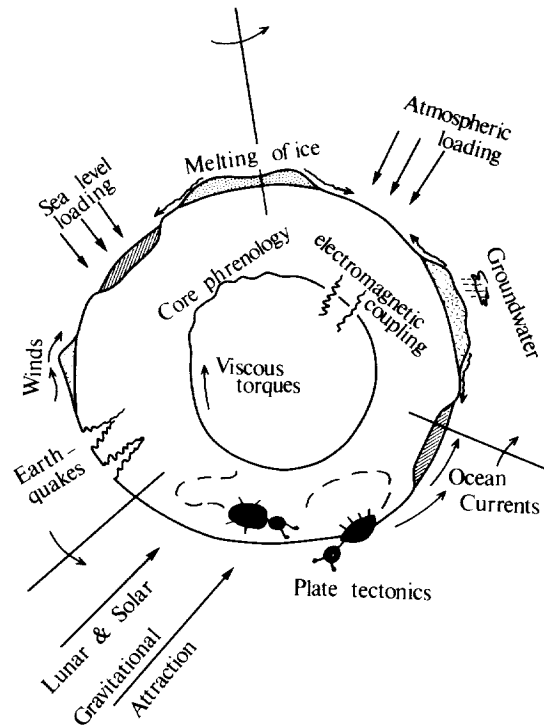

Figure 5. Summary of geophysical factors perturbing the Earth from uniform rotation. Geomagnetists will recognize R. Hide's contribution to geophysics. The beetles are due to T. Gold (from *Nature* 286, 104, 1980).

By the mid 1970's I started writing a book on the Earth's rotation, since the subject had now evolved to a point similar to that at which Munk must have found it nearly twenty years earlier. A plateau had been reached and the next significant quantum jump in information would only come after new methods of measuring the Earth's rotation had produced long series of improved data sets. I have previously outlined some of the important developments that have occurred since the publication of Munk and MacDonald's book (Lambeck, 1980) but in the present spirit a more personal account is appropriate. In discussing the geophysics of the Earth's rotation, it is so easy to overlook the efforts made by those who produce the data upon which the interpretations rest. It is even easier to be critical after their work is done. B. Guinot's work at the Bureau Internationale de l'Heure of revising the post-1955 data, of maintaining uniformity throughout and of continually improving the quality of the astronomical data, is paramount. Likewise, L.V. Morrison has rendered an invaluable service in revising the older telescope observations that go back to the start of the nineteenth century. R.R. Newton and F.R. Stephenson's work on interpreting the old eclipse records has provided a much better understanding of the historical accelerations. Compare the eclipses selected by Munk and MacDonald as reliable with the conclusions reached by Stephenson (1972).

Much of the revised geophysical discussion rests on these foundations. Congruent with Munk and MacDonald's book was M.G. Rochester's (1960) work on electromagnetic core-mantle coupling, pursued further by him for the next decade

(see Rochester, 1973). R. Hide's work on core-mantle coupling has also contributed greatly (Hide, 1969, 1977). Mechanisms by which core motions are coupled to the mantle and vice-versa are now much better understood than in Munk's time. It also remains inescapable that this coupling is largely responsible for the decade fluctuations in length-of-day. What remains controversial is the choice of mechanism: is it by electro-magnetic coupling or is it by topographic coupling, Hide's core precession? Recent papers by Le Mouél and coauthors and the Royal Society Discussion Meeting show that this subject is still much alive (Le Mouél *et al.*, 1981) but the definitive paper is not even in sight.

The work by W.M. Kaula, G.J.F. MacDonald, P. Goldreich and H. Gerstenkorn in the period 1964-1969 led to a much improved understanding of the celestial mechanics of the Earth-Moon system although the time scale problem remained poorly constrained. At the time of Munk and MacDonald's work there was still much controversy about where the bulk of tidal energy was dissipated: in the oceans or in the solid Earth. This, I would like to think, is now resolved, with some 90-95% or more of the energy being dissipated in the oceans (Lambeck, 1977, 1980). This conclusion is based mainly on the important work done by C. Pekeris, M. Hendershott and W. Zahel in modelling the global ocean tide. Actually, how the energy is dissipated remains more obscure and debatable. With continental-drifters and pole-twisters ruling present-day geophysics, it is only a short step to argue that past ocean configurations were sufficiently different to invalidate any simple extrapolation of the lunar motion backwards into time. Several attempts have been made to model dissipation in bygone oceans (e.g. Brosche and Sundermann, 1977; Webb, 1982; Hansen, 1982) but simpler arguments can also be marshalled to diminish the importance of this evolutionary time-scale problem (Lambeck, 1982). Those who do not like the Gerstenkorn event can rest in peace. The palaeontological evidence, in the form of growth rhythms of coral and bivalve fossils, has helped somewhat, but the initial excitement, stirred by Wells and Scrutton and fanned by Runcorn, has been damped by the realization that the problem is considerably more complex than originally appreciated. Perhaps the best evidence remains that of Wells and Scrutton for coral fossils. Growth habits of modern bivalves have been investigated, notably by Clark (1974) and Evans (1972), but the pattern is complex, being stimulated by both the day-night alternations and the tidal cycle. Pannella (1972) assumed that the number of ridges between lesser annulations was a measure of the number of days in the synodic month while Berry and Barker (1968) assumed they reflected tidal influence! No serious results have been published since about 1975. The stromatolite evidence is even more circumspect. Certainly the living fossils in Shark Bay do not possess good chronometric attributes. Much of the information remains circumstantial and the hypothesis rests in large part on the observation that the observed periodicities in living samples correspond to what one expects. Conclusions about the actual accelerations during the geological past remain on an uncertain footing indeed.

The already mentioned work of Chinnery and Press laid the groundwork for the revival of the earthquake excitation

of the Chandler-wobble by L. Mansinha and D.E. Smylie. The subsequent discussions between these authors and F.A. Dahlen, R.A. Haubrich and others are highlights of the last two decades. Work on revising the moment-magnitude scale by K. Aki, M.A. Chinnery and H. Kanamori led to a revival of the hypothesis by R.J. O'Connell and A.M. Dziewonski in 1976, but today's conclusions are still unsatisfactory. The nature of the mechanism maintaining the wobble against damping remains elusive. Excitation by the changes in the inertia tensor caused by large earthquakes alone appears inadequate. Aseismic deformation may be more important but cannot yet be fully evaluated. Atmospheric excitation, by irregular fluctuations in the atmospheric mass distribution, also appears to be insufficient. Probably a combination of factors is responsible.

Studies of rotation and tidal deformation of the Earth have become more realistic since 1960 and while many of the conclusions reached by H. Jeffreys and M.S. Molodensky are essentially correct, I, for one, understand the problem better, thanks to papers by W.E. Farrell, W.R. Peltier, M.L. Smith and T. Sasao and colleagues. Wahr (1980) has most recently discussed these questions in what may be "definitive" papers. The most complete discussion of the tidal deformations of a planet with oceans and a fluid core is by Merriam (1980). Other highlights of the post-Munk era in the history of the Earth's rotation include C. Wunsch's work on the pole tide, and R.J. O'Connell's work on pleistocene deglaciation effects on rotation, a subject also drawing much attention now (Nakiboglu and Lambeck, 1980; Sabadini and Peltier, 1981).

Perhaps it is appropriate here to go back and speculate on that subject I try to avoid: the qualitative relations seen on the decade scale between the changes in length-of-day (l.o.d.), climate, geomagnetic field parameters, and possibly earthquake and volcanic activity. The climate-l.o.d. similarities for the period 1840 to the present, can be characterized as follows: periods of increasing zonal wind activity and of increasing global surface warming (Type 1 circulation) appear to coincide with an accelerating Earth; periods of cooling and decreasing zonal wind activity (Type 2 circulation) coincide with a decelerating Earth (Figure 6a). The years 1900-1930 and 1840-1870 are characteristic of the former while the years 1870-1900 and 1950-present are characteristic of the latter phase. The evidence for this is sparse and diverse but we did note that there is a general lag of some 10 years of the climatic indicators behind the l.o.d. This is seen, for example, in the surface temperature (Figure 6b). This does not make l.o.d. a good predictor of climate change. First of all, the relationship is tenuous at best. Secondly, the change in length-of-day,  $\Delta$ (l.o.d.), is a global response. Thirdly, the  $\Delta$ (l.o.d.) is a response to many geophysical factors with a variety of time scales. For example, is the upturn in  $m$  seen towards the end of the seventies a start of a major change, as occurred near 1900-1905? Or is it merely a change on a 3-5 year time scale that has frequently been seen since atomic time was first introduced? The combined meteorological and oceanographic excitation function appears to be an order of magnitude too small to explain the decade changes in l.o.d. approaching 1 part in  $10^8$  from 1870 to 1900. This leaves open two alternative interpretations: (a) the l.o.d. and



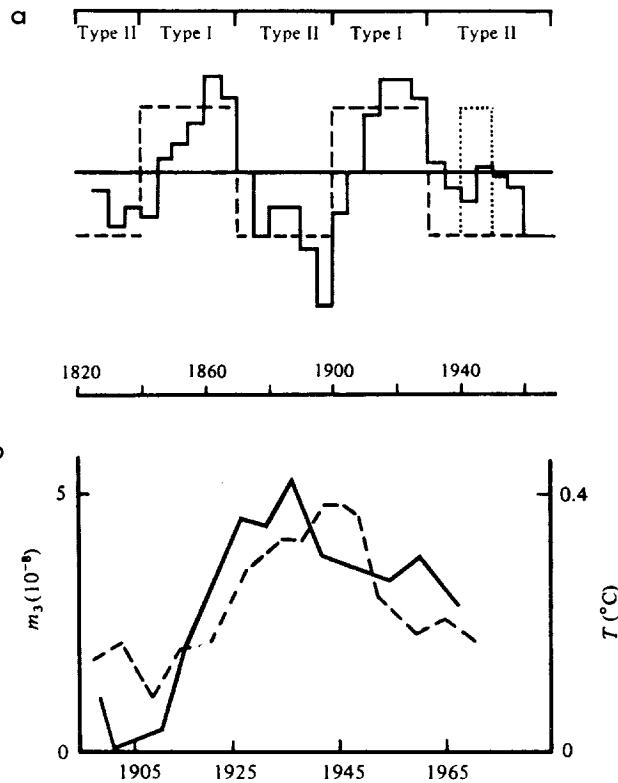

Figure 6. (a) Schematic representation of the circulation pattern (broken line) in terms of the Type I and Type II circulation defined in the text. The dotted line indicates a secondary period of Type I circulation. The astronomically observed  $m$  (running mean values over 15 yr) are indicated by the solid line. The Type I circulation corresponds to positive  $m$  and Type II circulation corresponds to negative  $m$  (from 23). (b) Variations in  $m$  (solid line) and in global surface temperature  $T$  (broken line) from 1900-1970 (from 23).

climatic changes are both the consequence of a third phenomenon, (b) the fluctuations in l.o.d. cause the observed variations in the circulation. The latter possibility has already been suggested (e.g. Maximov and Sleptsov-Shevlevich, 1973) but the mechanism remains obscure and, in view of the smallness of the energy involved, improbable.

The first possibility is more attractive, particularly if we restrict ourselves to arm-waving. One scenario is that earthquake activity and associated aseismic deformation cause changes in the inertia tensor and in the l.o.d. In some regions volcanic activity appears to follow upon periods of major seismic events — we are talking about average conditions over a few years — and the concomitant dust injected into the atmosphere then explains the observed similarity between l.o.d. and the climatic factors. Observations in support of this are suggestions that long-term trends in both seismic and volcanic activity follow the l.o.d. and that the observed lag between seismic and volcanic activity in certain regions is of the order of 5-10 years (Stoyko and Stoyko, 1969; Press and Briggs, 1975; Anderson, 1974). However, the energy released by earthquakes and lithospheric motions is inadequate unless the aseismic component is more significant than estimated so far.

This particular scenario does not introduce the geomagnetic field into the argument. Evidence for correlation between this field and l.o.d. remains circumspect but some observations, such as the vertical component of the magnetic field, exhibit regional changes on the decade time scale that follow the length-of-day. In particular, changes noted in Europe (Golovkov and Kolomitzeva, 1971) (Figure 7a) and in South Africa (Bullard, 1948; Roberts, 1972) appear to follow similar patterns, indicating that there may have been a global modification in the magnetic field towards 1890-1900. This is also suggested by variations in the dipole term  $g_1^0$ , for the years 1880 to 1970 (Figure 7b) (see also Yukutake, 1973). The scenario is now the following. Electromagnetic torques on the core-mantle boundary change the Earth's rotation and manifestations of these torques are seen at the Earth's surface; and there is a suggestion of this lag in the data. Interactions between the changing planetary field and the atmosphere would somehow have to produce the climatic

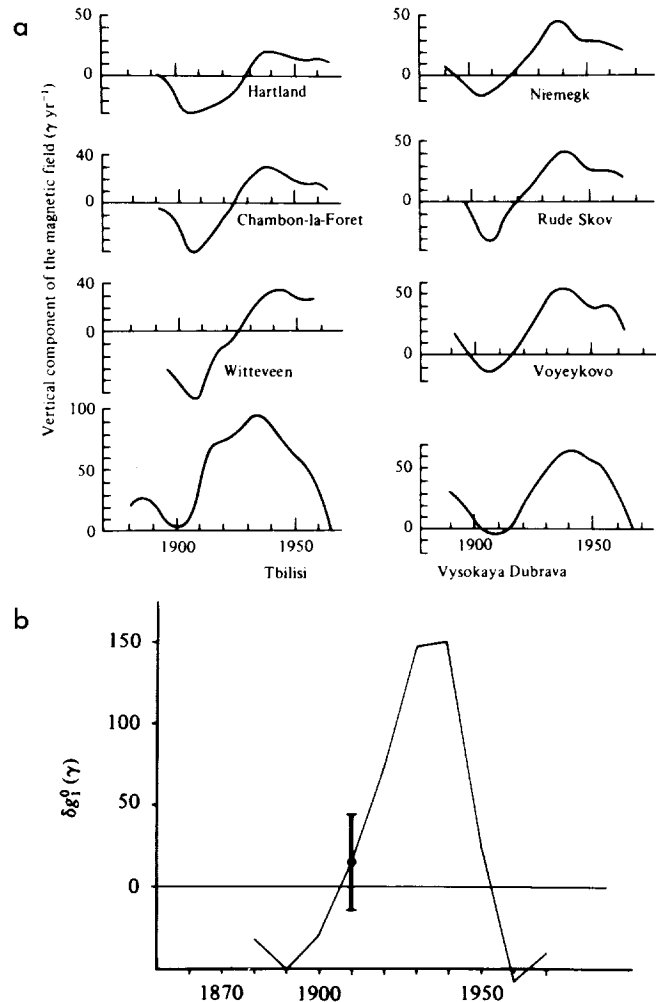

Figure 7. (a) Secular variations in the vertical component of the magnetic field at eight different stations in Europe (after V.P. Golovkov and G.I. Kolomitzeva, see also 28). (b) Variations in dipole term  $g_1^0$  after removal of a secular trend. Error bar is representative of 10 year averages (from 28).

changes. This scenario leaves out the earthquake-volcanic activity link. Some will argue that the changing stress-state in the mantle is the explanation, but again the energetics of this appear to be wholly inadequate.

Lurking behind all of this, and at least one reason for me to keep out of this field, is the role of fluctuations in solar activity. What quicker way to be a disreputable scientist but to introduce sunspots into the correlations! Yet the Earth's rotation has not been immune from correlation with sunspots and solar indices. I have even suggested something like this myself albeit in a slightly different context (Lambeck and Hoggood, 1982). At the moment solar influences on climate appear to be vaguely respectable but the changes in atmospheric circulation are inadequate to explain the length-of-day changes. This leads to the suggestion of a direct interaction between the solar wind and the geomagnetic field but again the magnitude of this is entirely insignificant.

Perhaps the missing link in all of this is the ocean. So far, the results for this do not appear to be very encouraging. Also, I am not foolish enough to address myself to an oceanographic problem here at this meeting, which is predominantly of oceanographers. Instead I can only hope that Walter, in his retirement and with nothing (more!) to lose, will pick up the various loose ends and bring some order into this chaos. I wish you, Walter, a busy "retirement."\*

#### References

- Anderle, R.J. 1973. Determination of polar motion from satellite observations. *Geophys. Surv.*, **1**, 147.
- Anderson, D.L. 1974. Earthquakes and the rotation of the Earth. *Science*, **182**, 49.
- Berry, W.B.N. and R.M. Barker. 1968. Fossil bivalve shells indicate longer month and year in Cretaceous than present. *Nature*, **217**, 938.
- Brosche, P. and J. Sundermann. 1977. Tides around Pan-gaea. *Naturwissenschaften*, **64**, 89.
- Bullard, E.C. 1948. The secular change in the Earth's magnetic field. *Mon. Not. R. Astr. Soc., Geophys. Suppl.* **5**, 248.
- Clark, G.R. 1974. Growth lines in invertebrate skeletons. *Ann. Rev. Earth Planet. Sci.*, **2**, 77.
- Evans, J.W. 1972. Tidal increments in the cockle *Clinocardium nuttalli*. *Science*, **176**, 416.
- Golovkov, V.P. and G.I. Kolomiitzeva. 1971. Morphology of 60-year geomagnetic field variations in Europe. *Geomagn. Aeron.*, **11**, 674.
- Hansen, K. 1982. Secular effects of oceanic tidal dissipation on the Moon's orbit and the Earth's rotation. *Revs. Geophys. Space Phys.*, **20**, 457.
- Hide, R. 1969. Interaction between the Earth's liquid core and solid mantle. *Nature*, **222**, 1055.
- Hide, R. 1977. Towards a theory of irregular variations in the length of day and core-mantle coupling. *Phil. Trans. R. Soc. Lond.*, **A 284**, 547.
- Hide, R., N.T. Birch, L.V. Morrison, D.J. Shear and A.A. White. 1980. Atmospheric angular momentum fluctuations and changes in the length-of-day. *Nature*, **286**, 114.
- Iijima, S. and S. Okazaki. 1966. On the biennial component in the rate of rotation of the Earth. *J. Geod. Soc. Jap.*, **12**, 91.
- Lambeck, K. 1971. Determination of the Earth's pole of rotation from laser range observations to satellites. *Bull. Geod.*, **101**, 263.
- Lambeck, K. 1975. Effects of tidal dissipation in the oceans on the Moon's orbit and the Earth's rotation. *J. Geophys. Res.*, **80**, 2917.
- Lambeck, K. 1977. Tidal dissipation in the oceans. *Phil. Trans. R. Soc. Lond.*, **A 287**, 545.
- Lambeck, K. 1980. *The Earth's Variable Rotation*. Cambridge University Press.
- Lambeck, K. 1982. Where has that Moon been? *Nature*, **298**, 704.
- Lambeck, K. and A. Cazenave. 1973. The Earth's rotation and atmospheric circulation. I. Seasonal variations. *Geophys. J.*, **32**, 79.
- Lambeck, K. and A. Cazenave. 1974. The Earth's rotation and atmospheric circulation, II. The continuum. *Geophys. J.*, **38**, 49.
- Lambeck, K. and A. Cazenave. 1976. Long term variations in length of day and climatic change. *Geophys. J.*, **46**, 585.
- Lambeck, K. and A. Cazenave. 1977. The Earth's variable rate of rotation. *Phil. Trans. R. Soc. Lond.*, **A 284**, 495.
- Lambeck, K., A. Cazenave and G. Balmino. 1974. Solid Earth and oceanic tide estimated from satellite orbit analysis. *Revs. Geophys. Space Phys.*, **12**, 421.
- Lambeck, K. and P. Hoggood. 1982. The Earth's rotation and atmospheric circulation. *Geophys. J. R. Astr. Soc.*, **71**, 581.
- Le Mouel, J.-L., T. Madden, J. Ducruix and V. Courtillot. 1981. Decade fluctuations in geomagnetic westward drift and Earth rotation. *Nature*, **290**, 763.
- Maximov, I.V. and B.A. Slepsov-Shevlevich. 1973. Variation of the Earth's velocity of rotation and the pressure field of the northern hemisphere. *Dokl. Akad. Nauk. SSSR*, **210**, 79.
- Merriam, J.B. 1980. Zonal tides and changes in the length of day. *Geophys. J.*, **62**, 551.

\*Editors' Note. Wishful thinking, perhaps. Walter has no intention of retiring.

- Munk, W.H. 1980. Affairs of the sea. *Ann. Revs. Earth Planet. Sci.*, **8**, 1.
- Munk, W.H. 1982. Review. *Geophys. J.*, **69**, 831.
- Munk, W.H. and G. Groves. 1952. The effect of winds and ocean currents on the annual variation in latitude. *J. Meteor.*, **9**, 385.
- Munk, W.H. and G.J.F. MacDonald. 1960. *The Rotation of the Earth*. Cambridge University Press.
- Munk, W.H. and R.L. Miller. 1950. Variation in the Earth's angular velocity resulting from fluctuations in atmospheric and oceanic circulation. *Tellus*, **2**, 93.
- Munk, W.H. and R. Revelle. 1952a. Sea level and the rotation of the Earth. *Am. J. Sci.*, **250**, 829.
- Munk, W.H. and R. Revelle. 1952b. On the geophysical irregularities in the rotation of the Earth. *Mon. Not. R. Astr. Soc., Geophys. Suppl.* **6**, 331.
- Nakiboglu, S.M. and K. Lambeck. 1980. Deglaciation effects on the rotation of the Earth. *Geophys. J.*, **62**, 49.
- Pannella, G. 1972. Paleontological evidence on the Earth's rotational history since Early Precambrian. *Astrophys. Space Sci.*, **16**, 212.
- Press, F. and P. Briggs. 1975. Earthquakes, Chandler wobble, rotation and geomagnetic changes: a pattern recognition approach. *Nature*, **256**, 270.
- Roberts, P.H. 1972. Electromagnetic core-mantle coupling. *J. Geomagn. Geoelectr.*, **24**, 231.
- Rochester, M.G. 1960. Geomagnetic westward draft and irregularities in the Earth's rotation. *Phil. Trans. R. Soc. Lond.*, A **252**, 531.
- Rochester, M.G. 1973. The Earth's rotation. *Trans. Am. Geophys. Un.*, **54**, 769.
- Rosen, R.D. and D.A. Salstein. 1983. Variations in atmospheric angular momentum on global and regional scales and the length of day. (Submitted to *J. Geophys. Res.*)
- Sabadini, R. and W.R. Peltier. 1981. Pleistocene deglaciation and the Earth's rotation. *Geophys. J.*, **66**, 553.
- Scrutton, C.T. 1965. Periodicity in Devonian coral growth. *Palaeontology*, **7**, 552.
- Stephenson, F.R. 1972. Some Geophysical, Astrophysical and Chronological Deductions from Early Astronomical Records. Thesis, University of Newcastle.
- Stoyko, A. and N. Stoyko. 1969. Rotation de la terre, phénomènes géophysiques et activité du soleil. *Bull. Acad. R. Belg., Ser. 5* **55**, 279.
- Wahr, J.M. 1980. The body tides on an elliptical, rotating, elastic and oceanless Earth. *Geophys. J.*, **64**, 677.
- Webb, D.J. 1982. The effect of polar wander on the tides of a hemispherical ocean. *Geophys. J.*, **68**, 689.
- Wells, J.W. 1963. Coral growth and geochronometry. *Nature*, **197**, 949.
- Yukutake, T. 1973. Fluctuations in the Earth's rate of rotation related to changes in the geomagnetic dipole field. *J. Geomagn. Geoelectr.*, **25**, 195.

# WALTER, ARISTOTLE AND THE TIDES OF THE EURIPUS

Adrian Gill

*University of Cambridge  
Cambridge, England*

It is a great pleasure to share in this happy occasion in honor of Walter, and to hear how Walter helped so many people on their careers with wonderful problems. I feel very happy for them because my experience was exactly the opposite! I first came to IGPP in 1965 and Walter asked me to explain the large super-adiabatic temperature gradients at the bottom of the ocean. I couldn't, but provided Walter with a few formulae so he said, "Never mind, come back next year. I'll have some good measurements then." So I came in 1966 and he took me on the *Ellen B. Scripps* to show off his wonderful capsules which had been recording at the bottom of the ocean. But the capsule came up throttled by its own umbilicus, so Walter said, "Never mind, come back next year. I'll have some good measurements then." So I came again in 1967. It seems that Judy had solved his problems with something called the "flower-pot technique", and there weren't any large super-adiabatic gradients after all. However, I'd got hooked on the idea of visiting Scripps and have been trying to give up the habit ever since.

But what about Aristotle? I became interested in Aristotle through trying to spice up my book with a few stories. What better story could there be than the one about Aristotle committing suicide because he couldn't solve an oceanographic problem? The Master of my college in Cambridge happened to be a distinguished classicist and he gave me some good references which I'll pass on to you now. The first is from Procopius' *History of the Wars* VIII,vi.

Indeed, it was this question which led Aristotle of Stagira, a man prominent among all others as a philosopher, to go to Chalcis on Euboea, where he observed the strait which they call Euripus in an effort to discover the physical reason why sometimes the current flows from the west, but at other times from the east; whenever, for example, the current is running from the east and the mariners have begun to sail their boats from that direction following the inflow, if then the current turns upon itself, a thing which is wont to happen there many a time, it immediately turns these boats back in the direction from which they have started, even though no wind has blown upon them in the least; all this the

Stagirite observed and pondered a long time, until he worried himself to death with anxious thought and so reached the term of his life.

Another quote is from Justin Martyr. "Aristotle departed this life because he was overwhelmed with the infamy and disgrace of being unable to discover even the nature of the Euripus in Chalcis." Perhaps the most operative version of the story comes from Elias the Cretan: "When he failed to understand [the Euripus currents], he threw himself and was buried in that part of the sea, saying: 'Since Aristotle comprehends nothing of the Euripus, the Euripus has Aristotle.'"

When I was last in Scripps and talked to Walter about the Euripus problem, he handed me a copy of Munk and Miles and said, "Let's go there and sort it out ourselves." So, armed with some books from the Scripps Library, we did! In fact, one reason for coming today is to return the books to save Walter from the wrath of the Librarian.

For the printed version of the talk, it's been impossible to reproduce the beautiful series of slides showing the Chalcis area and the sequence showing the development of both northward and southward phases of the current. However, Figure 1 shows where the current accelerates as it enters the narrow bridge section (40 yards across) during the southward phase. Figure 2 shows a view looking towards the bridge across the south harbor. Look at this carefully and note the bush in the foreground, because that marks the spot associated with Walter's brilliant discovery.

But what about the science? I *could* tell you some fascinating stories about  $M_2:S_2$  ratios, about regular and irregular periods, and about mystery seiches. Instead I thought it would be more helpful to young scientists here to explain the scientific method and how great discoveries are made.

1. First and foremost, you have to have a first class back-up team (Figure 3).
2. Secondly, you have to think very hard about the problem (Figure 4).
3. Thirdly, you send your colleagues out on an information-gathering exercise (Figure 5).
4. Fourthly, when you've found the best source of information, you set up a meeting (Figure 6).

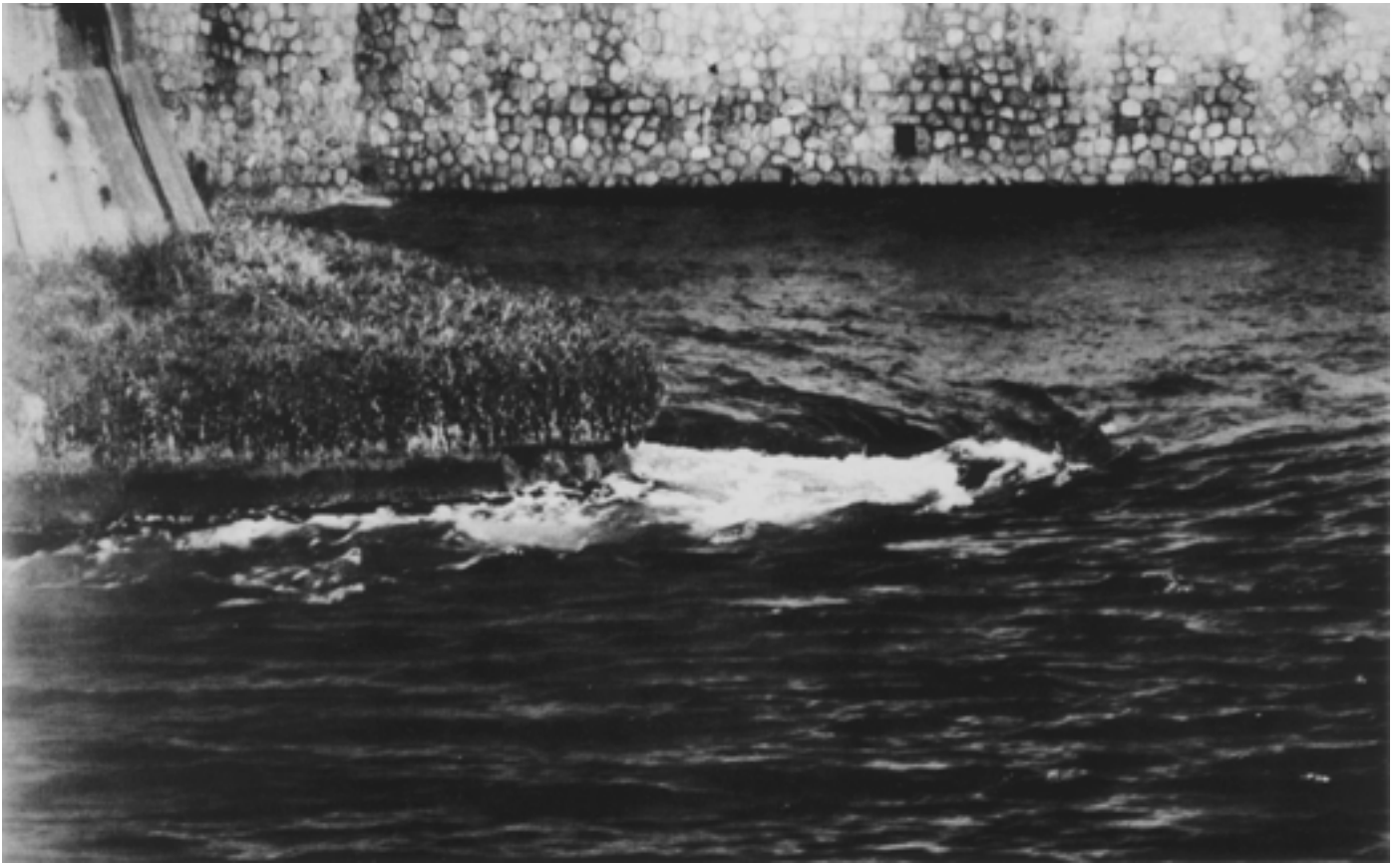

*Figure 1. Detail of NW buttress and southward current. 17 August 1981.*

*(All photographs by Helen Gill.)*



*Figure 2. Chalcis bridge from the south.*



Figure 3. Simon, Judy Munk, Jane. Chalcis, 17 August 1981.



Figure 4. Weighty thoughts. Chalcis, 17 August 1981.



Figure 5. Quizzing the locals. Chalcis, 17 August 1981.



Figure 6. Learning from Mr. Palmos, chief pilot. Chalcis, 17 August 1981.

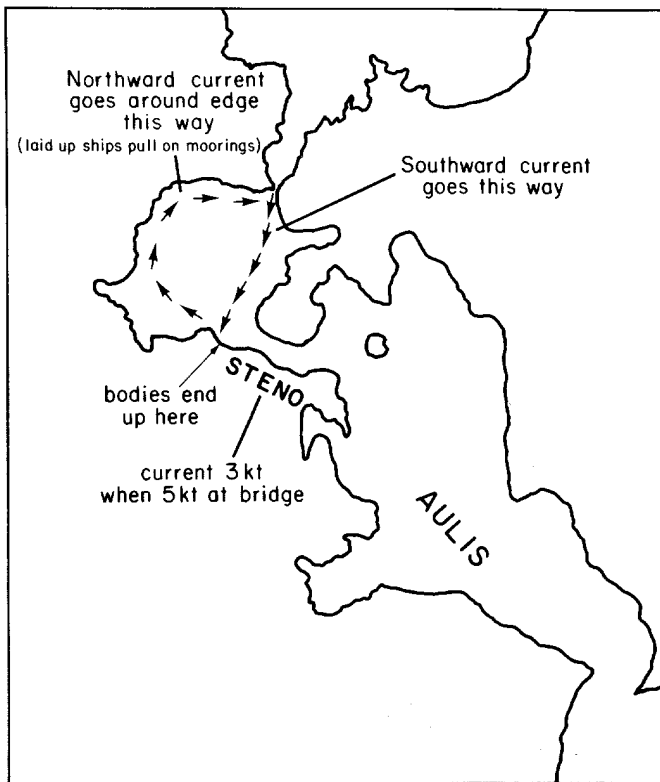

Figure 7. Currents in the South Harbour.

In this case, we spoke to Mr. Palmos, the chief pilot, who's been in the job for 30 years. And that's how Walter made his brilliant discovery. In a thousand years' time, HO161 (or whatever number it was) will be forgotten and acoustic tomography will be outmoded. But Walter will be remembered for this one brilliant discovery!

Figure 7 shows the information given to us by Mr. Palmos about currents in the South Harbour. When there is a northward flow, the current goes *around* the basin. When there is southward flow, the current forms a narrow jet *across* the basin. "You can tell that," said Mr. Palmos, "because the bodies end up on the south shore." And that is how Walter made his brilliant discovery because, after all these years, he had found the *last resting place of Aristotle*.

# STYLES OF SPECTRUM ANALYSIS

John W. Tukey\*

*Bell Laboratories and Princeton University  
Murray Hill, New Jersey 07974  
and Princeton, New Jersey 08544*

## Two Flavors

Walter Munk may well be the most effective practitioner of spectrum analysis the world has seen. So it is particularly appropriate that spectrum analysis is a topic today.

The name "spectrum analysis" includes the word "analysis" and connotes the word "data", at least to those who are gathered here today. It is as data analysts, then, that we should discuss it.

Like all forms of data analysis, spectrum analysis comes in two flavors (and an occasional mixture) — overt and covert. The overt flavor emphasizes flexibility and openness to the unexpected, and must thus avoid narrowly specified models, whose few constants would give a highly constrained view of some selected aspects of the data. As a consequence, the calculations to be made are not cast in concrete, and do differ from one data set to another — or even within a data set. We can never say that we know we have analyzed our data either "correctly" — if that word has a meaning — or in the "best way" — if there be such.

The covert flavor attempts the opposite — seeking, by dependence on a narrowly specified model, to have a "correct", "best-possible" analysis so that we need only look at the data through prechosen blinkers, penetrated only by a few pinholes — one corresponding to each constant that appears in the model. In the classical sense of the peekhole, the covert approach "spies on the data".

Both approaches have real and important places in the world — in science — and even in geophysics. Most discoveries, particularly of phenomena, however, are made by the overt approach.

## The Overt Approach: Some Examples

Munk and Snodgrass (1957) would never have seen the "southern swell off Guadalupe Island", if they had adopted a covert approach to their spectra of bottom-pressure measurements, fitting only a few — or even a moderate number of — constants, chosen on the basis of what was naively expected

— or even on the basis of all that had been thought of before they began.

If Munk and Snodgrass, and their successors, had all adopted a covert approach, how many decades — or centuries — would we have had to wait, before the combination of well and carefully planned measurement and the insight to look for a small moving peak would have been combined, so that the phenomenon would at last have been discovered?

Equally, Munk, Miller, Snodgrass, and Barber (1963) would have been very much less likely to find the second, more remote source of southern swell (12,500 miles away, rather than 10,000) if they had taken a covert approach to their more extensive data from a triplet of recorders.

There can be little question of the importance of the overt approach as a means of discovery.

## The Covert Approach

These examples do not deny the importance of the covert approach. They only confine it to its proper place.

But which covert approach? There are degrees of hiding from the world! Some are satisfied to apply the straitjacket of a few-constant model to the description of the spectrum that is being sought — and to be more ecumenical about the description of the probability structure. Others are not content with so small a degree of covertness. They insist on either "no probability structure" — an assumption hardly tolerable for any geophysical data I know — or on a similarly narrow set of assumptions about a specific probability structure. They might appropriately be termed "moles", both because of the espionage analogy, and because of the traditional failure of the animal to make any substantial use of vision — as might be inferred from the minuteness of its eyes.

Those whose covertness is a matter of shallow cover may seem to some to suffer from flexibility and lack of supportive restraint. Because they do not make narrow assumptions about their probability structure, they cannot avoid trial — and both error AND success — by actively seeking to learn what details of their method of analysis seem to lead to the best results. There is a situation for which we should have some sympathy — and much fellow feeling.

\*Editors' note: at the last moment, John Tukey was unable to attend the celebration. This talk was kindly given in his absence by John A. Rice, Department of Mathematics, University of California, San Diego.



### Detour on Data Analysis in General

If we are to place the varied shades of covertness in their proper light, we need to look at the last few decades of development of that part of formalized data analysis — often called "statistics" — and its handmaiden, "mathematical statistics".

Less than a century ago, Karl Pearson made "the method of moments" — the equating of observed averages (of simple functions of the data) to theoretical averages — a tool of wide application. While, from today's view, this tool was often clumsy, it was a considerable improvement on much that preceded it. In particular, it led to some emphasis on the diversity of distributions arising in practice. (These were mainly distributions of observed phenomena, rather than distributions of error, but there were exceptions, such as Student's 1927 paper on the errors of routine analysis.)

The next stage was tagged with the names of R.A. Fisher on the one hand, and those of Jerzy Neyman and Egon Pearson on the other. It was a stage of covertness about error, in which very detailed, but very simple, assumptions about "errors" were made freely and without question. Within these assumptions one could seek for straitjackets to prescribe:

- the computations to be made on the data, and
- the interpretations to be made from the numerical results.

Two sorts of straitjackets were sought:

- those which were matters of principle, not performance, and
- those which were matters of performance.

Fisher's emphasis on fiducial probability illustrates the former, while the "uniformly most powerful" objects of the other school illustrates the latter. This conflict was never really settled — we still do not know which approach provided the more useful techniques. (Lack of settlement was inevitable, since there was no way to measure "usefulness" that was acceptable to both sides.) This stage flourished for a few decades, and led to real and important diversification of what is still (but perhaps not for long) our kit of standard techniques.

Recognition of the narrowness of this approach — later called "over-utopian" by some — led to an era of conscious adoption of nonparametric techniques. The first conscious step in this direction may have been in Fisher's book on *The Design of Experiments* (1st edition 1935), though similar methods had been proposed in a scattering of papers for decades, often by social scientists. This approach did allow those who wished to do so to make nominal 5% be really 5%, in each of a very wide variety of situations. It did not allow us, however (so far as we have yet seen) to even define optimality in a sensible way. As a consequence we lost all but a trace of optimization. "Nonparametric" techniques — better tagged as "distribution-free" — received a lot of attention and contributed to a lot of progress, but for two reasons it became clear that this was not a satisfactory general-purpose standard, namely:

- because all possible situations — plausible or implausible — (of a class) were given equal attention, and

- there was no workable way to try to approach optimality.

The next stage, still under active development, was that of robust/resistant techniques, where, in one style at least, we still called for satisfactory performance against each of a diversity of challenges — hopefully including all the very plausible ones — and most of those reasonably plausible. Because the diversity is limited, it has proved possible to have a workable — though not highly formalized — approach to optimality.

Two kinds of approaches to such problems have developed:

- the use of numerical-calculation mathematics in connection with each of a small number of situations, and
- the use of formula-manipulation mathematics, for "neighborhoods of some utopian situation as  $n \rightarrow \infty$ ", leading to the proof of theorems.

Fortunately, those leading both of these approaches are keenly cognizant of the diversity of criteria that need to be considered in actual practice. Since both sides have avoided, as a consequence, taking either empirical optimization — here polyoptimization — or theorems as the only precise basis for determining what an analyst of data should do, these two approaches have developed in amity. More and more robust/resistant techniques are appearing. Some of us dream of the day when there will again be a standard core of techniques — this time robust/resistant in character.

Philosophically, there is an interesting parallel between robust/resistant techniques and ideas of what an efficient information-using human would do. The idea of a "rational man", who optimizes every last decimal — of whom instances were so hard to find — has begun to be replaced by that of a "satisficing man," of one who tries to get — and hopefully succeeds in getting — close enough to each of a variety of optima.

In general data analysis, then, the aim of doing quite well in the face of a diversity of challenges is now the gleam in the theorist's eye.

### Back to Covert Spectrum Analysis

The more realistic (in my view) and less violently covert user of spectrum analysis, who wishes to take advantage of current insights applying to general data analysis, thus naturally fixes his dreams on some sort of robust/resistant few-parameters spectrum analysis even though there is, as yet, insufficient foundation to establish, to general agreement, just what sort of such analysis should be our common ideal.

If our boundedly covert analyst is content with a combination of useful general guidance and some personal freedom to choose details, we have given him/her both a reasonable (if somewhat hazy) utopia on which to fix his/her eyes and some reasonably satisfactory techniques to use in practice.

The more deeply covert spectrum analysts will not be satisfied by anything as soft as what we have described. Their lack of ease (perhaps to be abbreviated as "disease") is a desire for a straitjacket. Before we turn to them in more

detail, however, we should discuss the integration of overt and covert spectrum analysis.

### Combining the Flavors

Physical science is used to an alternation of processes of discovery and refinement. We are not ready to refine our knowledge of some phenomenon until we have discovered it. Equally, we are not too likely to discover the next phenomenon until we have refined our knowledge of the related phenomena already discovered.

This, when applied to spectrum analysis, leads us to the following sequence:

- 1) Initial overt analysis, hopefully reaching a reasonable model involving a reasonable number of coefficients (and thus a narrow model).
- 2) Repeated covert analysis, using a carefully chosen narrow model, intended to make us understand, as quantitatively as possible, how the few constants in the model depend — or seem uninfluenced by — the many, many factors of which we had not earlier taken account.
- 3) Another spell of overt analysis, trying to sniff out new phenomena or just to identify how the current model fails most seriously.
- 4), 6), 8), ... (like 2)
- 5), 7), 9), ... (like 3).

Failure to use either overt or covert spectrum analysis in each's appropriate place will cost us. Failure to use overt spectrum analysis can cost us lack of new phenomena, lack of insight, lack of gaining understanding of where the current model seems to fail most seriously (what greater costs can there be? — more specifically, perhaps, what losses can be harder to remedy?). Failure to use covert spectrum analysis can cost us inefficiency — keep us from getting forward as far as we might on the basis of given data — force us to collect and analyze more data than would otherwise be required. (In economic terms, such costs may be high. In strategic terms, they only demand more resources — given adequate resources, they do not restrict our progress.) We need both overt and covert. We would be unwise to skinch on either. (But if we were forced to keep one, which fortunately we are not, we ought to keep the overt.)

Anyone who agrees with such conclusions can only have deep regret for the tendency of electrical engineering, for one, to emphasize the covert to the near total exclusion of the overt. (The *Special Issue on Spectrum Analysis* about to appear in the *Proceedings of the IEEE* (various authors, 1982) is rumored to contain only papers on covert techniques.)

### The Extreme Search for a Straitjacket

Who asks for the most extreme straitjacket? Those who want to be told — by something "deeper" than a desire to optimize performance, whether in one or several situations — *exactly* what they should do. Where do the principal protagonists seem to have drunk in their desires for such strict straitjackets? Surely not in their mother's milk, but possibly in the courses and practice of theoretical physics.

One form of this view seems to come from an attempt to carry over an immensely successful logic which has taught us

much about physical phenomena — both deterministic and probabilistic — to data. But data, as actually collected, are not merely physical phenomena. They have — in every situation we have seen, and in every situation I can envisage — intrusions of human actions and irrelevant noise — always at least minor, but often major.

Moreover, data comes from instruments (in economics and politics the instruments may be made up of people). Instruments are designed (or at least made) by people. "Small" changes in design can substantially alter the character and frequency of instrumental misbehavior. Instruments are maintained by humans — so there can be no surprise when we learn that most instruments are in far-from-perfect shape. Once upon a time, all instruments were read by humans, and both data handling and computation were by humans. (We have reduced human intervention and machine errors, often drastically, but we have done most of this by inserting a further layer of instruments, called A-to-D converters.)

While there may be a single correct probability structure for a rather broad class of instances of statistical physics, it is most unlikely that there will be a single correct (or even adequate) probability structure for a similar class of instances of collected data.

The apparent logic of theoretical physics, which has emphasized Occam's Razor and Newton's *hypotheses non fingo* through an emphasis on simple, basic, widely embracing hypotheses, has been of unquestioned value in statistical physics as well in the deterministic physics where it arose. The seductive power of the idea of transferring it from the statistics of physical phenomena to the statistics of data is hard to overestimate.

But the wisdom of this transfer is hard to support. The non-physical aspects of data are important enough — particularly the human aspects we have just sketched — that there does not seem to be any bridge capable of bearing our weight — surely not mine!

Success in one field is no guarantee of success in another. Clearly, the nearer the two fields the greater the hope of success.

Today, what might be called the "strategy of theoretical physics" is seen to fail, at least as practiced by Fisher, Neyman and Pearson — not succeed — in the field of general data analysis. The "strategy of robust/resistance" is seen to serve us much better. And, surely the field of general data analysis is much closer to the field of spectrum analysis (with some error in the data) than is even the subject of statistical physics. If we must argue by analogy, we should choose the closest analogy.

Some listeners may think that I am attacking a straw man. But I know too many able people who are content with the argument that in spectrum analysis where the data is free of error:

- we must have an analysis that exactly matches the data for the values of a certain set of functions (rather symmetric) of the observations, and that
- in choosing among the many solutions of such matching, there is a moral obligation to choose the solution of some extremal problem, preferably one reminiscent of physics, and, often

- that a reasonable choice is the result of maximizing the entropy of the distribution of power for the resulting estimated spectrum.

I see no obligation to go that way. What I do see is an obligation on those who do go that way to explain why it has been helpful for them.

Too many, again, extend their error-free conclusions to the case (is there any other in practice?) where there are some errors. Now these (fool)hardy few are open to challenge as to how their techniques perform in comparison with other techniques. Collectively, statisticians ought, long ago, to have begun to try out various techniques comparatively here. (In particular, *mea culpa*.)

### What is a Spectrum?

I recently asked a very intelligent protagonist of maximum entropy in the no-error case — a man too intelligent to expect these methods to work well without change in the errors-present case — what the spectrum of a no-error function known only by a finite sequence of values, say

$$y_0, y_1, y_2, \dots, y_T$$

was. He was careful enough to say that he would want to work with one or more choices for a while, but he did say that his off-hand feeling favored the coefficients in a finite Fourier expansion.

Those who have suffered with the various kinds of Fourier transforms would recognize that (end terms aside) he was suggesting a spectrum confined to the angular frequencies

$$k\pi/T \quad 0 < k \text{ integer} < T/2.$$

This of course means that losing one observation would move the power to frequencies

$$k'\pi/(T-1) \quad 0 < k' \text{ integer} < (T-1)/2,$$

no one of which coincides with one of the earlier set.

Such a definition of the spectrum would hardly satisfy anyone who has done practical spectrum analysis.

I don't take this story as criticizing my friend for such an offhand suggestion. Much more importantly, it illustrates that finding a bearable definition of "a spectrum" for a given piece of data is very difficult. (Finding a definition of "the spectrum" is more difficult yet!)

My own opinion, which takes much more time to support than I dare take here, is that defining "a spectrum", even in the errorless case, involves embedding the data before us in a larger whole — a whole so large that what we see is negligible by comparison with the rest!

Among such embeddings, those making explicit uses of probability seem to me to be the simplest — and are surely far from being the most complicated — so I believe that the most useful definitions of a "spectrum" are, probably, some of those involving probability.

### Back to Geophysics and Walter Munk

There is an example of "Munkery" which gives a quite different reason for our being unwilling to confine ourselves

to covert spectrum analysis. It involves the final successful conclusion of Walter's search for edge waves, pursued in far distant places. In the article in the *Journal of Fluid Mechanics* (Munk, Snodgrass and Gilbert, 1964) where the data was subject to a double analysis — frequency and inverse wavelength — the real solidity of the match between theory and observation was the *repeated* location of the observed peaks — in the frequency-wavenumber plane — along the modes predicted by the paper's theory. The strength of this match was much greater because the analysis was a simple overt one — one that guarantees that what was observed (by calculation) in one frequency-wavenumber neighborhood was reasonably independent of what went on — either in the analysis's output or in the real ocean — at other neighborhoods.

If a covert analysis had been used, it is not likely that we could have been sure of such reasonable independence — which, in fact, we might not have had. The probative value of such a covert analysis would not have been anywhere nearly as strong! Only an overt, or nearly overt, analysis could have provided the strong evidence that Munk *et al.* gave us. It is a general property of covert analyses that they cannot give us several reasonably independent pieces of evidence from a simple analysis of all of a given body of data. It is a great virtue of overt analyses that they sometimes can do this.

### Message

Best wishes to Walter and many happy returns of the day.

### Acknowledgements

Prepared in part in connection with research at Princeton University, sponsored by ARO(D).

### References

- Fisher, R.A. 1935. *The Design of Experiments* (1st edition), Hafner, 248 pp.
- Munk, W.H. and F. Snodgrass. 1957. Measurements of southern swell at Guadalupe Island, *Deep-Sea Research*, 4, 272.
- Munk, W.H., G.R. Miller, F.E. Snodgrass and N.F. Barber. 1963. Directional recording of swell from distant storms, *Phil. Trans. Roy. Soc. London*, A 255, 505.
- Munk, W.H., F. Snodgrass and F. Gilbert. 1964. Long waves on the continental shelf: an experiment to separate trapped and leaky modes, *J. Fluid Mech.*, 20, 529.
- Student. 1927. The errors of routine analysis, *Biometrika*, 19, 151.
- Various authors. 1982. *Proc. IEEE*, 70, 883. (Special issue on spectral estimation, September 1982.)

# SOUND TRANSMISSION THROUGH INTERNAL WAVES, INCLUDING INTERNAL-WAVE TOMOGRAPHY

Stanley M. Flatté

*La Jolla Institute Center for Studies of Nonlinear Dynamics  
La Jolla, California 92037  
(on leave from University of California, Santa Cruz)*

## Abstract

A short personal history of the development of the theory of sound transmission through internal waves is given. The theory is used to develop a method for determining the geographical distribution of internal-wave strength by acoustic tomography. It is shown that fluctuations of acoustic travel-time over time scales of order one hour can be used to probe low-mode internal waves, whereas fluctuations of arrival angle measured by vertically separated hydrophones will probe high-mode internal waves.

## Prologue

In honor of Walter Munk's 65th Birthday

*Down to the wine-dark sea strode Munk,  
And slapped the water with a mighty thunk.  
The sound traversed to a distant shore;  
"The oceans are transparent." The admirals roared.  
But when they took a closer look  
The image before them quivered and shook.  
"Nuts!" They said, "We can't find subs."  
And repaired forthwith to the nearest pub,  
Where, gazing through a glass of beer,  
Walter winked, and without fear  
Cried out: "You've missed the point, my friends!  
The distortion you've seen and now lament  
Is opportunity knocking; it gives us pause.  
The key is in asking what's the cause;  
Is it moon and tides, or swimming fish,  
Or is it instead, just my dish;  
The idea that our day will save:  
The ocean is filled with internal waves!*

The subject of my talk is the connection between internal waves and ocean acoustics, a field to which Walter Munk has devoted nearly the last ten years of his research effort. But first I would like to recount an anecdote about my first contact with Walter.

About 20 years ago I was a graduate student in experimental particle physics in the group led by Luis Alvarez. Having been lured into being a student member of Sigma Xi, I had the habit of reading the *American Scientist*, and an article

there interested me in the figure of the earth. Inspired by a few nights of reading through Jeffreys (1959), I took six months away from my particle physics research to investigate the relation between sea level and hydrostatic equilibrium of the solid earth.

On Luis' suggestion, I sent a draft of my work to Walter Munk; Luis said he would know something about these subjects. Walter demonstrated a number of his great strengths as a scientist by sending me a polite letter saying the work looked interesting, and avoiding any further involvement. The paper eventually achieved its burial place (Flatté, 1965) in the depths of *JGR*, and I went back to 15 years of particle physics.

I didn't come into contact with Walter again until I joined the Jason group in 1970, and didn't work directly with him until late 1973, when a collaboration began on the subject of this talk; the connection between ocean acoustics and internal waves.

This discussion is divided into three parts; the prologue above, a bit of history of the work on the connection between acoustics and internal waves, and an offering of a new idea that I think provides an exciting direction for the community interested in ocean structure and tomography.

## History

Late in 1973 or early in 1974, I remember Walter and Ken Watson coming to me as a young man familiar with the capabilities of large-scale computing, and explaining their opinion that two recent advances had created a new opportunity. The first advance was the Garrett-Munk spectrum of internal waves that Chris Garrett (1983) discussed yesterday. The second advance was the introduction into underwater acoustics of a new method of computer wave propagation — the parabolic equation method of Fred Tappert (1974), then of Bell Telephone Labs, soon to move to Courant Institute, and now at University of Miami. The method could handle fluctuations in the ocean that are range-dependent, an important new consideration at that time. The resulting opportunity was to obtain an understanding of acoustic fluctuations caused by internal waves, with the hope that many Navy sonar observations of acoustic fluctuations could be explained

by internal waves, or, at least, that we would be calculating the fundamental limitations imposed by the ocean on the practical use of sound transmission.

It is important to describe the attitudes of the different scientific communities involved in these phenomena at that time. The oceanographers, I am told, were reasonably certain that internal waves existed with significant energy levels in the open ocean, even though no experiment had yet shown the cutoff at the buoyancy frequency in a really convincing way. After all, the ocean is stratified. On the other hand the acoustic community was dealing with a problem in wave propagation. The history of wave propagation is a story in itself (Flatté, 1983), but suffice it to say that wave propagation theory was dominated by results of people working with light through the atmosphere, and these results were specialized to straight paths through homogeneous, isotropic turbulence. When an acoustician was faced with the record of a towed thermistor through the ocean, he, therefore, immediately suggested that the observations corresponded to homogeneous, isotropic turbulence. After all, if it were internal waves, all the known theories of wave propagation were essentially useless. A theory of propagation through internal waves was needed.

So Fred Tappert and I began that summer of 1974 hoping that we would at least get a code written by the end of a summer study at the Bishop's School, and at the same time Fred Zachariassen and Roger Dashen joined Walter and Ken in thinking about analytical techniques to solve the same problem. I guess Fred and I felt pushed, because every week those four would come into our office with some question about what the propagation would "really look like". For example, did rays retain their character after travelling 1000 km in the fluctuating ocean? In any case, within a month we

were covering the floor of a large room with computer-graphical printout. As we walked around and over our computer ocean, we began to understand what internal waves do to sound.

Figure 1 shows a typical sound-speed profile as a function of ocean depth, along with rays emanating from a source on the sound-channel axis. Figure 2, from Flatté and Tappert (1975), shows the structure in vertical angle of arrival of sound received by an array hung at considerable range from the source. Rays are clearly visible, though they fluctuate because of the internal-wave motions in this computer ocean. These graphs were some of the first results from the parabolic equation method in underwater acoustics, and they helped establish the method as an indispensable tool. The computer in this case was being used as an exploratory tool, not to give pages and pages of numbers, but to achieve the qualitative understanding that formed the basis from which quantitative analytical theories could be developed. The first success in this area was achieved by Munk and Zachariassen (1976) whose absolute calculations of variances in phase and log-intensity from internal-wave effects were within a factor of two of the available experimental results. The path-integral approach for use in the saturated region was introduced by Dashen (1979). Much more detailed comparisons with theory and experiment were carried out over the next three summers, finally culminating in our monograph on the subject (Flatté *et al.*, 1979). A description of progress in this field since publication of the monograph is contained in Flatté (1983).

#### Internal-Wave Tomography

I would now like to combine two recent advances to create a new opportunity! The first advance is the development of a

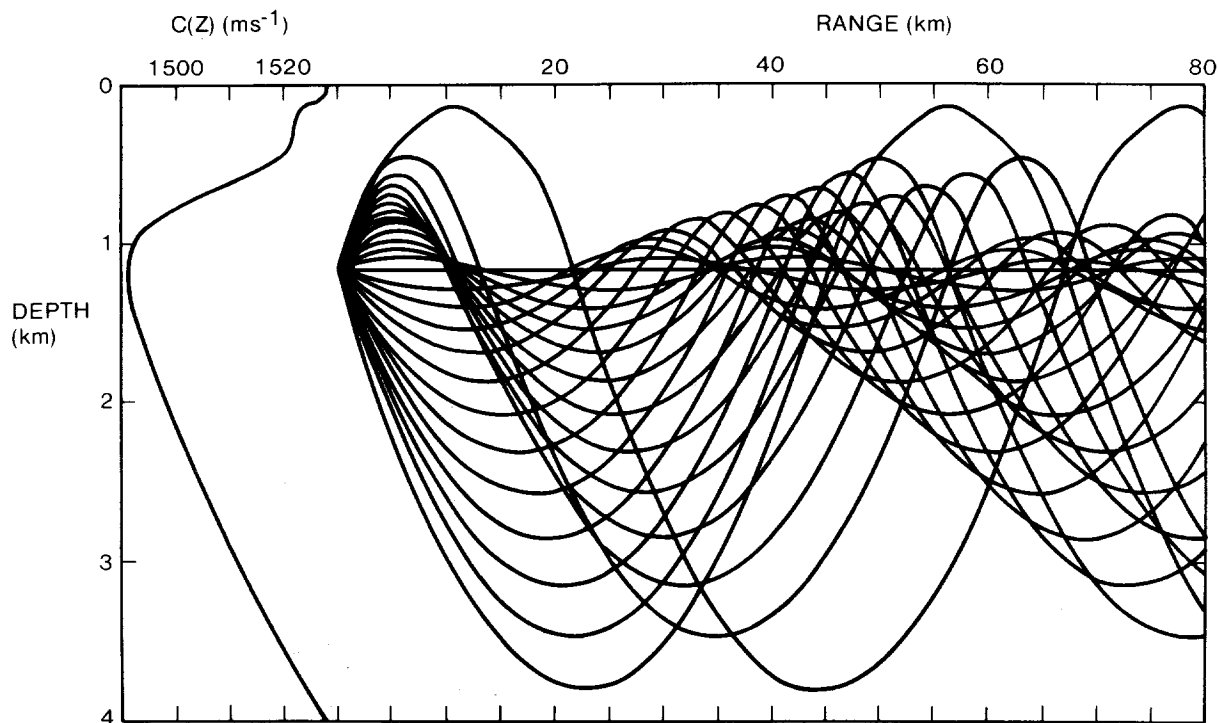

Figure 1. Sound-speed profile and some typical rays from a source on the sound axis. The profile is taken from an area off Bermuda at approximately 26°N, 70°W.

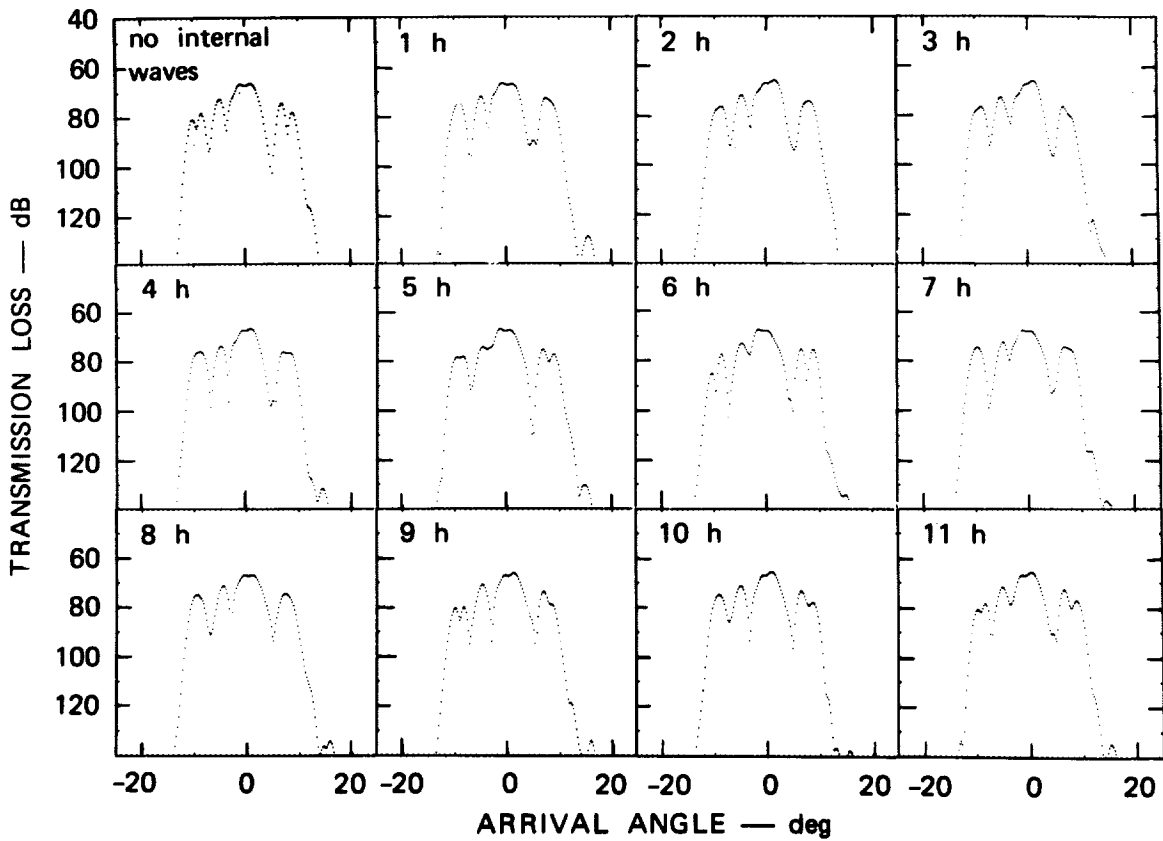

Figure 2. Computer simulation of intensity as a function of vertical arrival determined by a 700-m vertical array of hydrophones centered on the sound channel axis at a range of 250 km from a 100 Hz source on the axis. The profile used was an analytic one with sound channel axis at 1 km depth. (Taken from Flatté and Tappert, 1975.)

reasonably sophisticated understanding of wave propagation through internal waves (see above). The second advance is the development of ocean acoustic tomography pioneered theoretically by Munk and Wunsch (1979). The first experimental results have been reported by The Ocean Tomography Group (1982). The opportunity I will call the tomography of internal waves.

Figure 3 shows schematically a section of mesoscale activity in the ocean, with a set of rays from several acoustic sources and receivers such as might be used in a tomography experiment. We would like to ask a question whose answer is not well known at present: what is the geographical distribution of internal-wave strength on the scale of Figure 3? An additional interesting question would be: how is that internal-wave field correlated with mesoscale features such as warm or cold eddies, or fronts? The connection between the internal-wave field and the mesoscale features of the atmosphere is a further item of interest.

There is a wealth of theoretical questions that arise from consideration of the geographical distribution of internal-wave energy, mostly involving transport of energy and other quantities from one ocean process to another. We will not explore these ideas; we will concern ourselves solely with the opportunities provided by acoustic tomography for measuring the internal-wave field. We shall find that the overall energy level of internal waves as a function of geographical position can be measured in a simple manner, and that more ambitious experiments involving vertical arrays of hydrophones could determine the entire internal-wave spectrum.

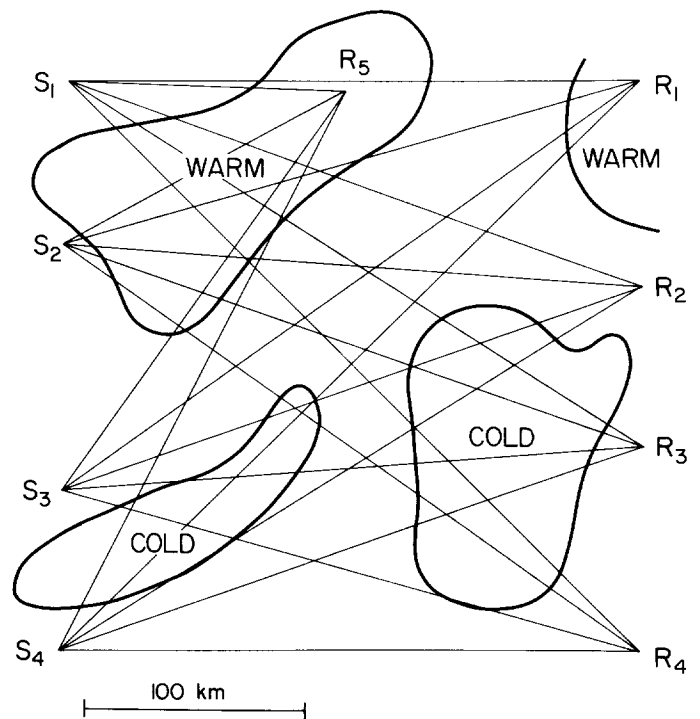

Figure 3. A schematic of mesoscale ocean structure with an example of a set of rays in a tomography experiment.

The essence of tomography, at least of the "linear" variety, is the identification of an observable as a line integral of the desired field. For example, in the ocean acoustic tomography of Munk and Wunsch (1979), the relation is

$$T(t) = \int_0^R C^{-1}(\mathbf{x}, t) ds \quad \mathbf{x} = (x, y, z) \quad (1)$$

where the observable  $T$  is the travel time of an acoustic pulse along a ray between a source and receiver separated by range  $R$ . The field of interest is the sound speed  $C(\mathbf{x}, t)$ , and it is understood that the integral is taken along the curved ray. The variable  $t$  is geophysical time. The whole mathematical apparatus of tomography is bought to bear on (1) in order to deduce  $C(x, y, z, t)$  from observations of  $T(t)$  for a large number of rays. For the observation of mesoscale eddies, the changes in  $T(t)$  are observed over times of order ten days or more, and the mean  $C(\mathbf{x}, t)$  is determined.

We will not discuss the details of tomographic mathematics here. Rather, we will show how certain acoustic measurements are cast into a form similar to (1), in which the field integrated has to do with internal waves. One can then conclude that the internal-wave field can be determined by tomographic techniques completely analogous to those used for mesoscale eddies.

Imagine watching the observable  $T(t)$  over a period of a few minutes, rather than averaging it for ten days. Fluctuations in  $T$  will be observed, and it has been well established that for acoustic frequencies of several hundred Hertz, these fluctuations are caused by internal waves.

At this point it will be useful to switch from considering  $T(t)$  to considering the received wavefunction

$$\Psi(\mathbf{x}, t) = A(\mathbf{x}, t) \exp[i\phi(\mathbf{x}, t)] \quad (2)$$

where it is assumed that the transmission is essentially CW: that is, a single frequency. In the simplest wave propagation theory, the phase  $\phi(\mathbf{x}, t)$  can be directly identified with  $\sigma T(t)$  where  $\sigma$  is the center frequency and  $T(t)$  is the travel time of an acoustic pulse from the source to the point  $\mathbf{x}$ . However, wave propagation theory is not always so simple, as we will see later.

Let the total sound speed  $C(\mathbf{x}, t)$  be expressed as

$$C(\mathbf{x}, t) = C_0[1 + U_0(z) + \mu(\mathbf{x}, t)] \quad (3)$$

where  $C_0$  is a reference sound speed,  $U_0(z)$  represents the deterministic sound channel that causes rays to curve as in Figure 1, and  $\mu(\mathbf{x}, t)$  is the fractional sound speed variability due to internal waves. Then it is a simple exercise to show from (1) and the assumption that  $\phi(\mathbf{x}, t) = \sigma T(t)$  that

$$\langle (\phi(\Delta t) - \phi(0))^2 \rangle = q^2 \int_0^R ds \int_0^R ds' \langle (\mu(s, \Delta t) - \mu(s', 0))^2 \rangle \quad (4)$$

where the angle brackets indicate an ensemble average over realizations of the internal wave field.

The key to internal-wave tomography is the realization that the correlation length of the internal wave field is less than 10 km, far smaller than the range  $R$ . Then the second integral can be treated as a local function, called the phase

structure function density, whose evaluation for internal waves has been carried out by Esswein and Flatté (1981):

$$\langle (\phi(\Delta t) - \phi(0))^2 \rangle = \int_0^R ds d(\Delta t; \theta, s) \quad (5)$$

$$d(\Delta t; \theta, z) = 2q^2 \langle \mu^2(s) \rangle L_P(\theta, s) f(\Delta t; \theta, s) \quad (6)$$

$$\langle \mu^2(s) \rangle = \zeta_a^2 \frac{n_a}{n(z)} (C^{-1} \partial_z C - \gamma_A)^2 \quad (7)$$

$$L_P(\theta, s) \approx \frac{4}{\pi^2} \frac{n_0 B}{\omega_i} \left\langle \frac{1}{j} \right\rangle \left[ 1 + \frac{n^2}{\omega_i^2} \tan^2 \theta \right]^{-1} \quad (8)$$

$$f(\Delta t; \theta, s) \approx \frac{\omega_i^2}{2} \left[ 1 + \frac{n^2}{\omega_i^2} \tan^2 \theta \right] (\Delta t)^2 \quad (9)$$

where  $q = \sigma/C_0$  is the acoustic wavenumber,  $L_P$  is an internal-wave correlation length along a line tangent to the ray at position  $s$  (hence its dependence on  $\theta$ , the ray angle with the horizontal), and  $f$  is called the phase correlation function. Equations (7-9) represent approximations to some of these quantities in terms of internal-wave properties. More exact expressions are given in Esswein and Flatté (1981). The equation for  $\langle \mu^2 \rangle$  makes a WKB assumption about the vertical dependence of the internal-wave displacement,  $\zeta$ :

$$\langle \zeta^2 \rangle \approx \zeta_a^2 \frac{n_a}{n(z)} \quad (10)$$

where  $\zeta_a$  is the rms displacement for a reference buoyancy frequency  $n_a$ . The sound speed variance  $\langle \mu^2 \rangle$  is then the displacement variance times the square of the gradient of potential sound speed. ( $\gamma_A$  is the adiabatic gradient of sound speed). The quantity  $n_0 B$  appearing in the expression for  $L_P$  is from the dispersion relation of internal waves relating frequency and both horizontal ( $k$ ) and vertical ( $k_V$ ) wavenumber:

$$k = \frac{\pi j}{n_0 B} (\omega^2 - \omega_i^2)^{1/2} \quad (11)$$

$$k_V = \frac{\pi j}{n_0 B} n(z) \quad (12)$$

and  $j$  is the mode number. The expression for  $f$  is an approximation applying to small  $\Delta t$  (usually, less than several hours).

Combining the above equations we can express (5) as

$$\langle (\phi(\Delta t) - \phi(0))^2 \rangle = q^2 \int_0^R ds \zeta_a^2 \left[ \frac{4}{\pi^2} \left( \frac{n_0 B}{\omega_i} \right) \left\langle \frac{1}{j} \right\rangle \frac{n_a}{n(z)} (C^{-1} \partial_z C - \gamma_A)^2 \omega_i^2 \right] (\Delta t)^2 \quad (13)$$

We can express (13) in terms of the fluctuation in travel time  $\delta T$  over a time interval of  $\Delta t$ :

$$\langle (\delta T)^2 \rangle = \int_0^R ds \zeta_a^2 \left[ C_0^{-2} \frac{4}{\pi^2} \left( \frac{n_0 B}{\omega_i} \right) \left\langle \frac{1}{j} \right\rangle \frac{n_a}{n(z)} (C^{-1} \partial_z C - \gamma_A)^2 (\omega_i \Delta t)^2 \right] \quad (14)$$

In the first place, (14) is in the form of (1), so that tomography can be applied. To make the system more practical, we

take the point of view that *the quantity in square brackets is known*; that is, the profiles of buoyancy frequency and sound speed are known in the geographical area of the experiment. Then the only unknown is the displacement variance of internal waves  $\zeta_a^2$ , which we regard as the unknown function of geographical position to be determined from tomography.

It is of interest to note that the quantity in square brackets is independent of  $\theta$ ; that is, internal-wave anisotropy has not had any effect on this observable. This arises because when  $\Delta t$  is small, only high frequency internal waves affect the result, and these waves have very little anisotropy. An exact calculation of this quantity from (6) is given in Figure 4, showing that indeed the dependence on angle is slight. Figure 4 applies to the geographical area of the 1981 Tomography Experiment (Worcester, 1983), where it is seen that the main contributions along a ray will come when that ray is at a depth between about 400 and 900 m. Table I gives some examples of calculations for the observable travel-time fluctuation in a practical tomographic example; in fact the source-receiver pair is one that actually was used in the 1981 Tomography Experiment. The examples assume that the ocean has a uniform  $\zeta_a = 7.3$  m; the purpose of a tomography experiment would be to observe the variations in  $\zeta_a$ . The rms travel-time fluctuation for  $\Delta t = 2$  min is typically about 0.2 ms. Accuracies over this short time scale for sources and receivers that are tracked with transponders should be in the neighborhood of 0.1 ms or less, if phase is measured, so that errors in the determination of  $\delta T$  down to

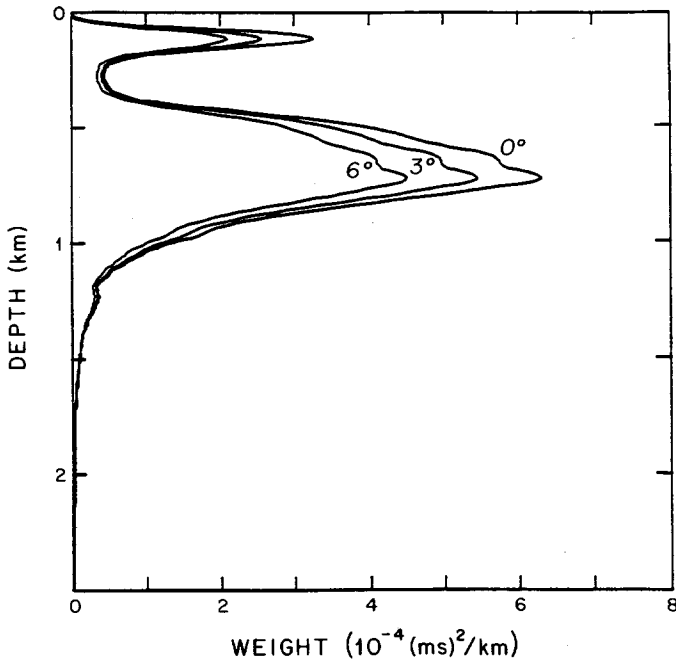

Figure 4. The weighting function for internal-wave tomography of travel-time fluctuation from (5-6). The calculation has used the sound-speed and buoyancy from the 1981 Tomography Experiment. For reference an internal-wave rms displacement of 7.3 m, and a  $\Delta t$  of 2 minutes have been taken. The integral of this function along the curved ray from source to receiver will give the predicted variance of travel-time between two observations 2 minutes apart. Note that the dependence of the function on ray angle is rather weak, in accordance with the approximation represented in (13, 14).

Table I: Parameters of rays from a source at 2120 m depth to a receiver at 1700 m depth and at 327 km range. The sound-speed and buoyancy profiles used were from the 1981 Tomography Experiment (Worcester, 1983). The Garrett-Munk spectrum is assumed with  $\zeta_a = 7.3$  m. Only rays with upper turning points between 400 and 900 m depth have been selected as being most appropriate for measuring internal waves. The turning point depth is  $z_a$ , the number of upper turning points is N, the unsaturated prediction for travel-time fluctuation for a time interval of 2 minutes is  $\delta T$ , and the prediction for rms arrival-angle fluctuation is  $\delta\theta$ .

$z_a$ (m)	N	$\delta T$ (ms)	$\delta\theta$ (deg)
761	8	0.18	0.50
700	7	0.18	0.40
598	7	0.19	0.65
530	6	0.18	2.41
398	6	0.18	0.28
433	5	0.17	0.31
507	6	0.18	0.55
629	6	0.18	0.91
679	7	0.18	1.21
746	7	0.17	1.54
786	8	0.17	1.39

a time separation of a few minutes will be dominated by statistical uncertainty rather than systematic error. For example, a measurement of  $\delta T$  every two hours for ten days along one ray would yield a percentage error in  $\langle (\delta T)^2 \rangle$  of about 10%.

As indicated in (14)  $\delta T$  is linear in  $\Delta t$ , so that it might seem very advantageous to increase  $\Delta t$  from 2 min to a much larger amount, say 2 hr. However, this is not directly feasible because the transmissions are predicted to be in the saturated region, so that the phase decorrelation time is very short (typically 10 min.). Nevertheless, observations at 2 hr intervals can be used; this is discussed in Section 5.

Thus the tomography of travel-time fluctuations will measure the field of internal waves, weighted toward low vertical wavenumber. The weighting will also be toward high frequency if  $\Delta t$  is small. It remains to be calculated how well tomography of internal waves will work with a given level of accuracy in these measurements.

#### Arrival-Angle Fluctuations

The above examples of travel-time fluctuations have assumed the use of one receiver, and as a result internal waves of all vertical scales contribute to the observed fluctuations. That is the origin of the  $\langle 1/j \rangle$  term in the weighting function of (13). Since most of the internal-wave energy resides in the low modes, the  $\delta T$  observable will be dominated by the low modes.



Suppose we now consider two receivers separated by a small vertical distance  $\Delta z$ . The rays from the source to these two receivers might look like those in Figure 5a. The phase difference between these two receivers can be related to the scaled angle,  $\alpha$ , which can be thought of as an effective arrival angle of the sound ray (Fig. 5b).

$$q\Delta z \sin\alpha = \Delta\phi \quad (15)$$

and thus a variation in arrival angle would be related to a variation in  $\Delta\phi$  by

$$\delta\alpha \approx \frac{1}{q\Delta z} \delta(\Delta\phi) \quad (16)$$

Actually  $\alpha$  is not the arrival angle of directed energy necessarily, due to saturation (see next section), but it serves the same purpose for a vertical array of hydrophones.

Because the two rays never have much vertical separation, this phase difference  $\Delta\phi$  will emphasize higher-mode internal waves: those whose vertical wavelength is comparable or smaller than  $\Delta z'$ . The variance of vertical arrival angle can be expressed as

$$\langle(\delta\alpha)^2\rangle \approx \frac{1}{(q\Delta z)^2} \int ds d(\Delta z'; \theta, s) \quad (17)$$

which is approximately

$$\langle(\delta\alpha)^2\rangle \approx \int ds \xi_a^2 \left[ \frac{n_a}{n(z)} (C^{-1}\delta_z C - \gamma_A)^2 \frac{8}{\pi^2} \frac{n_0 B}{\omega_i} \left\{ 1 + \frac{n^2}{\omega_i^2} \tan^2\theta \right\}^{-1} \cdot \langle j^{-1} [1 - \cos\beta j] / (\Delta z)^2 \rangle \right] \quad (18)$$

$$\beta = \pi n \Delta z' / n_0 B \quad (19)$$

Again everything in square brackets is approximately known. It is useful to note that the right hand side of (18) is independent of acoustic wavenumber  $q$  and only logarithmically a function of  $\Delta z$ . A plot of the integrand of (18) is given in Figure 6 showing again a strong peak near 700 m, but now exhibiting very strong dependence on ray angle. The weighting along the ray is now very experiment dependent, because  $\Delta z'$  is a function of  $x$ , controlled by the deterministic sound channel. Nevertheless an order-of-magnitude approximation for rms  $\delta\alpha$  (see the rays in Table I) is about  $1^\circ$ . Figure 7 shows some observations of  $\delta\alpha$  every two hours for two months, and illustrates that the accuracy of observation should be adequate for determining  $\delta\alpha$  to 10%. The effect on  $\delta\alpha$  from mooring tilt should be small.

Thus tomography of arrival angle fluctuations will measure the field of internal waves, weighted toward high vertical wavenumber.

### The Saturated Regions

The analysis presented in the previous two sections has been done under the restrictive assumption that there is a one-to-one correspondence between the phase of the received wavefunction and the travel time of a short pulse. This assumption is equivalent to the validity of geometrical optics, and its region of validity is called the unsaturated region because intensity fluctuations are small. If the medium fluctuations are strong enough, this correspondence breaks

down; a single distinct pulse at the transmitter may arrive as several pulses at the receiver, because the fluctuations have created new rays.

(a)

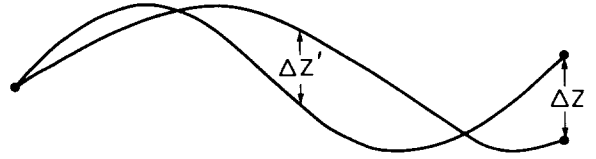

(b)

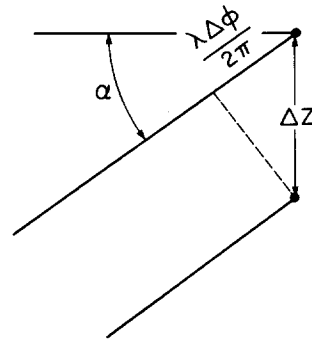

Figure 5. Determination of arrival-angle fluctuations. (a) Rays from a source to two hydrophones separated vertically by  $\Delta z$  is a complicated function of range due to the sound channel. (b) The relation between phase difference  $\Delta\phi$  and arrival angle  $\theta$ .

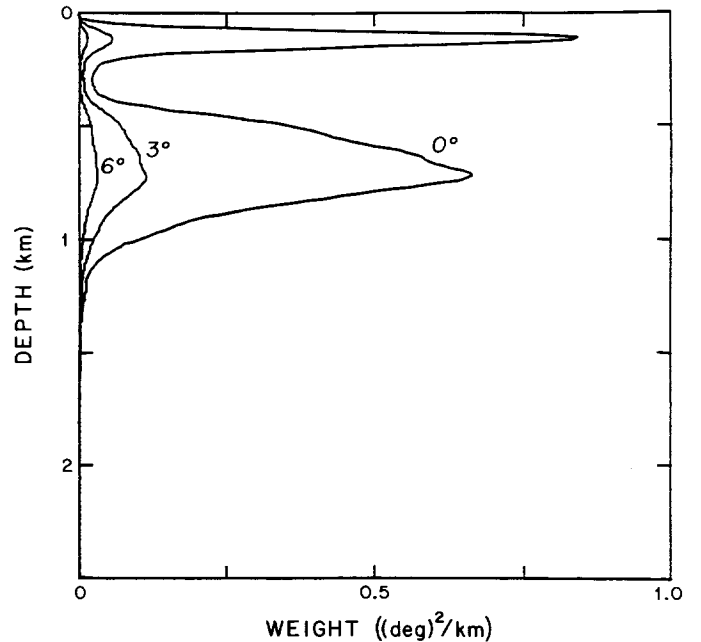

Figure 6. The weighting function for internal-wave tomography of arrival-angle fluctuations from (18). Parameters are the same as in Figure 4. The strong dependence on ray angle is evident.

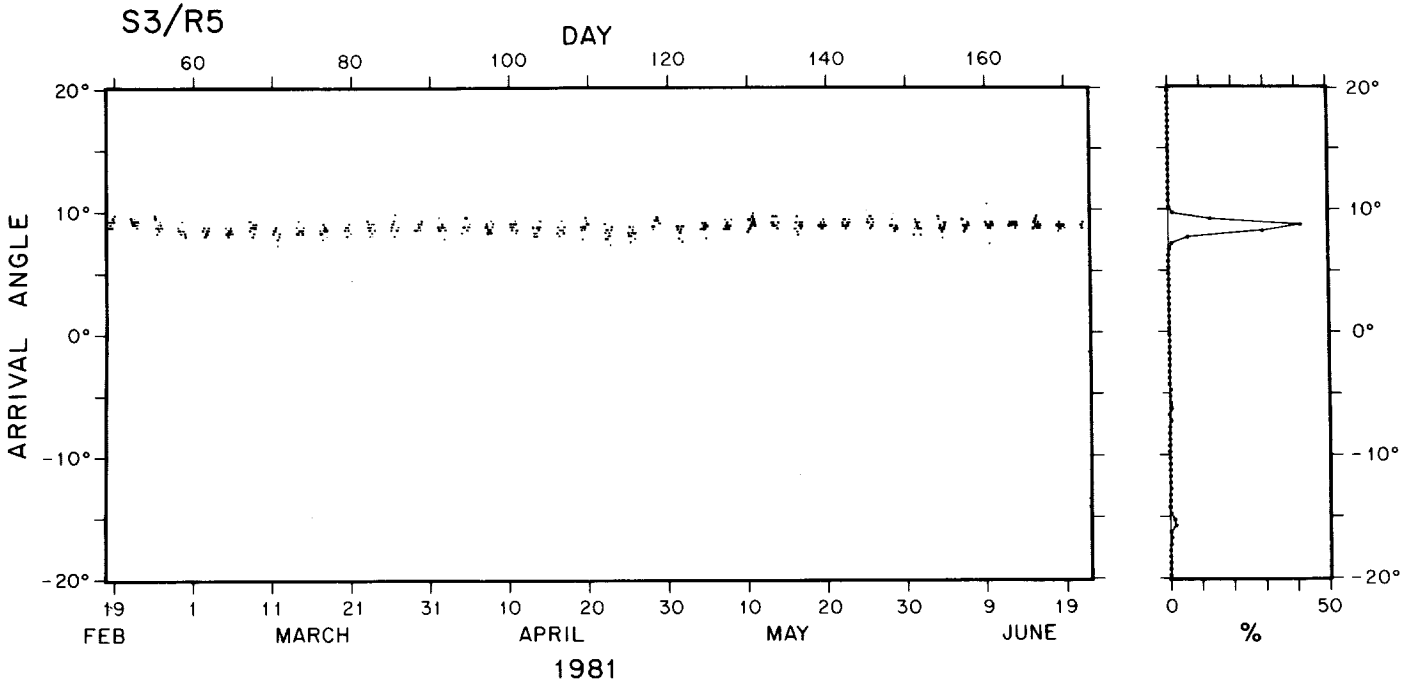

Figure 7. Observed arrival-angle fluctuations over a 229 km path at 220 Hz (P. Worcester, 1983).

In this case the intensity fluctuations of a CW transmission become comparable to unity, and because the intensity fluctuations do not rise much above unity for very strong fluctuations, this is called the saturated region. Flatté (1981) has shown that it is nevertheless possible to determine acoustically the right hand sides of (14) and (18); however, the method requires use of both amplitude and phase rather than just phase. The rule is actually simple. A variance of phase difference is replaced by:

$$\langle (\phi(\mathbf{x}, t) - \phi(\mathbf{x}', t'))^2 \rangle \rightarrow -2 \ln \langle \Psi^*(\mathbf{x}, t) \Psi(\mathbf{x}', t') \rangle \quad (20)$$

Thus tomography can be accomplished in the saturated regions as well.

However, (20) is not of practical use if  $\Delta x$  or  $\Delta t$  get so large that the correlation of  $\Psi^* \Psi$  is lost in the noise. In the case of a 300 km ray at 220 Hz, this will occur for  $\Delta t$  values of 10 minutes or so, and  $\Delta z$  values of several tens of meters. Measurements of the arrival angle with hydrophones separated by 10 m, as in the 1981 Tomography Experiment, will still follow the prediction of (17), and measurements of phase difference over time intervals of 2 minutes follow (5).

Measurement of phase difference for time intervals greater than a few minutes must account for saturated phasor behavior. Equation (20) implies that the phase will become completely random after about ten minutes, so measurements over 2 hr intervals are useless. However, measurements of travel time of a pulse involve a frequency bandwidth and therefore in principle have more information. The wavefunction (within a pulse) received at time  $\tau$  can be written as

$$\Psi(\tau) = (2\pi)^{-1} \int_{-\infty}^{\infty} d\sigma F(\sigma) \Psi(\sigma) \exp\{-i\sigma\tau\} \quad (21)$$

where  $F(\sigma)$  is the Fourier transform of the transmitted pulse.

The intensity is then

$$I(\tau) = \Psi^*(\tau) \Psi(\tau) = (2\pi)^{-2} \int d\sigma_1 \int d\sigma_2 F^*(\sigma_1) F(\sigma_2) \Psi^*(\sigma_1) \Psi(\sigma_2) \exp\{i(\sigma_1 - \sigma_2)\tau\} \quad (22)$$

The centroid of the pulse is given by

$$\bar{\tau} = \int_{-\infty}^{\infty} \tau I(\tau) d\tau \quad (23)$$

The variance of  $\bar{\tau}$  is the observable fluctuation in pulse travel time. Since  $I(\tau)$  is second order in  $\Psi$ , the variance of  $\bar{\tau}$  is a fourth moment. Using the fact that

$$(2\pi)^{-1} \int \tau \exp\{i\sigma\tau\} d\tau = \delta'(\sigma) \quad (24)$$

we find that

$$\begin{aligned} \langle \bar{\tau}^2 \rangle &= (2\pi)^{-2} \int d\sigma_1 |F(\sigma_1)|^2 \int d\sigma_2 |F(\sigma_2)|^2 \\ &\cdot \frac{d}{du} \frac{d}{dv} \langle \Psi^*(\sigma_1 + \frac{u}{2}) \Psi(\sigma_1 - \frac{u}{2}) \\ &\cdot \Psi^*(\sigma_2 + \frac{v}{2}) \Psi(\sigma_2 - \frac{v}{2}) \rangle \Big|_{u=v=0} \end{aligned} \quad (25)$$

This fourth moment can be calculated, but the details are not appropriate here. The result is roughly that the rms travel time fluctuation has a contribution from the naive geometrical optics result (14), but multiplied by a factor that goes to zero as full saturation is approached. A second contribution comes from the inverse of the micropath bandwidth defined in Flatté *et al.* (1979). This quantity is roughly independent of acoustic frequency, is sensitive to details of the sound channel, and has a value of order 5 ms for the rays of Table I. Therefore the observation of these fluctuations should be quite feasible. A preliminary experimental result is shown in Figure 8.

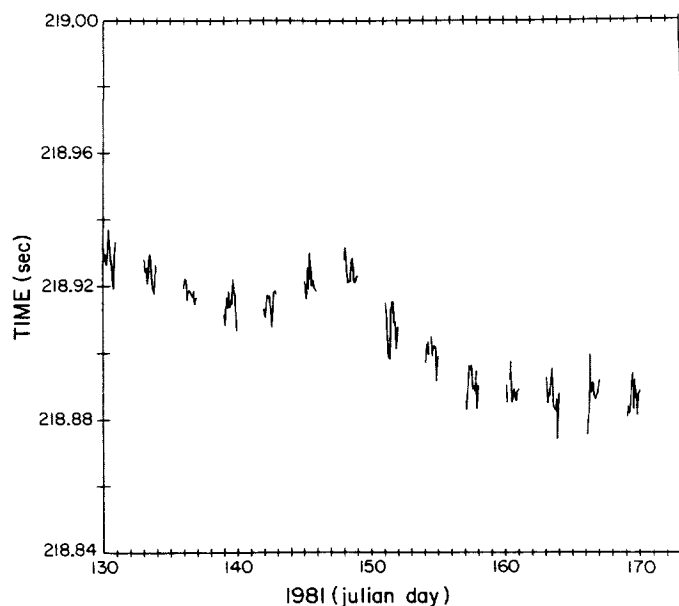

Figure 8. Observed travel-time fluctuations over a 327 km path at 220 Hz (P. Worcester, 1983).

#### Other Possible Observables

The phase differences over a short time (travel-time) or a short vertical distance (arrival angle) are only two possible observables that yield information about internal waves, although they are likely to be, for practical reasons, the first to yield useful results. No details will be given here, but other observables have been analyzed in previous sound transmission experiments.

If the phase difference is observed as a function of delay time and vertical separation, say by a vertical array gathering extensive amounts of data, then it should be clear from the third and fourth sections that tomography could be done on each individual spectral component of internal waves. That is, the geographical distribution of internal waves with a particular frequency and vertical wavenumber could in principle be found. Other observations that would give a different weighting of the internal-wave spectrum could be made by using correlations between two acoustic frequencies, by observing intensity or log-intensity fluctuations alone, or by looking at higher moments of intensity. These latter possibilities need careful investigation before raising hopes, as some of them are known to be sensitive to small details in the deterministic sound channel.

#### Conclusion

It appears feasible to determine tomographically the geographical distribution of internal-wave strength by observing fluctuations in phase along many rays through a geographical region, just as the geographical distribution of mesoscale structure can be determined by the behavior of the mean phase (or travel-time) over time scales of weeks. In the internal-wave case observations of phase fluctuations over time scales of a few minutes, or pulse travel-time fluctuations over a time scale of a few hours, will probe low-mode internal waves, while observations of phase differences between

hydrophones separated by a few meters vertically will probe high-mode internal waves. Other more complicated observations may yield further details of the internal-wave distribution. The quantitative determination of the accuracy of internal-wave tomography lies just on the horizon. If tomography of internal waves is carried out simultaneously with measurements of mesoscale ocean or atmosphere structure, the correlations between internal waves and mesoscale structure could be revealed.

#### Epilogue

This talk was given in honor of Walter Munk. Perhaps it should be noted that the Talmud forbids the expression of the full measure of a man's praise to his face. There are many psychological reasons why such a policy is a good one; it is the reason why people are somehow more comfortable with a "roast" than an encomium. Nevertheless, I would like to dedicate this idea of internal-wave tomography to Walter as an expression of appreciation for his great influence in the scientific fields of acoustics and oceanography, and for the opportunity to work closely with him over many years.

This work was supported by the Office of Naval Research, Code 420.

#### References

- The Ocean Tomography Group: D. Behringer, T. Birdsall, M. Brown, B. Cornuelle, R. Heinmiller, R. Knox, K. Metzger, W. Munk, J. Spiesberger, R. Spindel, D. Webb, P. Worcester, and C. Wunsch. 1982. A demonstration of ocean acoustic tomography. *Nature*, **299**, 121.
- Dashen, R. 1979. Path integrals for waves in random media. *J. Math Phys.*, **20**, 894 (*SRI Technical Report, JSR-76-1* (1977)).
- Esswein, R. and S.M. Flatté. 1981. Calculation of the phase-structure function density from oceanic internal waves. *J. Acoust. Soc. Am.*, **70**, 1387.
- Flatté, S.M., R. Dashen, W.H. Munk, K.M. Watson and F. Zachariassen. 1979. *Sound Transmission Through a Fluctuating Ocean*. Cambridge University Press, 299 pp.
- Flatté, S.M. 1965. Effects of changes in the earth's rotation rate on sea level. *J. Geophys. Res.*, **70**, 5189.
- Flatté, S.M. 1981. Spectra of reciprocal transmission: generalization to saturated regions. *J. Phys. Oceanogr.* **11**, 455.
- Flatté, S.M. 1983. Wave propagation through random media: contributions from ocean acoustics. *Proc. IEEE*, **71**, 1267.
- Flatté, S.M. and F.D. Tappert. 1975. Calculation of the effect of internal waves on oceanic sound transmission. *J. Acoust. Soc. Am.*, **58**, 1151.

- Garrett, C. 1983. Turning points in universal speculation on internal waves. In *A Celebration in Geophysics and Oceanography 1982. In Honor of Walter Munk*, Scripps Institution of Oceanography.
- Jeffreys, H. 1959. *The Earth*, Cambridge University Press, London.
- Tappert, F.D. 1974. Parabolic equation method in underwater acoustics. *J. Acoust. Soc. Am.*, **55**, 34A.
- Munk, W. and C. Wunsch. 1979. Ocean acoustic tomography: a scheme for large scale monitoring. *Deep-Sea Res.*, **26A**, 123.
- Munk, W.H. and F. Zachariasen. 1976. Sound propagation through a fluctuating ocean-theory and observation. *J. Acoust. Soc. Am.*, **59**, 818.
- P. Worcester. 1983. Private communication.

# THE LUCK OF WALTER MUNK

Roger Revelle

*Program in Science, Technology and Public Affairs  
University of California, San Diego  
La Jolla, California 92093*

Walter Munk was the good soldier Schweik of the American Army. He joined the Army in July 1940 and remained for nearly 18 months, in the famous Rainbow Division. Perhaps because of his outstanding leadership ability, he got promoted to be a Scout Corporal. However, this exalted rank lasted for only a few days, when he was reduced to being a private again. It happened in this way:

The duties of a Scout Corporal were to stay with his headquarters unit until the C.O. had selected the site to place the guns. Then the corporal was supposed to go back in a jeep to the place where the guns and other equipment had been parked and lead them in procession to the selected battery site. The first time Walter tried this, he became hopelessly lost, and the guns ended up far from the place they were supposed to be. The C.O. said, "That's O.K., Corporal, everyone gets lost occasionally. Let it be a lesson to you." So, the next time he had this duty, he made careful notes of trees, turnings of the trail and other landmarks so as to remember exactly the way to return with the guns.

However, they came to a cross-roads which was blocked by another unit. Walter, with commendable ingenuity, turned the column of vehicles off the road to speed around the obstacle. Unfortunately the battalion command post had been set up in the woods with drafting tables, telephone lines and other necessary paraphernalia. Walter led his vehicles right through this location, scattering drafting tables, breaking telephone lines, and causing general confusion and chaos. The battalion Commander was so angry that he called up the Captain in charge of Walter's battery and said, "You have to get rid of that corporal right away." For the remainder of his army service, Walter remained a private.

It should be pointed out that in the Army getting lost was apparently S.O.P. Walter remembers one time a few months later when the battalion commander came upon a group of trucks and said, "I thought you were supposed to be following me." The reply came back: "We are following you, sir." The battalion commander had travelled in a circle and had come back on his own men.

He remembers another time when the commanding General of the Rainbow Division talked to the troops. Pointing to his uniform, he asked, "Why is that called a uniform?" Nobody replied, so the General answered his own question, "Because it's got to be *uniform*, that's why." As so often hap-

pens with senior officers in peacetime, the General had an obsession about a completely trivial subject. The Rainbow Division started on a long trip from Camp Lewis in Washington to Camp Hunter Liggett near San Simeon in California. The vehicles stretched out over 20 miles — moving a Division is a major operation. Whenever they stopped, word came back from the general leading the convoy about the Uniform of the Day. At first it was blouses without coats, because the general was in sunshine and it was warm. In the rear of the convoy, where Walter was, they were travelling in the shade and it was cold. But they had to follow orders so they took off their coats and shivered. A few hours later, the General was in the shade and was cold, so the word came back: the Uniform of the Day will be overcoats. In Walter's part of the procession they were now in brilliant sunshine and so they put on their coats and sweltered.

Walter's immediate commander was a fat and brutal Master Sgt. named Ruebush — the kind of man who said, "When the going gets tough, the tough get going," and "The bullet that's going to hit me hasn't been made yet." He loved to embarrass Walter. One way he did this was to put him on the right end of the line when they had target practice. The man on the far left was supposed to say, "Ready on the left, sir," and then Walter was supposed to say, "Ready on the right, sir." As you know, he has never been able to say "R's" very well, so he would say, "Weady on the wight." This pronunciation caused great hilarity among his fellow soldiers, which in turn gave great pleasure to the sergeant.

This tale of the Army ended tragically for Walter's battery, but not for Sgt. Ruebush. Shortly after Pearl Harbor, the battery was sent to the Philippines and was almost completely wiped out by the Japanese. Sgt. Ruebush had gotten himself out of the Army, however, by pointing out that he was too overweight for military service. Fortunately, Harald Sverdrup and I had gotten Walter out about two weeks before Pearl Harbor, because we desperately needed his mathematical ability in the University of California Division of War Research at Point Loma.

Because they were foreign-born and had relatives in occupied Europe, both Walter and Harald Sverdrup had security clearance problems. After a few months, they left us at Point Loma and went to work for an oceanographer named Richard Seiwel who was in the Army Air Corps. Seiwel had learned

that there were going to be amphibious landings, and that one of the problems worrying the "brass" was the possibility of high surf on the landing beaches. Harald and Walter set to work to develop a system for forecasting sea, swell, and surf. This was the origin of H0601 which we saw illustrated yesterday in one of Klaus Hasselmann's slides. H0601 was classified, so that after Harald and Walter had done the work, they were unable to read their own publication because they didn't have security clearances.

I was in a sailor suit at that time as an officer in the Bureau of Ships in Washington. For the rest of World War II, it seemed to me that I spent about two days each month straightening out their security clearance problems, along with those of Alfred Redfield, who had a sister who was suspect. In this task, I was dependent upon the late, great Rawson Bennett, who later became the Chief of Naval Research. Rawson was a big, commanding-looking officer with a fierce glower. About once a month he and I would walk the length of our temporary building, about a third of a mile, to the office of the Bureau of Ships Security Officer. Rawson would glower at this poor man, and Harald and Walter and Alfred would be cleared for another month, until some new Security Officer got into the act. It's ironic to note that Walter is now the darling of the Navy Department and particularly of its most secret part, the so-called Black Navy. It's not everybody for whose birthday the Chief of Naval Research makes a special cross-country trip.

### **You've Got to be Lucky**

During the years of atomic testing in the Marshall Islands, the Scripps Institution was heavily involved in the many phases that concerned oceanography. One of the culminating tests was called IVY, in which a 20-megaton device was to be exploded. This was a thousand times the force of the bombs at Hiroshima and Nagasaki or at Bikini during the "Crossroads" operations. John Isaacs and Walter and I were worried that such a big explosion would cause a large landslide on the steep outer face of the atoll. There was evidence from bottom soundings that such landslides had occurred in the past, and since the Marshall Islands were in an earthquake-free area, we were afraid that the huge explosion might set off another landslide and its accompanying tsunami. We talked the AEC into making special preparations to evacuate the low-lying islands in the central Pacific if a tsunami did occur, and the instrumentation for the tests was mostly set up to be remotely controlled from aircraft, so that ground observers would not be inundated if a tsunami actually happened. This was quite an expensive modification of the AEC's plans.

Bill Bascom and John Isaacs built two wave recorders, which were moored on sea-mounts near Eniwetok, the idea being that these would give virtually instant warning of a tsunami, and the plans for evacuation could then be put into effect. The wave gauges were attached to small rubber rafts, and in each raft there was an old-fashioned Esterline-Angus recorder. Bill Bascom was stationed in one raft and Walter Munk in the other, and our research ship *Horizon* lay to between the two rafts. If either Bill or Walter saw a big signal on their recorder, they were supposed to alert *Horizon*,

which would then send a message to the fleet. The explosion went off on schedule. It was a terrible sight which no one who saw it will ever forget, but there was no signal on either recorder. The radioactive cloud came practically over *Horizon*, and it was decided that they must get Walter and Bill off the rafts and move out of there. Two days later, *Horizon* came back to pick up the rafts and the wave gauges. There was a huge signal on Walter's recorder, which had come two minutes after he had left the raft. This, of course, was due to a malfunction of the instrument, but Walter still has nightmares when he remembers it. Suppose he had remained on the raft and had seen the signal, alerted the *Horizon* that a tsunami had occurred, and the whole cumbersome machinery of the island evacuation had been put into motion. He wonders what he would have done, but he thinks he would have simply disappeared from sight and never come to light again. This just goes to prove my favorite motto: You've got to be lucky.

This was not the first time that Walter had spent a good many hours on a small boat. He first appeared at the Scripps Institution in the summer of 1938 when he was 20 years old and I was 29. We had decided to start an undergraduate summer fellowship program, and Walter was our first Summer Fellow. This fellowship program has continued ever since in the hope that it would produce another Walter Munk, but we have never been successful in doing so — perhaps for the obvious reason that Walter is unique.

One of the senior professors at Scripps thought it would be a good idea to obtain a week-long time series of the bottom currents in the submarine canyon off the Scripps pier. This was long before the days of automatic current meters or deep-sea-moored instruments. The currents had to be measured by hand with an Ekman Current Meter, which had to be lowered and raised every time a measurement was made, and we did this from an anchored rowboat. There were three two-man crews, each of which made measurements for about six hours, and then spelled each other off. Walter and I made up one of the three crews. Needless to say, he was a wonderful shipmate — or, rather — boatmate, and we have been together on many enterprises ever since.

By the summer of 1939, he had graduated from Caltech, and he spent a year at Scripps working with Harald Sverdrup on internal waves in the Gulf of California, for which he received the master's degree. Then he enlisted in the army, and I have told you about some of his adventures there.

### **The Hot Water Problem**

It is well known that the range of Walter's research interests is immense. But probably not many of you are aware that he has a special love for plumbing. He claims to have done all the plumbing in his and Judy's house in La Jolla. This plumbing job worked pretty well for more than 20 years until one day about seven or eight years ago they noticed a leak in the tile floor, took up the tiles, and were faced with a small geyser.

Before he started on his plumbing career, Walter spent six weeks on a ranch at Sweetwater, Nevada. Even though it was a healthy, outdoor life, he was bored. His restless mind took up a unique question. The question was: why does it

take so long, after the shower is turned on in the morning, for hot water to appear? He noticed that the water heated up very rapidly, once it began to get warm. This was an ideal subject for a hydrodynamic and thermodynamic model, which he constructed. The result was a paper in the *Journal of Applied Mechanics* under the simple title: "The Delayed Hot Water Problem". This, for all I know, is now a classic of the plumbing sciences.

Why has Walter Munk been able to do so much as an oceanographer? I think there are several reasons. For one, he has always combined observation, theory, and experimentation in a quite remarkable way. Second, most of his work has been done in collaboration with other — often younger — scientists, many of whom were his graduate students or post-doctoral fellows, and he has shown good taste in choosing his collaborators. Third, he has always been open to new ideas and new interests. I used to say that he changed the focus of his activities about once every six months. This was clearly an exaggeration, but it is true that he has worked on many different problems, always contributing new insights and new illumination.

Some of his ideas have come from unusual sources. For example, I am pretty sure that his work on the variations in the speed of Earth's rotation and in the position of the pole of rotation began in a conversation one evening long ago in his office between John Isaacs, Walter and me. We had read a piece in the science fiction magazine, *Astounding Science Fiction*, that talked about Simon Newcomb's "great empirical term". This referred to variations over several decades in the period of the moon's apparent rotation around the earth, which, of course, were due to variations in the speed of the earth's rotation. We speculated that evening that those might be caused by successive increases and decreases in the volume of ice in the Antarctic and Greenland ice caps. Thus began the prize-winning book, written jointly with Gordon

MacDonald, in which every aspect of the earth's rotation on a variety of time scales was thoroughly examined. Incidentally, possible changes in the volume of Antarctic ice are again being speculated about, in connection with the carbon dioxide problem.

That book about the earth's rotation has a special meaning for me, because it contained, in a way, my son Bill's first scientific publication. Gordon and Walter sent Bill, at the age of about fifteen, on a summer cruise to the Beaufort Sea, in the Arctic Ocean, where he measured the currents by the old fashioned method of observing a wooden float carried away from an anchored ship. Harold Jeffreys, in *The Earth*, had speculated that the principal source of tidal friction was in the Arctic Ocean, which was rumored to have tidal currents of several knots. Bill found that the wooden float barely drifted away from the ship, and that the current velocities were actually only a few centimeters per second.

There are several other reasons for Walter's extraordinary scientific accomplishments. One is that he is an artist as well as a scientist. He is concerned about the beauty of nature and of natural phenomena as well as the puzzles that nature provides for us, and he writes beautifully about his scientific work. He has remarkable prescience about the problems he works on. They are difficult problems, and hence interesting ones, but problems that are not *so* difficult that at least a partial solution cannot be found.

I have given an example of Walter's luck in telling about the tsunami that never was. But the overwhelming example of his luck is in having Judy for a wife — that cheerful, helpful, creative, loving woman, always full of ideas and projects, always ready for anything that needs to be done, gently steering and inspiring her man, in an almost unnoticeable way. If Walter Munk had never done any great scientific work, his life as a husband, a father, and a friend would still be an inspiration for the rest of us.

# REMARKS IN CELEBRATION OF WALTER MUNK'S 65TH BIRTHDAY

Henry Stommel

*Woods Hole Oceanographic Institution  
Woods Hole, Massachusetts 02543*

Because the remarks that I will make here are not to be recorded or preserved in imperishable print — "off the record" so to speak — I can take some liberties in mentioning events and personalities which would otherwise be unthinkable, secure in the knowledge that they — the remarks, I mean — will soon join the snows of yesteryear.\*

It was thirty-three years, four months ago, almost exactly a third of a century, when I visited Walter here at Scripps. Walter was then living in one of the now vanished white frame cottages along the shore. I was living in a garage apartment somewhere in the village, and Albert Defant was living with Ludovic Lek, his pre-war Dutch graduate student who, like Walter, had done a Ph.D. thesis on internal waves, but who had turned into a La Jolla real estate operator and was living in luxury on Mount Soledad. I well remember an expedition that summer with Walter, Teddy Bullard, their wives, and Tim Shepard to ascend San Geronio — a picturesque mountain somewhere east of Los Angeles. We walked up to a lovely valley — Walter, Teddy and Tim went on to scale the summit — others including myself, elected to wait for them at Edelweiss hut. That is always the way it has been. Some are destined to scale the heights; others remain at near-surface pressure. My old Ford was not much better. Twice I tried to drive up to Mt. Palomar, but boiled over and broke fan belts both times. I could see I could never compete with Walter in California and went home.

A unit of thirty-three and a third years is both a long time and a short time. Some of you, who have lived here during most of these years, are sometimes a little discomposd by the growth, the new buildings, the urbanization. To an occasional visitor like myself the cove, the shore line, parts of the village, the Pacific Ocean, the climate, all seem very much the same, and in some sense one might assert that there has been relatively little change. Relative to what? Why, to the change in the past before 1949, where only three third-centuries would bring us back to the Goldrush; or ten third-centuries reach back to 1616, the year when Galileo received his first warning.

Over the years Woods Hole and Scripps have grown to be more alike, I think, than they were in 1949. In those days Woods Hole was a loose association of amateurs, whereas Scripps was noticeably more professional. Being associated with the University, its purchasing and financial offices were more rigid. Toward the end of my 1949 visit I went to the shipping office to send off a foot-locker by railway-express collect. I saw a stencil cutting machine there and some scraps of the cardboard used for cutting stencils lying on a shelf next to it. I asked the attendant whether I could use one of them and he said yes, but that I would need a purchase order. I asked him for a blank purchase order form and his reply was that he could not issue them singly but only in pads. But when I asked for a pad he said he would need a purchase order to give me a pad.

During 1949 Walter fell into the toils of this inexorable system himself. It concerned the financing of the Sverdrup Anniversary Volume in the Journal of Marine Research of 1948. A special Sverdrup Fund had been set up at the business office at Scripps, and early in 1949 it had become clear that there was a cost overrun due to a substantial increase in the cost of paper and printer's charges, and the Sverdrup Fund was in the red. And red was a very bad color in the University of California in 1949. During all of that year Walter wrote to possible donors, and by its end had reduced the deficit, but not to zero. Mr. John C. Kirby, of the business office, was adamant: the books must be balanced. Only one way remained for Walter to extricate himself from the toils: to pay the balance out of his own pocket.

Now it is not an altogether simple matter to give money to the University of California. The terms of the gift must conform to certain rules, and before it can be accepted there is a very definite procedure which must be adhered to. A form entitled "Report of the Tender of a Gift" must be filed by the responsible officer of the university to whom the gift is originally offered. This form is submitted for approval by the Provost, the Business Manager, the President and the Regents. Decisions must be recorded as to whether the gift requires acknowledgment by the President of the University, in addition to that by the Secretary of the Regents, the latter of which is automatic. After two months of approvals and acknowledgments, Walter's gift was accepted, and at last the books balanced. The amount was \$1.33.

\*Editors' Note. This remark should not be taken as typical of Stommel's prognostic skills. He succumbed to some arm-twisting by the editors.



All this was long ago, and one realizes that nothing like this could occur today.

Walter himself has written that the three great influences on his scientific career were Harald Sverdrup, Roger Revelle and Carl Eckart, all at one time directors at Scripps. Through Sverdrup and Eckart, Walter was linked indirectly with the great European geophysical tradition of Bjerknes, Hergesell, von Ficker and the great physical tradition of Sommerfeld.

Sverdrup imbued Walter with the belief that knowledge grows from a deep study of data, and I think Walter's beautiful series of studies of tides and waves using novel spectral data-processing methods is an eloquent testament to this influence. Revelle inspired Walter with a wideness and generosity of vision, spanning the full breadth of the human predicament, particularly as it relates to natural resources, climate, and population pressure. And I think Revelle's informal style of academic management, his receptiveness to criticism, his optimism about human destiny, all had a powerful effect on Walter's own open style of administration at IGPP.

Eckart's influence on Walter was powerfully astringent. Basically a shy, kind and gentle man, Eckart brought to Scripps a kind of mathematical formality to which Scripps oceanographers had not been fully exposed. Once, when praising Dave Bonner, Eckart spoke of him as "a strong character with a creatively skeptical approach to research". You will note that creative is the modifying adverb, skeptical the adjective, and for a man of such precision of mind, this is not a randomly chosen phraseology. Walter has written of Eckart's years at Scripps that although Eckart began with the belief that he would solve the problems of oceanography, he concluded that they were unsolvable. Eckart's formidable lectures both inspired and intimidated his students, and I think frightened some away from thinking about ocean currents.

A certain tension between rigor and vigor is characteristic of science: it is a tug-of-war to which we each must find our own accommodation. It looms largest to one who teaches. Edwin Bidwell Wilson, George Carrier's mentor, wrote in the preface of one of his texts an elaborate apologia for not overemphasizing modern questions of rigor, and concluded with the words: "That the compositor should have set 'vigor' where 'rigor' was written, might appear more amusing were it not for the suggested antithesis that there may be many who set rigor where vigor should be." Walter's encounters with Eckart were like those of a great comet with the planet Jupiter. His orbit was perturbed into that of an ellipse with greater major axis and some of us feared it might be hyperbolic. For a while he veered away from conventional oceanography into general geophysics and the theory of the earth's rotation and returned to our midst to concentrate upon tide and wave phenomena, where representative data records can be obtained, thorough data-processing pursued, and firmly based physical interpretations created — as Walter has indeed done so beautifully over the years.

How chilling Eckart's skepticism could be, was dramatically revealed to me when in the mid-fifties Carl-Gustaf Rossby arrived at Woods Hole, visibly shaken after an interview with Eckart, and literally wondering if his own scientific career had been worthwhile.

Men with very great formal powers do not always seem to realize what a profound effect they have on their younger colleagues.

One of the perils of a scientist's life is the danger of being overpowered by a colleague of superior formal abilities. Once, on the train from Princeton to New York, Bernhard Haurwitz and I and a young professor of applied mathematics from Brown University were recovering from a rather spectacular interview with von Neumann and the young professor was very depressed by the comparison of his own abilities with von Neumann's dazzling display. Haurwitz soothed him with the story of how he, while at lunch at the Faculty Club of NYU, had once expressed his own sense of depression after a von Neumann interview, and Richard Courant had replied: "That's funny! It's just the way he makes me feel, too!". With such words from such a man, we can all take heart and believe that there is something of value that we can all contribute.

The scope and originality of Walter's contributions is well attested to by the program in this symposium, where so many of the subjects represent developments of ideas and studies pioneered by him. Walter's own sense of precision and skepticism has been so tempered by his zest and enthusiasm that it has inspired many to follow the leads and thoughts which he first discovered. There is little need for me to attempt to review his contributions and accomplishments once again, when it has already been so admirably done these past two days. But I would like to stress one last outstanding characteristic feature of Walter's works: Walter's impeccable craftsmanship. His papers are beautifully composed and written. They have balance and counterpoint; they have a compelling logical structure and clarity; they are a joy to read.

Do you know that T.V. advertisement about soft drinks that asserts "Coke is it" and another in which a well-known celebrity, as they say in California, says in a Dixie dialect: "They all compare themselves to Coke... number 29, number 41,... but you know that Coke is number one. That's why they compare themselves to Coke... I see you nodding... yes-sir, Coke is number one." Well Walter has been number one for all these years, and whether we want to or not all of us compare ourselves to him, at one time or another. When I was called to the chair of oceanography at Harvard, it was only after Walter had declined it.

Of course, I am not the only victim of Walter's preeminence. It has happened to others before, and will happen to more of us in the future.

Let us imagine the following scene: You have been invited to an ambassadorial reception in Venice. Arriving in a gondola by torchlight you step into a grand palazzo between the striped posts at its watergate. Perhaps you are the guest of honor, and an oceanographer of great distinction. Perhaps you are Klaus Hasselmann. You make your way amongst the elegant guests, shaking hands, introducing yourself, with assurance and grace. The main salon is crowded with the elite of the Italian academic world; the crystal chandeliers are ablaze, the champagne flows. Your eye catches the sight of a beautiful girl standing alone under a Tintoretto — a vision of

loveliness. Unconsciously you slowly make your way in her direction, smiling, and exchanging greetings with old acquaintances all the while. The orchestra strikes up a waltz by

Strauss. You approach her, bow, politely ask her for this dance. As she extends her hand, her eyes melt and she says: "You're Walter Munk aren't you?".



*This picture of Arthur and me (on the fertility chair) was taken in our patio by Fritz Goro just after the MOHOLE trials at Guadalupe Island (1961).*

